

RD74LVC16244B

16-bit Buffers / Line Drivers with 3-state Outputs

REJ03D0527-0100

Rev.1.00

Mar. 14, 2005

Description

The RD74LVC16244B has sixteen line drivers with three state outputs in a 48 pin package. This device is a non inverting buffer and has two active low enables ($\overline{1G}$ to $\overline{4G}$). Each enable independently controls four buffers. Low voltage and high-speed operation is suitable at the battery drive product (note type personal computer) and low power consumption extends the life of a battery for long time operation.

Features

- $V_{CC} = 1.65 \text{ V to } 5.5 \text{ V}$
- All inputs $V_{IH} (\text{Max.}) = 5.5 \text{ V} (@V_{CC} = 0 \text{ V to } 5.5 \text{ V})$
- All outputs $V_{OUT} (\text{Max.}) = 5.5 \text{ V} (@V_{CC} = 0 \text{ V or output off state})$
- Typical V_{OL} ground bounce $< 0.8 \text{ V} (@V_{CC} = 3.3 \text{ V, } T_a = 25^\circ\text{C})$
- Typical V_{OH} undershoot $> 2.0 \text{ V} (@V_{CC} = 3.3 \text{ V, } T_a = 25^\circ\text{C})$
- High output current
 - $\pm 4 \text{ mA} (@V_{CC} = 1.65 \text{ V})$
 - $\pm 8 \text{ mA} (@V_{CC} = 2.3 \text{ V})$
 - $\pm 12 \text{ mA} (@V_{CC} = 2.7 \text{ V})$
 - $\pm 24 \text{ mA} (@V_{CC} = 3.0 \text{ V to } 5.5 \text{ V})$
- Ordering Information

Part Name	Package Type	Package Code (Previous Code)	Package Abbreviation	Taping Abbreviation (Quantity)
RD74LVC16244BTEL	TSSOP-48 pin	PTSP0048KA-A (TTP-48DBV)	T	EL (1,000 pcs/reel)

Function Table

Inputs		Output Y
\overline{G}	A	
H	X	Z
L	H	H
L	L	L

H: High level

L: Low level

X: Immaterial

Z: High impedance

Pin Arrangement

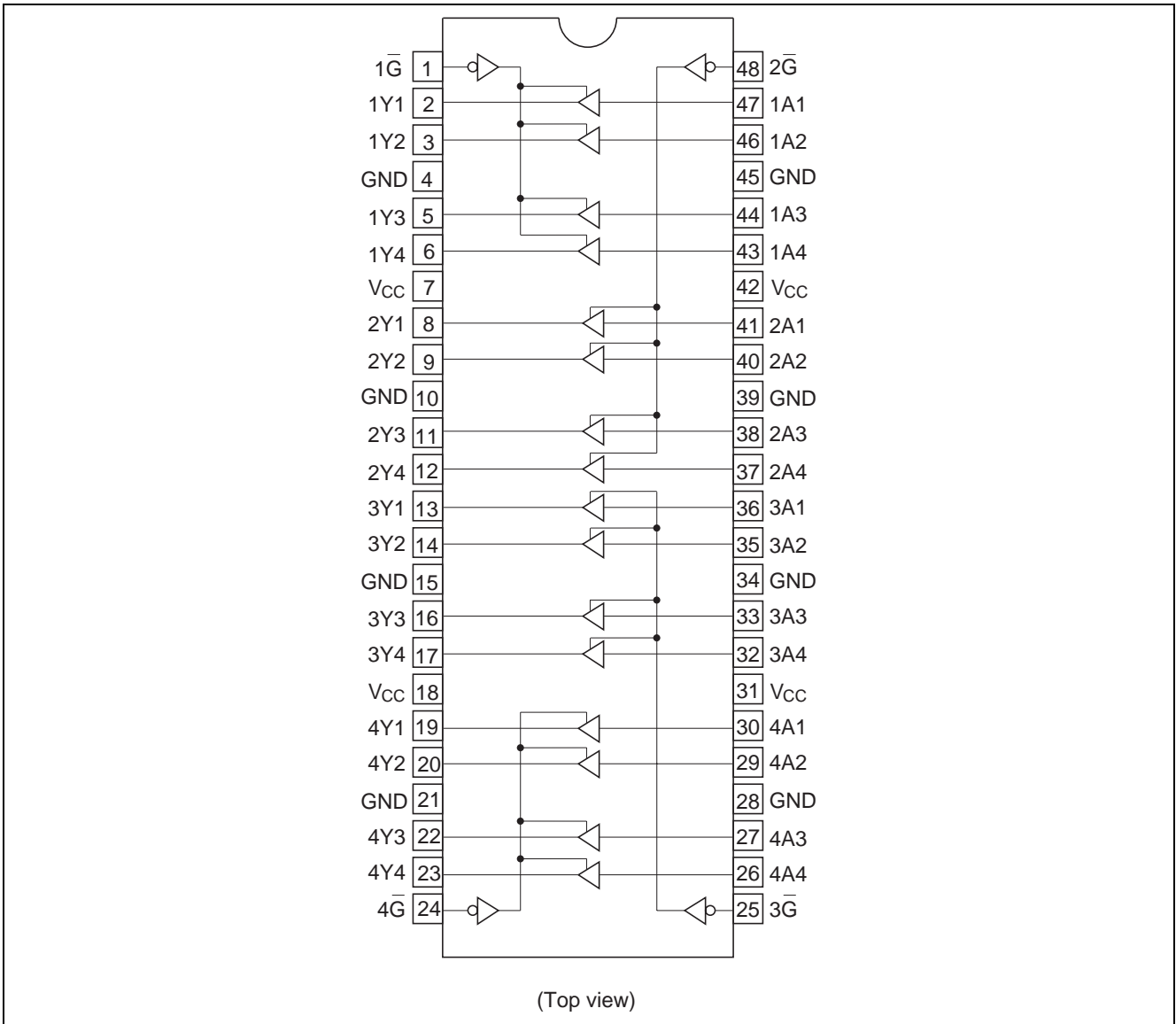

Absolute Maximum Ratings

Item	Symbol	Ratings	Unit	Conditions
Supply voltage	V_{CC}	-0.5 to 7.0	V	
Input diode current	I_{IK}	-50	mA	$V_I = -0.5$ V
Input voltage	V_I	-0.5 to 7.0	V	
Output diode current	I_{OK}	-50	mA	$V_O = -0.5$ V
		50		$V_O = V_{CC} + 0.5$ V
Output voltage	V_O	-0.5 to $V_{CC} + 0.5$	V	Output "H" or "L"
		-0.5 to 7.0		Output "Z" or $V_{CC}: OFF$
Output current	I_O	± 50	mA	
V_{CC} , GND current / pin	I_{CC} or I_{GND}	100	mA	
Storage temperature	T_{stg}	-65 to +150	$^{\circ}C$	

Note: The absolute maximum ratings are values, which must not individually be exceeded, and furthermore, no two of which may be realized at the same time.

Recommended Operating Conditions

Item	Symbol	Ratings	Unit	Conditions
Supply voltage	V_{CC}	1.5 to 5.5	V	Data hold
		1.65 to 5.5		At operation
Input / Output voltage	V_I	0 to 5.5	V	\bar{G} , A
	V_O	0 to V_{CC}		Output "H" or "L"
		0 to 5.5		Output "Z" or $V_{CC}: OFF$
Operating temperature	T_a	-40 to 85	$^{\circ}C$	
Output current	I_{OH}	-4	mA	$V_{CC} = 1.65$ V
		-8		$V_{CC} = 2.3$ V
		-12		$V_{CC} = 2.7$ V
		-24		$V_{CC} = 3.0$ V to 5.5 V
	I_{OL}	4	mA	$V_{CC} = 1.65$ V
		8		$V_{CC} = 2.3$ V
		12		$V_{CC} = 2.7$ V
		24		$V_{CC} = 3.0$ V to 5.5 V
Input rise / fall time ^{*1}	t_r, t_f	20	ns/V	$V_{CC} = 1.65$ V to 2.7 V
		10		$V_{CC} = 3.0$ V to 5.5 V

Notes: 1. This item guarantees maximum limit when one input switches.

Waveform: Refer to test circuit of switching characteristics.

Electrical Characteristics

Item	Symbol	V _{CC} (V)	Ta = -40 to 85°C		Unit	Test Conditions
			Min	Max		
Input voltage	V _{IH}	1.65 to 1.95	V _{CC} ×0.65	—	V	
		2.3 to 2.7	1.7	—		
		2.7 to 3.6	2.0	—		
		4.5 to 5.5	V _{CC} ×0.7	—		
	V _{IL}	1.65 to 1.95	—	V _{CC} ×0.35	V	
		2.3 to 2.7	—	0.7		
		2.7 to 3.6	—	0.8		
		4.5 to 5.5	—	V _{CC} ×0.3		
Output voltage	V _{OH}	1.65 to 5.5	V _{CC} -0.2	—	V	I _{OH} = -100 μA
		1.65	1.2	—		I _{OH} = -4 mA
		2.3	1.7	—		I _{OH} = -8 mA
		2.7	2.2	—		I _{OH} = -12 mA
		3.0	2.4	—		
		3.0	2.2	—		I _{OH} = -24 mA
		4.5	3.8	—		
	V _{OL}	1.65 to 5.5	—	0.2	V	I _{OL} = 100 μA
		1.65	—	0.45		I _{OL} = 4 mA
		2.3	—	0.7		I _{OL} = 8 mA
		2.7	—	0.4		I _{OL} = 12 mA
		3.0	—	0.55		
		4.5	—	0.55		I _{OL} = 24 mA
	Input current	I _{IN}	0 to 5.5	—	±5.0	μA
Output leak current	I _{OFF}	0	—	±5.0	μA	V _{IN} / V _{OUT} = 5.5 V
Off state output current	I _{oz}	2.7 to 5.5	—	±5.0	μA	V _{IN} = V _{CC} or GND V _O = 5.5 V or GND
Quiescent supply current	I _{CC}	2.7 to 3.6	—	±10	μA	V _{IN} = 3.6 V to 5.5 V
		2.7 to 5.5	—	10		V _{IN} = V _{CC} or GND
	ΔI _{CC}	2.7 to 3.6	—	500	μA	V _{IN} = one input at (V _{CC} -0.6)V, other inputs at V _{CC} or GND

Switching Characteristics

Item	Symbol	V _{CC} (V)	Ta = -40 to 85°C			Unit	From (Input)	To (Output)
			Min	Typ	Max			
Propagation delay time	t _{PLH}	1.8±0.15	1.0	—	10.9	ns	A	Y
	t _{PHL}	2.5±0.2	1.0	—	7.9			
		2.7	1.0	—	5.8			
		3.3±0.3	1.5	—	5.2			
		5.0±0.5	1.0	—	4.0			
Output enable time	t _{ZH}	1.8±0.15	1.0	—	12.6	ns	\bar{G}	Y
	t _{ZL}	2.5±0.2	1.0	—	9.6			
		2.7	1.0	—	8.2			
		3.3±0.3	1.5	—	7.5			
		5.0±0.5	1.0	—	5.5			
Output disable time	t _{HZ}	1.8±0.15	1.0	—	12.1	ns	\bar{G}	Y
	t _{LZ}	2.5±0.2	1.0	—	7.8			
		2.7	1.0	—	7.7			
		3.3±0.3	1.5	—	7.0			
		5.0±0.5	1.0	—	6.0			
Between output pins skew*1	t _{OSLH}	1.8±0.15	—	—	—	ns		
	t _{OSHL}	2.5±0.2	—	—	—			
		2.7	—	—	—			
		3.3±0.3	—	—	1.0			
		5.0±0.5	—	—	1.0			
Input capacitance	C _{IN}	3.3	—	4.0	—	pF		
Output capacitance	C _O	3.3	—	8.0	—	pF		

Note: 1. This parameter is characterized but not tested.

$$t_{OSLH} = |t_{PLHm} - t_{PLHn}|, t_{OSHL} = |t_{PHLm} - t_{PHLn}|$$

Operating Characteristics

Item	Symbol	V _{CC} (V)	Ta = 25°C			Unit	Test conditions
			Min	Typ	Max		
Power dissipation Capacitance	C _{PD}	1.8	—	25.0	—	pF	f = 10 MHz
		2.5	—	25.0	—		
		3.3	—	27.0	—		
		5.0	—	32.0	—		

Test Circuit

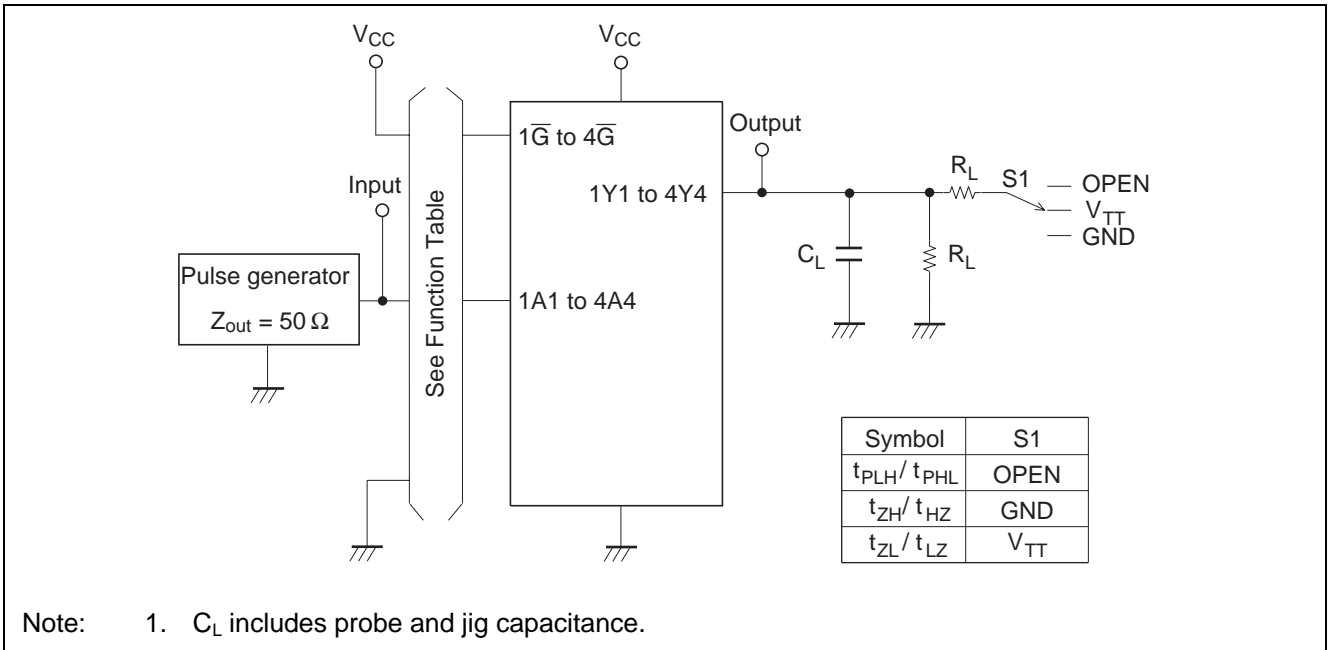

Waveforms – 1

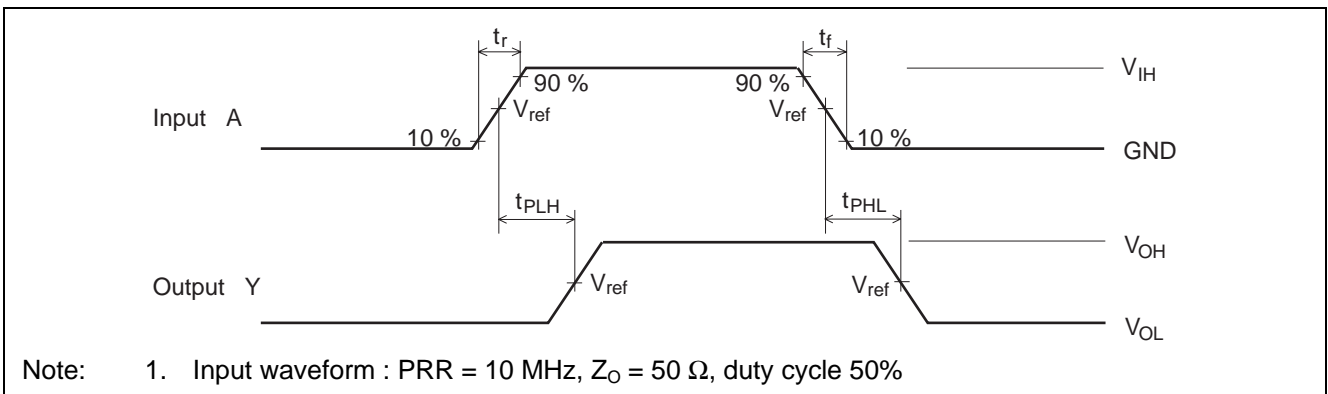

Waveforms – 2

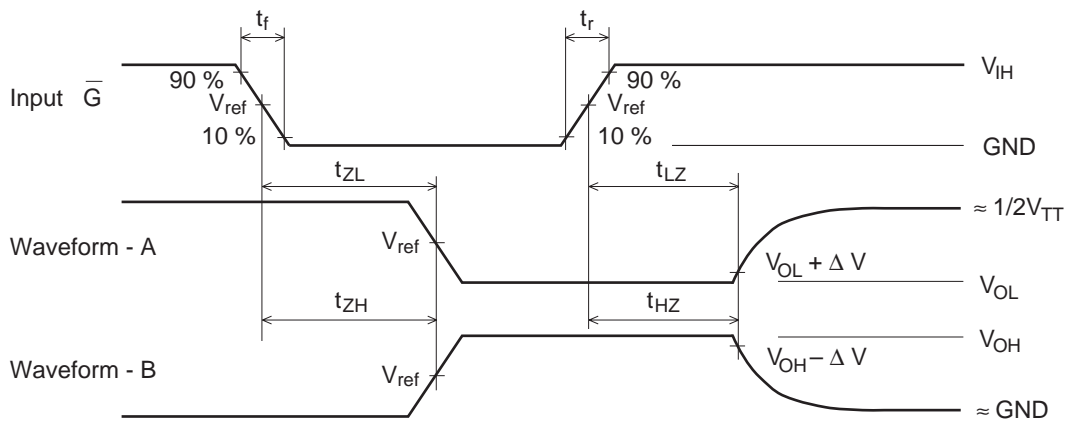

V _{CC} (V)	INPUTS		V _{ref}	V _{TT}	C _L	R _L	ΔV
	V _I	t _r /t _f					
V _{CC} = 1.8±0.15 V	V _{CC}	≤ 2 ns	1/2 V _{CC}	2× V _{CC}	30 pF	1.0 kΩ	0.15 V
V _{CC} = 2.5±0.2 V	V _{CC}	≤ 2 ns	1/2 V _{CC}	2× V _{CC}	30 pF	500 Ω	0.15 V
V _{CC} = 2.7 V	2.7 V	≤ 2.5 ns	1.5 V	6 V	50 pF	500 Ω	0.3 V
V _{CC} = 3.3±0.3 V	2.7 V	≤ 2.5 ns	1.5 V	6 V	50 pF	500 Ω	0.3 V
V _{CC} = 5.0±0.5 V	V _{CC}	≤ 2.5 ns	1/2 V _{CC}	2× V _{CC}	50 pF	500 Ω	0.3 V

- Notes:
1. Input waveform : PRR = 10 MHz, Z_O = 50 Ω, duty cycle 50%
 2. Waveform – A shows input conditions such that the output is "L" level when enable by the output control.
 3. Waveform – B shows input conditions such that the output is "H" level when enable by the output control.

Package Dimensions

JEITA Package Code P-TSSOP48-6.1x12.5-0.50	RENESAS Code PTSP0048KA-A	Previous Code TTP-48DBV	MASS[Typ.] 0.2g
---	------------------------------	----------------------------	--------------------

NOTE)
 1. DIMENSIONS*1 (Nom)*AND*2*
 DO NOT INCLUDE MOLD FLASH
 2. DIMENSION*3*DOES NOT
 INCLUDE TRIM OFFSET.

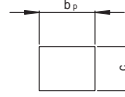
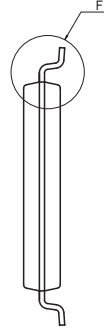
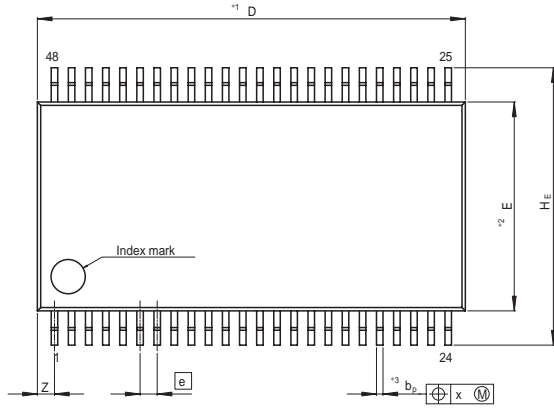

Terminal cross section
(Ni/Pd/Au plating)

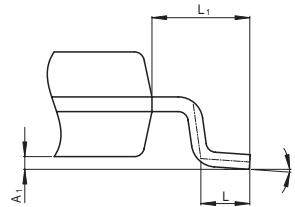
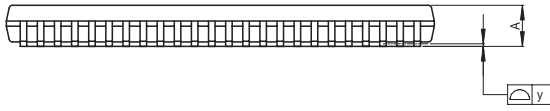

Detail F

Reference Symbol	Dimension in Millimeters		
	Min	Nom	Max
D	—	12.5	12.7
E	—	6.10	—
A ₂	—	—	—
A ₁	0.08	0.13	0.18
A	—	—	1.20
b _p	0.14	0.19	0.24
b ₁	—	—	—
c	0.10	0.15	0.20
c ₁	—	—	—
θ	0°	—	8°
H _E	7.90	8.10	8.30
e	—	0.50	—
x	—	—	0.08
y	—	—	0.10
Z	—	—	0.65
L	0.4	0.5	0.6
L ₁	—	1.0	—

Renesas Technology Corp. Sales Strategic Planning Div. Nippon Bldg., 2-6-2, Ohte-machi, Chiyoda-ku, Tokyo 100-0004, Japan

Keep safety first in your circuit designs!

1. Renesas Technology Corp. puts the maximum effort into making semiconductor products better and more reliable, but there is always the possibility that trouble may occur with them. Trouble with semiconductors may lead to personal injury, fire or property damage.
Remember to give due consideration to safety when making your circuit designs, with appropriate measures such as (i) placement of substitutive, auxiliary circuits, (ii) use of nonflammable material or (iii) prevention against any malfunction or mishap.

Notes regarding these materials

1. These materials are intended as a reference to assist our customers in the selection of the Renesas Technology Corp. product best suited to the customer's application; they do not convey any license under any intellectual property rights, or any other rights, belonging to Renesas Technology Corp. or a third party.
2. Renesas Technology Corp. assumes no responsibility for any damage, or infringement of any third-party's rights, originating in the use of any product data, diagrams, charts, programs, algorithms, or circuit application examples contained in these materials.
3. All information contained in these materials, including product data, diagrams, charts, programs and algorithms represents information on products at the time of publication of these materials, and are subject to change by Renesas Technology Corp. without notice due to product improvements or other reasons. It is therefore recommended that customers contact Renesas Technology Corp. or an authorized Renesas Technology Corp. product distributor for the latest product information before purchasing a product listed herein.
The information described here may contain technical inaccuracies or typographical errors.
Renesas Technology Corp. assumes no responsibility for any damage, liability, or other loss rising from these inaccuracies or errors.
Please also pay attention to information published by Renesas Technology Corp. by various means, including the Renesas Technology Corp. Semiconductor home page (<http://www.renesas.com>).
4. When using any or all of the information contained in these materials, including product data, diagrams, charts, programs, and algorithms, please be sure to evaluate all information as a total system before making a final decision on the applicability of the information and products. Renesas Technology Corp. assumes no responsibility for any damage, liability or other loss resulting from the information contained herein.
5. Renesas Technology Corp. semiconductors are not designed or manufactured for use in a device or system that is used under circumstances in which human life is potentially at stake. Please contact Renesas Technology Corp. or an authorized Renesas Technology Corp. product distributor when considering the use of a product contained herein for any specific purposes, such as apparatus or systems for transportation, vehicular, medical, aerospace, nuclear, or undersea repeater use.
6. The prior written approval of Renesas Technology Corp. is necessary to reprint or reproduce in whole or in part these materials.
7. If these products or technologies are subject to the Japanese export control restrictions, they must be exported under a license from the Japanese government and cannot be imported into a country other than the approved destination.
Any diversion or reexport contrary to the export control laws and regulations of Japan and/or the country of destination is prohibited.
8. Please contact Renesas Technology Corp. for further details on these materials or the products contained therein.



RENESAS SALES OFFICES

<http://www.renesas.com>

Refer to "<http://www.renesas.com/en/network>" for the latest and detailed information.

Renesas Technology America, Inc.

450 Holger Way, San Jose, CA 95134-1368, U.S.A
Tel: <1> (408) 382-7500, Fax: <1> (408) 382-7501

Renesas Technology Europe Limited

Dukes Meadow, Millboard Road, Bourne End, Buckinghamshire, SL8 5FH, U.K.
Tel: <44> (1628) 585-100, Fax: <44> (1628) 585-900

Renesas Technology Hong Kong Ltd.

7th Floor, North Tower, World Finance Centre, Harbour City, 1 Canton Road, Tsimshatsui, Kowloon, Hong Kong
Tel: <852> 2265-6688, Fax: <852> 2730-6071

Renesas Technology Taiwan Co., Ltd.

10th Floor, No.99, Fushing North Road, Taipei, Taiwan
Tel: <886> (2) 2715-2888, Fax: <886> (2) 2713-2999

Renesas Technology (Shanghai) Co., Ltd.

Unit2607 Ruijing Building, No.205 Maoming Road (S), Shanghai 200020, China
Tel: <86> (21) 6472-1001, Fax: <86> (21) 6415-2952

Renesas Technology Singapore Pte. Ltd.

1 Harbour Front Avenue, #06-10, Keppel Bay Tower, Singapore 098632
Tel: <65> 6213-0200, Fax: <65> 6278-8001