



**ELECTROSTATIC SENSITIVE DEVICE**  
OBSERVE HANDLING PRECAUTIONS

MITSUBISHI RF POWER MOS FET

# RD12MVP1

RoHS Compliance, Silicon MOSFET Power Transistor, 175MHz, 10W

## DESCRIPTION

RD12MVP1 is a MOS FET type transistor specifically designed for VHF RF power amplifiers applications.

## FEATURES

- High Power Gain  
Pout>10W, Gp>13dB@Vdd=7.2V,f=175MHz
- High Efficiency: 55%min. (175MHz)
- No gate protection diode

## APPLICATION

For output stage of high power amplifiers in VHF band mobile radio sets.

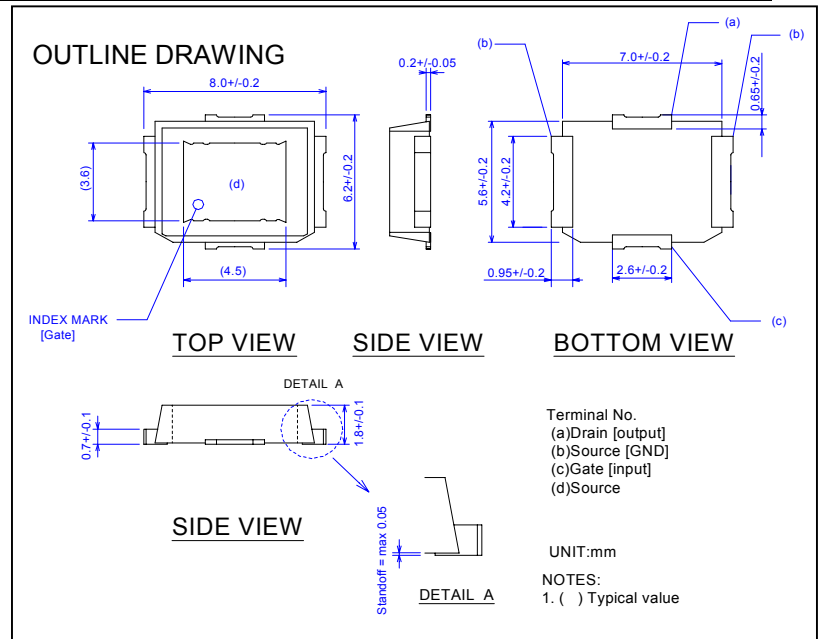

## RoHS COMPLIANT

RD12MVP1 is a RoHS compliant product.

RoHS compliance is indicating by the letter "G" after the Lot Marking. This product includes the lead in high melting temperature type solders. However, it applicable to the following exceptions of RoHS Directions.

1. Lead in high melting temperature type solders (i.e. tin-lead older alloys containing more than 85% lead.)

## ABSOLUTE MAXIMUM RATINGS

(Tc=25°C, UNLESS OTHERWISE NOTED)

SYMBOL	PARAMETER	CONDITIONS	RATINGS	UNIT
Vdss	Drain to Source Voltage	VGS=0V	60	V
Vgss	Gate to Source Voltage	VDS=0V	-5 to +20	V
ID	Drain Current		4.0	A
Pin	Input Power	Zg=Zl=50Ω	1.0	W
Pch	Channel Dissipation	Tc=25°C	125	W
Tj	Junction Temperature		+150	°C
Tstg	Storage Temperature		-40 to +125	°C
Rthj-c	Thermal Resistance	Junction to Case	1.5	°C/W

Note: Above parameters are guaranteed independently.

## ELECTRICAL CHARACTERISTICS (Tc=25°C, UNLESS OTHERWISE NOTED)

SYMBOL	PARAMETER	CONDITIONS	LIMITS			UNIT
			MIN.	TYP.	MAX.	
Idss	Zero Gate Voltage Drain Current	VDS=17V, VGS=0V	-	-	10	μA
Igss	Gate to Source Leak Current	VGS=10V, VDS=0V	-	-	1.0	μA
VTH	Gate Threshold Voltage	VDS=12V, IDS=1mA	1.8	-	4.4	V
Pout	Output Power	f=175MHz, VDD=7.2V	10	12	-	W
ηD	Drain Efficiency	Pin=0.5W, Idq=1.0A	55	57	-	%
VSWR	Load VSWR tolerance	VDD=9.5V, Po=10W (Pin Control) f=175MHz, Idq=1.0A, Zg=50Ω Load VSWR=20:1 (All Phase)	No destroy			-

Note: Above parameters, ratings, limits and conditions are subject to change.



ELECTROSTATIC SENSITIVE DEVICE  
OBSERVE HANDLING PRECAUTIONS

MITSUBISHI RF POWER MOS FET

# RD12MVP1

RoHS Compliance, Silicon MOSFET Power Transistor, 175MHz, 10W

## TYPICAL CHARACTERISTICS

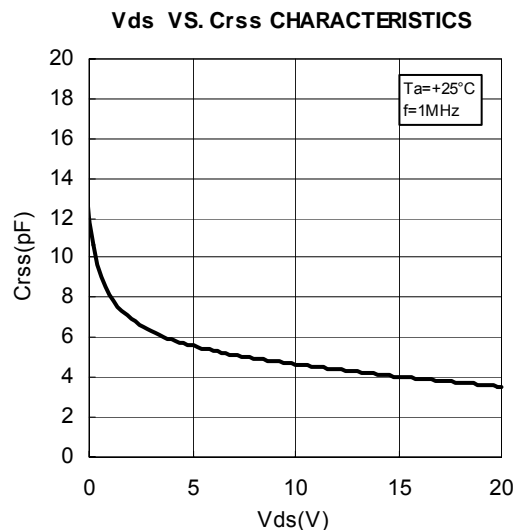
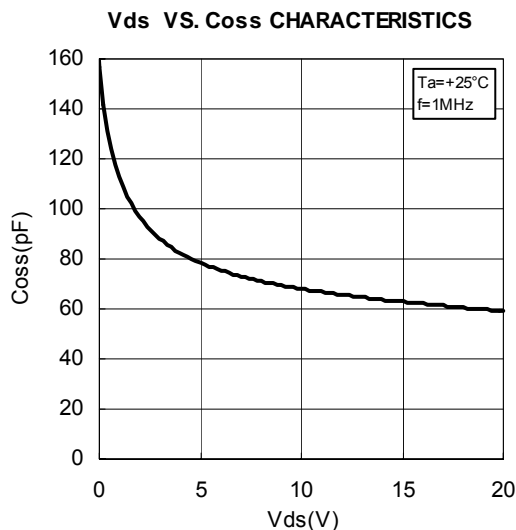
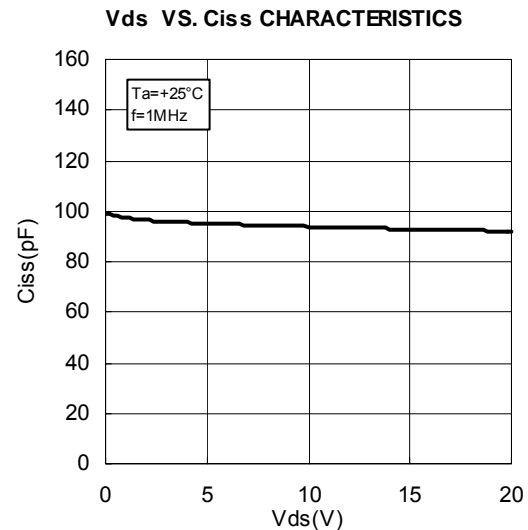
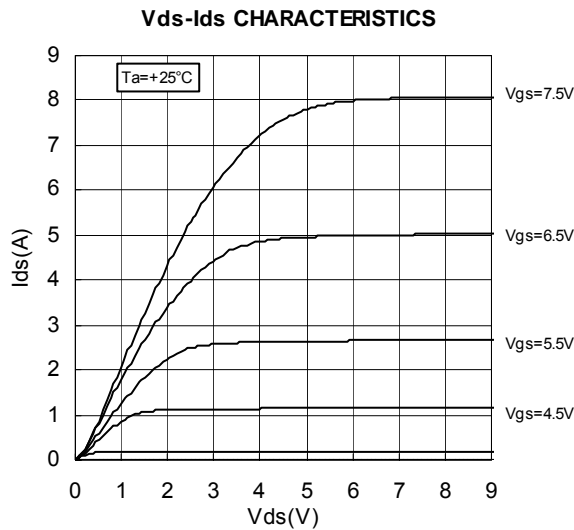
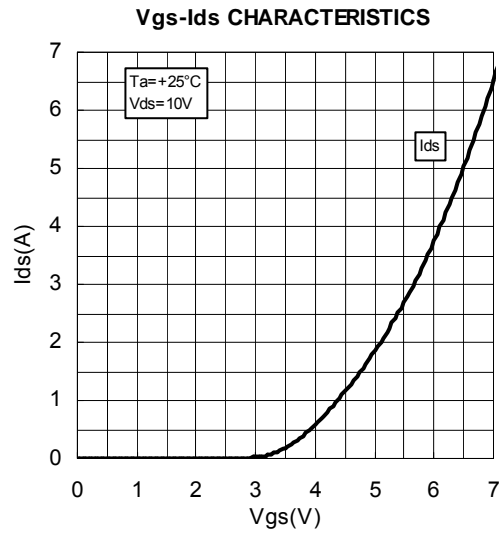
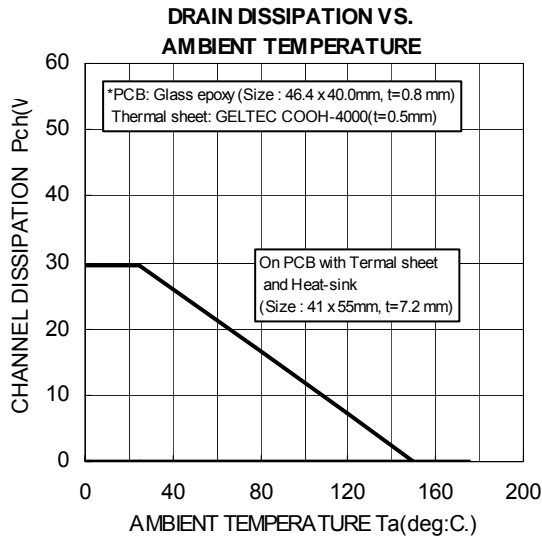



ELECTROSTATIC SENSITIVE DEVICE  
OBSERVE HANDLING PRECAUTIONS

MITSUBISHI RF POWER MOS FET

# RD12MVP1

RoHS Compliance, Silicon MOSFET Power Transistor, 175MHz, 10W

## TYPICAL CHARACTERISTICS

Pin-Po CHARACTERISTICS @f=175MHz

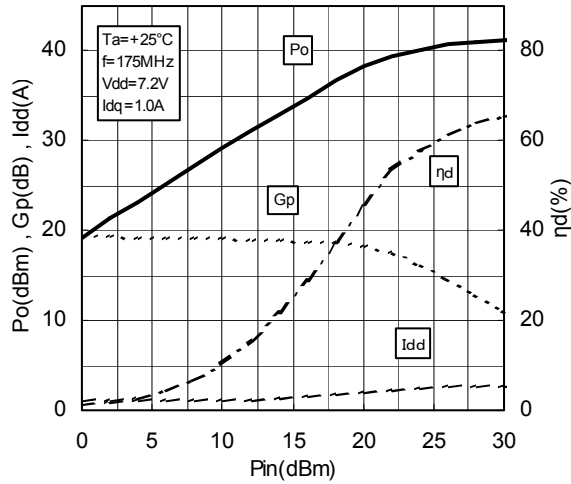

Pin-Po CHARACTERISTICS @f=175MHz

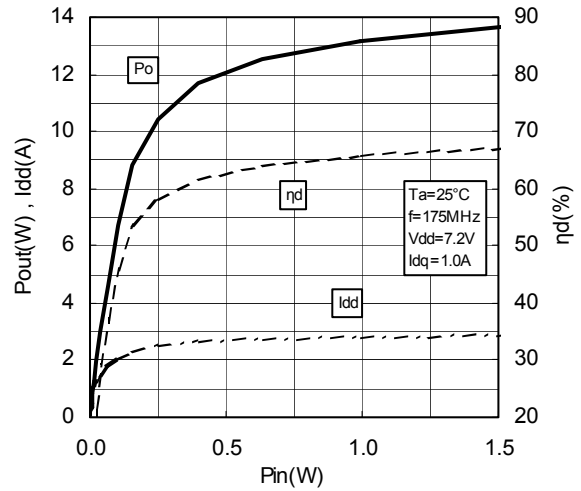

Vdd-Po CHARACTERISTICS @f=175MHz

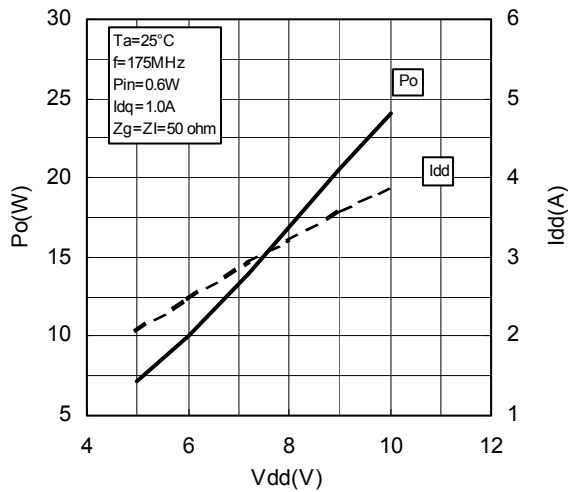

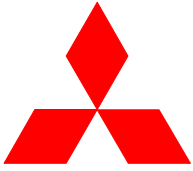

ELECTROSTATIC SENSITIVE DEVICE  
OBSERVE HANDLING PRECAUTIONS

MITSUBISHI RF POWER MOS FET

# RD12MVP1

RoHS Compliance, Silicon MOSFET Power Transistor, 175MHz, 10W

## TEST CIRCUIT (f=175MHz)

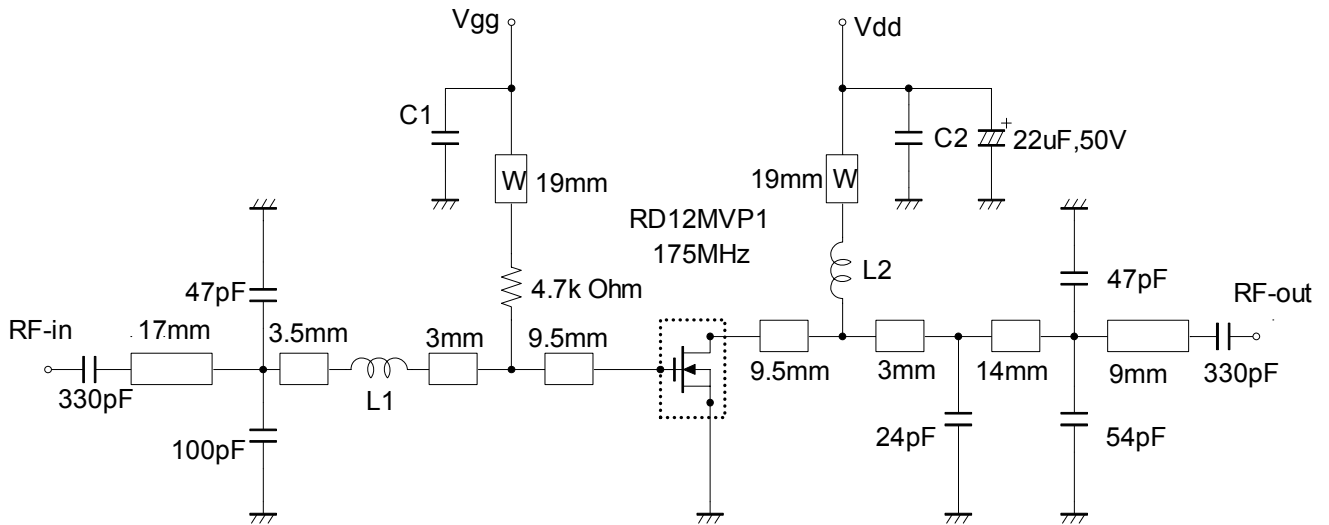

Note: Board material= glass-Epoxy Substrate  
Micro strip line width=1.3mm/50OHM, er=4.8, t=0.8mm  
W: Line width=1.0mm

L1: 10.8nH, 4 Turns, D: 0.43mm, 1.66mm (outside diameter)  
L2: 43.7nH, 6 Turns, D: 0.43mm, 2.46mm (outside diameter)  
C1, C2: 2200pF

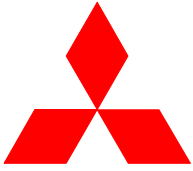

ELECTROSTATIC SENSITIVE DEVICE  
OBSERVE HANDLING PRECAUTIONS

MITSUBISHI RF POWER MOS FET

# RD12MVP1

RoHS Compliance, Silicon MOSFET Power Transistor, 175MHz, 10W

RD12MVP1 S-PARAMETER DATA (@V<sub>dd</sub>=7.2V, I<sub>d</sub>=500mA)

Freq. [MHz]	S11		S21		S12		S22	
	(mag)	(ang)	(mag)	(ang)	(mag)	(ang)	(mag)	(ang)
100	0.782	-165.5	6.105	69.0	0.024	-16.8	0.743	-162.7
125	0.801	-166.9	4.716	62.4	0.022	-20.5	0.766	-164.0
150	0.817	-168.0	3.724	56.4	0.021	-25.7	0.783	-165.6
175	0.833	-168.8	3.023	51.6	0.019	-27.3	0.799	-166.4
200	0.847	-169.7	2.519	47.5	0.016	-31.1	0.825	-167.2
225	0.860	-170.6	2.137	43.5	0.015	-30.0	0.845	-167.7
250	0.872	-171.6	1.828	39.6	0.013	-34.0	0.864	-168.6
275	0.882	-172.4	1.569	36.0	0.012	-30.9	0.871	-169.6
300	0.894	-173.0	1.361	33.4	0.010	-31.7	0.879	-170.4
325	0.901	-173.5	1.193	31.0	0.008	-24.1	0.888	-171.3
350	0.910	-174.2	1.062	28.5	0.007	-20.9	0.901	-172.1
375	0.917	-175.2	0.947	25.9	0.006	-13.8	0.915	-172.9
400	0.918	-176.1	0.844	23.5	0.005	-1.5	0.918	-173.6
425	0.923	-176.7	0.756	21.5	0.004	16.0	0.917	-174.4
450	0.930	-177.2	0.683	20.4	0.005	35.4	0.922	-174.8
475	0.933	-177.7	0.623	18.7	0.005	43.3	0.928	-175.5
500	0.938	-178.1	0.568	17.2	0.006	53.6	0.935	-176.3
525	0.939	-178.8	0.520	15.7	0.007	58.5	0.943	-176.8
550	0.942	-179.3	0.477	14.3	0.008	63.6	0.941	-177.1
575	0.943	179.7	0.439	13.3	0.009	68.8	0.941	-177.8
600	0.946	179.5	0.407	12.2	0.011	73.9	0.945	-178.3
625	0.950	179.1	0.378	11.3	0.011	72.4	0.949	-178.9
650	0.950	178.8	0.350	10.4	0.012	74.8	0.950	-179.5
675	0.953	178.3	0.327	9.8	0.013	79.1	0.952	-179.8
700	0.952	177.9	0.306	8.9	0.014	77.0	0.954	179.8
725	0.954	177.5	0.286	8.3	0.015	77.2	0.951	179.4
750	0.955	176.9	0.268	7.7	0.016	79.2	0.955	178.9
775	0.954	176.4	0.252	7.2	0.018	78.9	0.957	178.6
800	0.955	176.3	0.238	7.0	0.018	79.9	0.958	178.1
825	0.958	175.9	0.225	6.4	0.020	78.9	0.961	177.7
850	0.958	175.6	0.213	5.9	0.021	80.1	0.954	177.5
875	0.956	175.1	0.203	5.5	0.022	79.0	0.960	177.3
900	0.958	174.5	0.192	5.3	0.023	79.6	0.958	176.8
925	0.956	174.3	0.182	5.3	0.024	79.3	0.962	176.4
950	0.958	174.0	0.175	5.3	0.025	78.3	0.964	176.0
975	0.957	173.8	0.166	5.2	0.026	80.7	0.964	176.0
1000	0.959	173.6	0.158	5.7	0.026	78.8	0.962	175.8



**ELECTROSTATIC SENSITIVE DEVICE**  
OBSERVE HANDLING PRECAUTIONS

MITSUBISHI RF POWER MOS FET

# RD12MVP1

RoHS Compliance, Silicon MOSFET Power Transistor, 175MHz, 10W

## RD12MVP1 S-PARAMETER DATA (@Vdd=7.2V, Id=900mA)

Freq. [MHz]	S11		S21		S12		S22	
	(mag)	(ang)	(mag)	(ang)	(mag)	(ang)	(mag)	(ang)
100	0.799	-169.4	5.980	72.2	0.021	-11.2	0.757	-166.6
125	0.813	-170.7	4.690	65.9	0.020	-14.9	0.780	-167.5
150	0.825	-171.3	3.726	60.1	0.019	-17.2	0.785	-168.8
175	0.835	-171.9	3.045	55.9	0.017	-21.5	0.794	-169.3
200	0.846	-172.5	2.569	52.3	0.016	-22.4	0.821	-169.3
225	0.857	-173.4	2.206	48.4	0.015	-21.1	0.846	-169.5
250	0.868	-174.3	1.904	44.3	0.013	-21.2	0.863	-170.4
275	0.877	-174.9	1.648	40.7	0.011	-21.3	0.864	-170.9
300	0.886	-175.3	1.436	38.2	0.010	-19.9	0.864	-171.4
325	0.895	-175.7	1.270	35.8	0.009	-15.8	0.876	-172.0
350	0.900	-176.4	1.141	33.1	0.008	-11.9	0.891	-172.6
375	0.907	-177.3	1.023	30.4	0.007	-7.2	0.906	-173.1
400	0.909	-178.1	0.917	27.7	0.007	1.3	0.915	-173.9
425	0.913	-178.7	0.820	25.8	0.005	20.2	0.908	-174.4
450	0.921	-179.1	0.745	24.6	0.006	27.4	0.910	-174.5
475	0.925	-179.6	0.683	23.0	0.006	36.9	0.921	-175.2
500	0.932	-180.0	0.627	21.2	0.007	50.8	0.933	-175.9
525	0.931	179.2	0.575	19.4	0.007	53.6	0.937	-176.6
550	0.933	178.6	0.529	18.1	0.008	57.3	0.935	-176.8
575	0.937	178.0	0.486	16.6	0.009	67.9	0.931	-177.0
600	0.943	177.7	0.452	16.1	0.010	70.4	0.935	-177.4
625	0.943	177.3	0.422	14.9	0.011	70.9	0.945	-178.0
650	0.946	177.0	0.391	14.0	0.013	73.8	0.948	-178.6
675	0.947	176.6	0.366	12.7	0.013	75.6	0.946	-179.0
700	0.946	175.9	0.341	12.0	0.015	76.9	0.946	-179.3
725	0.951	175.5	0.322	11.3	0.015	75.8	0.945	-179.6
750	0.949	175.0	0.302	10.5	0.016	76.4	0.949	179.9
775	0.951	174.7	0.284	9.6	0.017	77.8	0.952	179.4
800	0.950	174.5	0.269	9.3	0.019	79.0	0.955	179.0
825	0.956	174.3	0.253	9.2	0.020	77.8	0.954	178.9
850	0.956	173.7	0.240	8.7	0.020	78.7	0.950	178.9
875	0.956	173.3	0.228	7.9	0.021	78.7	0.952	178.4
900	0.953	172.8	0.218	7.1	0.023	77.3	0.953	177.9
925	0.948	172.5	0.206	6.6	0.024	76.8	0.958	177.4
950	0.955	172.2	0.196	7.0	0.024	78.3	0.959	177.3
975	0.955	172.0	0.186	7.3	0.025	78.6	0.958	177.4
1000	0.957	171.8	0.178	7.1	0.026	79.1	0.956	177.1



**ELECTROSTATIC SENSITIVE DEVICE**  
OBSERVE HANDLING PRECAUTIONS

**MITSUBISHI RF POWER MOS FET**

**RD12MVP1**

**RoHS Compliance, Silicon MOSFET Power Transistor, 175MHz, 10W**

---

**Keep safety first in your circuit designs!**

Mitsubishi Electric Corporation puts the maximum effort into making semiconductor products better and more reliable, but there is always the possibility that trouble may occur with them. Trouble with semiconductors may lead to personal injury, fire or property damage. Remember to give due consideration to safety when making your circuit designs, with appropriate measures such as (i) placement of substitutive, auxiliary circuits, (ii) use of non-flammable material or (iii) prevention against any malfunction or mishap.

**Warning!**

Do not use the device at the exceeded the maximum rating condition. In case of plastic molded devices, the exceeded maximum rating condition may cause blowout, smoldering or catch fire of the molding resin due to extreme short current flow between the drain and the source of the device. These results causes in fire or injury.