

Powerex, Inc., 200 Hillis Street, Youngwood, Pennsylvania 15697-1800 (412) 925-7272
 Powerex, Europe, S.A. 428 Avenue G. Durand, BP107, 72003 Le Mans, France (43) 41.14.14

High Power General Purpose Rectifier 7000 Amperes Average 600 Volts

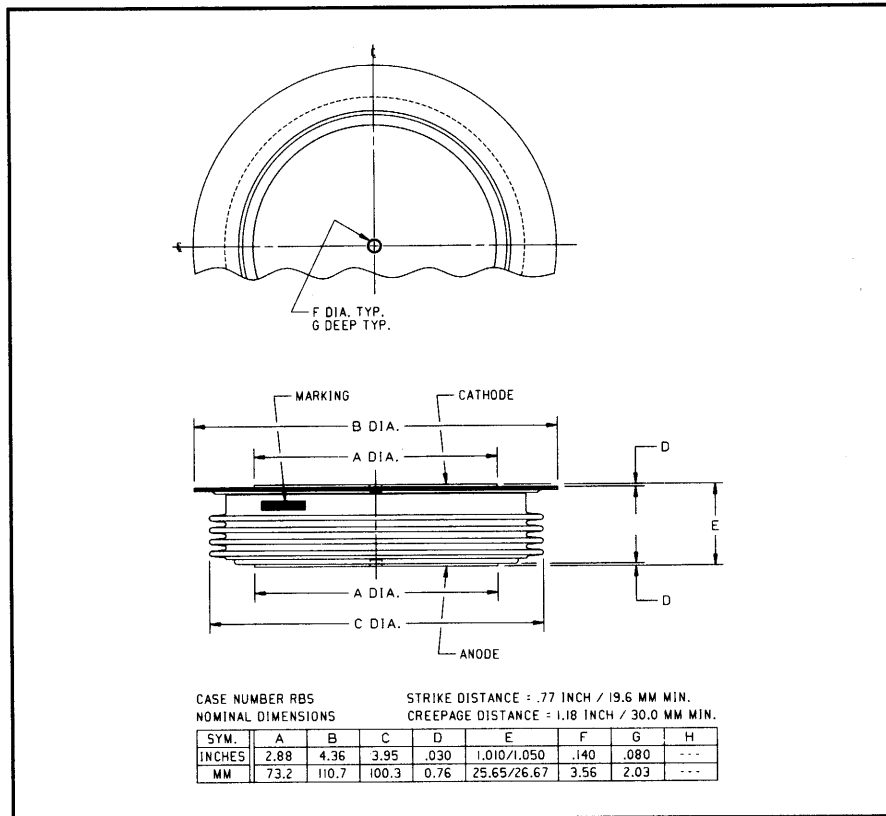

RBS8 7000A (Outline Drawing)

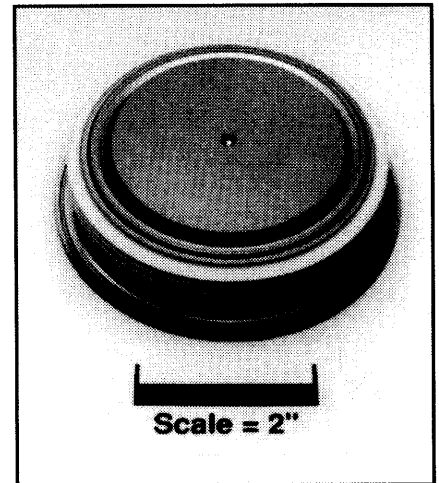

RBS8 7000A
High Power
General Purpose Rectifier
7000 Amperes Average, 600 Volts

Description:

The RBS8 is a low voltage, high current rectifier in a thin, low profile package with improved thermal capability. Powerex High Power Rectifiers are designed for use in applications requiring reliable general purpose rectification of high currents.

Features:

- Low Forward Voltage
- Low Thermal Impedance
- Low Profile Package
- Hermetic Packaging
- Excellent Surge and I^2t Ratings

Applications:

- Power Supplies
- AC and DC Motor Control
- VAR Generators

Ordering Information:

Select the complete 8 digit part number you desire from the table below.

Type	Voltage	Current	Typical Recovery Time
	V_{RRM} (Volts)	$I_T(av)$ (A)	t_{rr} (μ sec)
RBS8	02 04 06	70	XX
	200V 400V 600V	7000A	25 μ sec



Powerex, Inc., 200 Hillis Street, Youngwood, Pennsylvania 15697-1800 (412) 925-7272
Powerex, Europe, S.A. 428 Avenue G. Durand, BP107, 72003 Le Mans, France (43) 41.14.14

RBS8 7000A
High Power General Purpose Rectifier
7000 Amperes Average, 600 Volts

Absolute Maximum Ratings

Characteristics	Symbol	RBS8 7000A	Units
Non-repetitive Transient Peak Reverse Voltage	V_{RSM}	$V_{RRM} + 200V$	Volts
RMS Forward Current, $T_C = 79^\circ C$	$I_{F(rms)}$	11000	Amperes
Average Current 180° Sine Wave, $T_C = 79^\circ C$	$I_{F(av)}$	7000	Amperes
RMS Forward Current, $T_C = 55^\circ C$	$I_{F(rms)}$	12440	Amperes
Average Current 180° Sine Wave, $T_C = 55^\circ C$	$I_{F(av)}$	7925	Amperes
Peak One Cycle Surge Forward Current (Non-repetitive) 60Hz	I_{fsm}	60000	Amperes
Peak One Cycle Surge Forward Current (Non-repetitive) 50Hz	I_{fsm}	55000	Amperes
I^2t (for Fusing) for One Cycle, 60Hz	I^2t	15×10^6	A^2sec
Operating Temperature	T_j	-40 to +175°C	°C
Storage Temperature	T_{stg}	-40 to +175°C	°C
Approximate Weight		2.5	lb.
		1.1	kg
Mounting Force		6000 to 10000	lb.
		26.6 to 44.4	kN



Powerex, Inc., 200 Hillis Street, Youngwood, Pennsylvania 15697-1800 (412) 925-7272
 Powerex, Europe, S.A. 428 Avenue G. Durand, BP107, 72003 Le Mans, France (43) 41.14.14

RBS8 7000A

High Power General Purpose Rectifier
 7000 Amperes Average, 600 Volts

Electrical Characteristics, $T_j = 25^\circ\text{C}$ Unless Otherwise Specified

Characteristics	Symbol	Test Conditions	Min.	Typ.	Max.	Units
Peak Reverse Leakage Current	I_{RRM}	$T_j = 175^\circ\text{C}, V_R = V_{RRM}$			100	mA
Forward Voltage Drop	V_{FM}	$I_{FM} = 3000\text{A}, \text{Duty Cycle} < 0.1\%$			0.90	Volts
Threshold Voltage, Low-level	$V_{(TO)1}$	$T_j = 125^\circ\text{C}, I = 15\%, I_{T(av)}$ to $\pi I_{T(av)}$			0.64564	Volts
Slope Resistance, Low-level	r_{T1}				0.04421	m Ω
Threshold Voltage, High-level	$V_{(TO)2}$	$T_j = 125^\circ\text{C}, I = \pi I_{T(av)}$ to I_{TSM}			0.64880	Volts
Slope Resistance, High-level	r_{T2}				0.04539	m Ω
V_{TM} Coefficients, Low-level		$T_j = 125^\circ\text{C}, I = 15\% I_{T(av)}$ to $\pi I_{T(av)}$				
					$A_1 = 0.042466$	
					$B_1 = 0.12757$	
					$C_1 = 7.653\text{E-}05$	
					$D_1 = -0.009271$	
V_{TM} Coefficients, High-level		$T_j = 125^\circ\text{C}, I = \pi I_{T(av)}$ to I_{TSM}				
					$A_2 = 1.7705$	
					$B_2 = -0.24559$	
					$C_2 = 6.379\text{E-}06$	
					$D_2 = 0.01468$	
Typical Reverse Recovery Time	t_{rr}	$T_C = 25^\circ\text{C}, I_{FM} = 1500\text{A},$ $di_F/dt = 25\text{A}/\mu\text{sec}$		25		μsec

Thermal Characteristics

Maximum Thermal Resistance, Double Sided Cooling

Junction-to-Case	$R_{\theta(j-c)}$		0.0095	$^\circ\text{C/W}$
Case-to-Sink	$R_{\theta(c-s)}$		0.002	$^\circ\text{C/W}$

Powerex, Inc., 200 Hillis Street, Youngwood, Pennsylvania 15697-1800 (412) 925-7272
 Powerex, Europe, S.A. 428 Avenue G. Durand, BP107, 72003 Le Mans, France (43) 41.14.14

RBS8 7000A
 High Power General Purpose Rectifier
 7000 Amperes Average, 600 Volts

Maximum On-State Forward Voltage Drop
 ($T_J = 175^\circ\text{C}$)

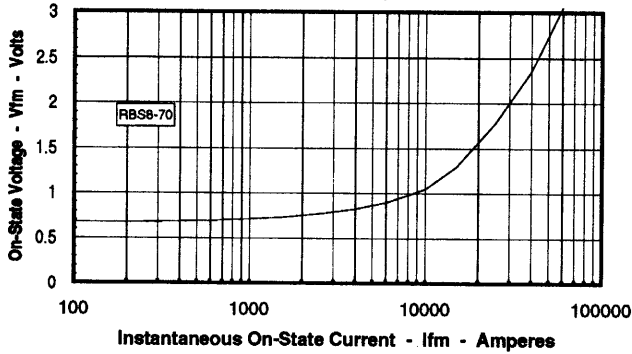

Maximum Transient Thermal Impedance
 (Junction to Case)

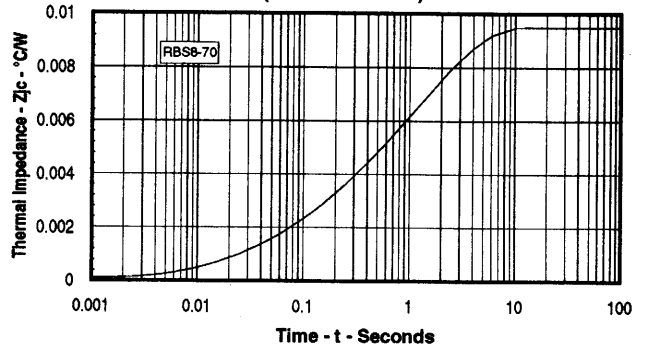

Maximum On-State Power Dissipation
 (Sinusoidal Waveform)

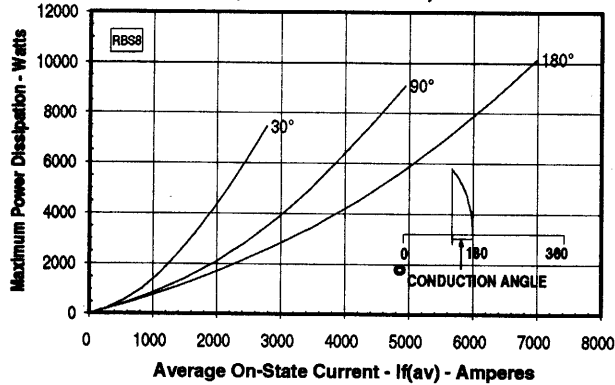

Maximum Allowable Case Temperature
 (Sinusoidal Waveform)

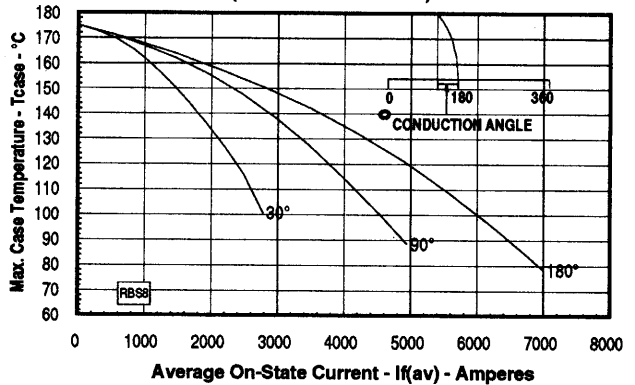

Maximum On-State Power Dissipation
 (Rectangular Waveform)

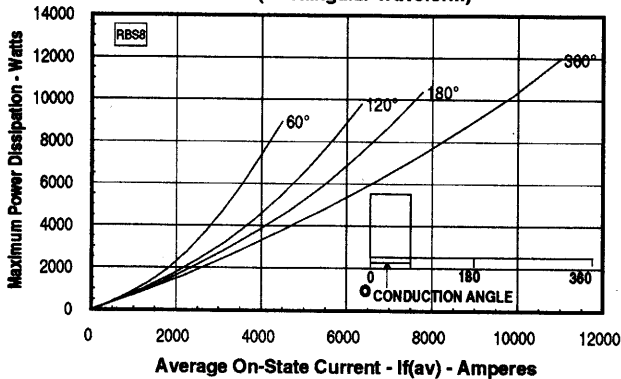

Maximum Allowable Case Temperature
 (Rectangular Waveform)

