

InGaAs (Cs) Photocathode, Wide Spectral Response, 51mm (2") Dia., Head-on Type
For Photon Counting : Low Dark Counts, Excellent P.H.D.

■ APPLICATIONS

- Raman Spectroscopy
- Fluorescent Spectroscopy
- Astrophysical Measurement
- Laser Detection

■ FEATURES

Wide Spectral Response

R3310-02 300 to 1040nm
R4330-02 160 to 1040nm

High Quantum Efficiency in IR 0.25% at 1 μ m

Fast Rise Time 3.0ns at 1500V

Excellent Single Photoelectron

Pulse Height Distribution

..... Peak to Valley Ratio 2.3 (at -20°C)

Low Dark Counts 30cps Typ. (at -20°C)



Hamamatsu R3310-02 and R4330-02 are 51mm (2") diameter head-on type photomultiplier tubes having InGaAs (Cs) photocathodes, and linear focused CuBeO dynodes. The InGaAs (Cs) photocathode allows high sensitivity over a wide spectral range up to 1040nm.

The R3310-02 and the R4330-02 are selected for photon counting, and they feature low dark counts and excellent pulse height distribution (PHD) of single photoelectrons.

■ GENERAL

Parameter	Description/Value	Unit
Spectral Response		
R3310-02	300 to 1040	nm
R4330-02	160 to 1040	nm
Wavelength of Maximum Response	400	nm
Photocathode		
Material	InGaAs(Cs)	—
Minimum Effective Area	10 X 10	mm
Mode	Opaque	—
Window Material		
R3310-02	Borosilicate glass (K-free)	—
R4330-02	Synthetic silica glass	—
Dynode		
Secondary Emitting Surface	Cu-BeO	—
Structure	Linear Focused	—
Number of Stages	10	—
Direct Interelectrode Capacitances		
Anode to Last Dynode	Approx. 2	pF
Anode to All Other Electrodes	Approx. 3	pF
Base	21-pin Base	—
Suitable Socket	E678-21C (Supplied) E678-21D (Option)	—
Weight		
R3310-02	110	g
R4330-02	93	g

Figure 1: Typical Spectral Response

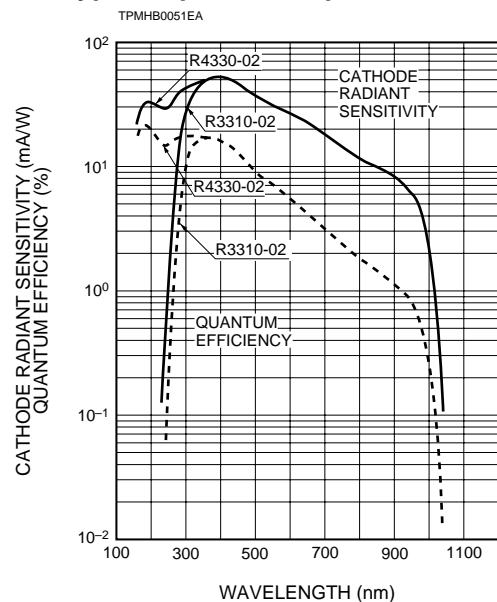

PHOTOMULTIPLIER TUBES R3310-02, R4330-02

MAXIMUM RATINGS (Absolute Maximum Values)

Parameter	Value	Unit
Supply Voltage		
Between Anode and Cathode	2200	Vdc
Between Anode and Last Dynode	250	Vdc
Average Anode Current ④	1	μA
Average Pulse Count Rate ⑤	6 × 10 ⁶	cps
Average Cathode Current ⑥	10	pA
Ambient Temperature ⑦	-80 to +50	°C

CHARACTERISTICS (at 25°C)

Parameter	Min.	Typ.	Max.	Unit
Cathode Sensitivity ⑧				
Quantum Efficiency				
at 253.7nm (Hg-Line) R4330 Series	—	15	—	%
at 1000nm	0.13	0.25	—	%
Luminous ⑨	80	150	—	μA/lm
Radiant at 253.7nm (Hg-Line) R4330 Series	—	30	—	mA/W
at 852.1nm (Cs-Line)	—	9.4	—	mA/W
at 900nm	—	8.1	—	mA/W
at 1000nm	1.1	2	—	mA/W
Red/White Ratio ⑩	—	0.4	—	—
Anode Sensitivity ⑪				
Luminous ⑫	15	50	—	A/lm
Radiant at 253.7nm (Hg-Line) R4330 Series	—	1.0 × 10 ⁴	—	A/W
at 852.1nm (Cs-Line)	—	3.1 × 10 ³	—	A/W
at 900nm	—	2.7 × 10 ³	—	A/W
at 1000nm	—	6.6 × 10 ²	—	A/W
Gain ⑬	—	3.3 × 10 ⁵	—	—
Equivalent Anode Dark Current ⑭	—	5	20	nA
Anode Dark Current ⑮	—	30	150	cps
Single Photoelectron PHD (Peak to Valley Ratio)	—	2.3	—	—
Time Response ⑯				
Anode Pulse Rise Time ⑰	—	3.0	—	ns
Electron Transit Time ⑱	—	23	—	ns

NOTES

- ④ Averaged over any interval of 30 seconds maximum.
 ⑤ Measured at single photoelectron level. The discriminator level is set at valley point.
 ⑥ In practical operation, the cathode current should be lower than 2pA to prevent shortening the life of the photocathode.
 ⑦ For cooling operation, another ceramic socket, type number E678-21D is recommended, because the teflon socket type number E678-21C supplied with the tube is not suitable for cooling operation due to its high thermal expansion coefficient. Alternatively, it is recommended to solder a resistor, capacitor, etc. directly on stem pins using a socket contact (100-2520S) supplied by Winchester.
 ⑧ Supply voltage is 150 volts between the cathode and all other electrodes.
 ⑨ The light source is a tungsten filament lamp operated at a distribution temperature of 2856K.
 ⑩ The quotient of the cathode sensitivity measured with the light source is the same as Note ⑧ passing through a red filter (Toshiba R-68) divided by the cathode luminous sensitivity without the red filter.
 ⑪ Measured with supply voltage and voltage distribution ratio in Table 1.
 ⑫ Measured with supply voltage to provide the anode luminous sensitivity of 40 (A/lm) and the voltage distribution ratio in Table 1 after 30 minutes storage in the darkness.
 ⑬ Measured with supply voltage that gives 2 × 10⁶ gain and with the voltage distribution ratio shown in Table 1 after one hour storage in the cooler set at -20°C.

- The discriminator is set at 1/3 of a single photoelectron level.
 ⑰ The rise time is the time it takes the output pulse to rise from 10% to 90% of the peak amplitude when the entire photocathode is illuminated by a delta function light pulse.
 ⑱ The electron transit time is the interval between the arrival of a delta function light pulse at the entrance window of the tube and the time when the output pulse reaches the peak amplitude. In measurement the entire photocathode is illuminated.

Warning—Personal Safety Hazards
 Electrical Shock — Operating voltages applied to this device present a shock hazard.

Table 1: Voltage Distribution Ratio

Electrodes	K	Dy1	Dy2	Dy3	Dy4	Dy5	Dy6	Dy7	Dy8	Dy9	Dy10	P
Distribution Ratio	3	1.5	1	1	1	1	1	1	1	1	1	1

Supply Voltage : 1500Vdc, K : Cathode, Dy : Dynode, P : Anode

Figure 2: Typical Single Photoelectron Pulse Height Distribution

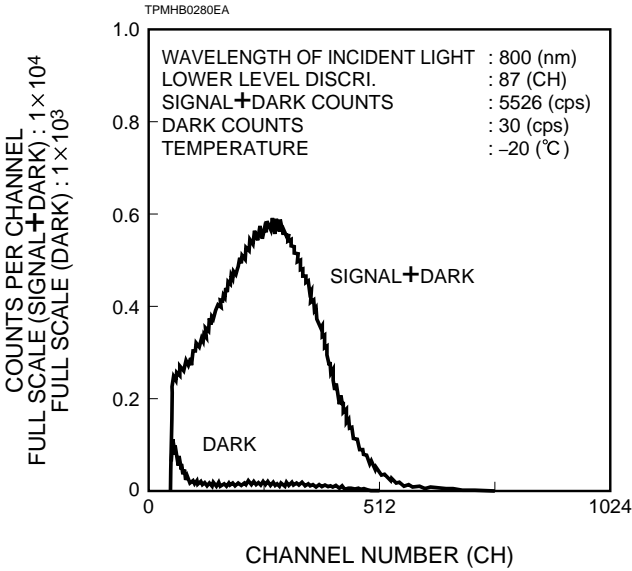

Figure 3: Typical Gain

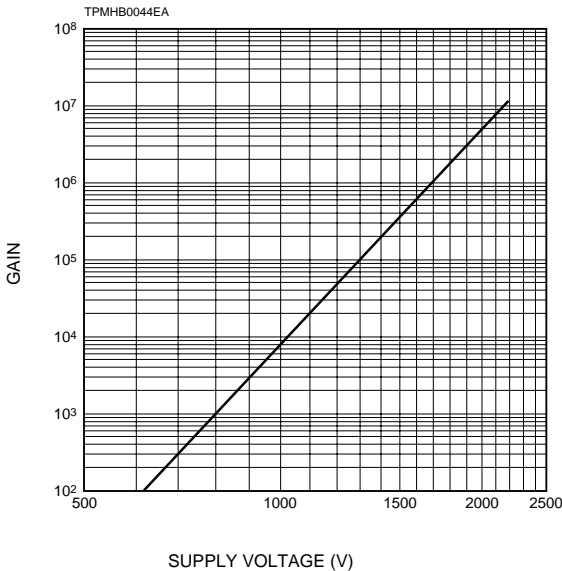

Figure 4: Typical Time Response

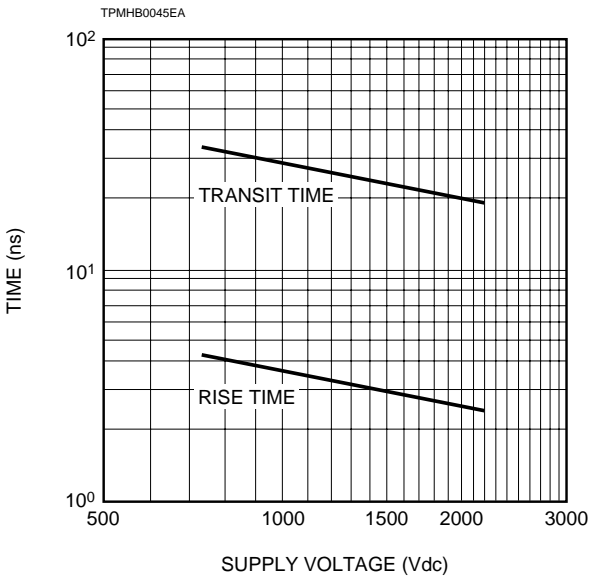

Figure 5: Typical Temperature Coefficient of Quantum Efficiency

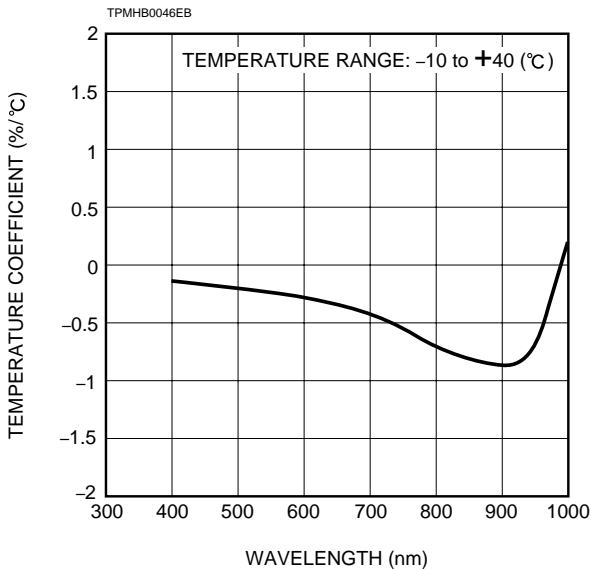
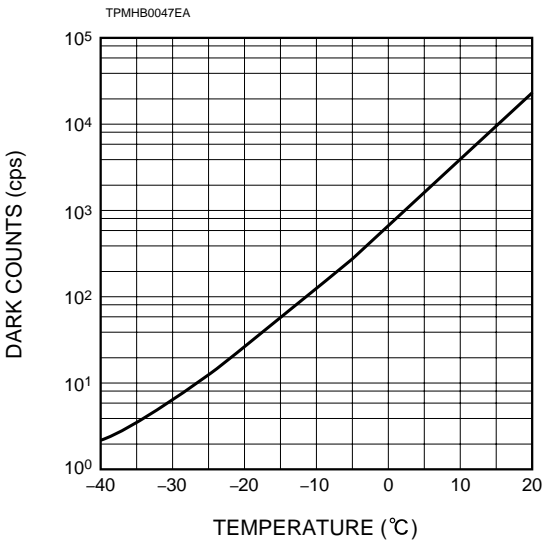

Figure 6: Typical Dark Counts vs. Temperature



COOLING

As Figure 6 shows, the dark counts of the R3310-02 and R4330-02 decreases by cooling the tube. Therefore, when performing photon counting, it is recommended that the tube be cooled down to about -20°C. The cooler C2761 which features temperature control from -30°C to 0°C is available from HAMAMATSU.

PHOTOMULTIPLIER TUBES R3310-02, R4330-02

Figure 7: Dimensional Outline and Basing Diagram (Unit : mm)

a) TUBE

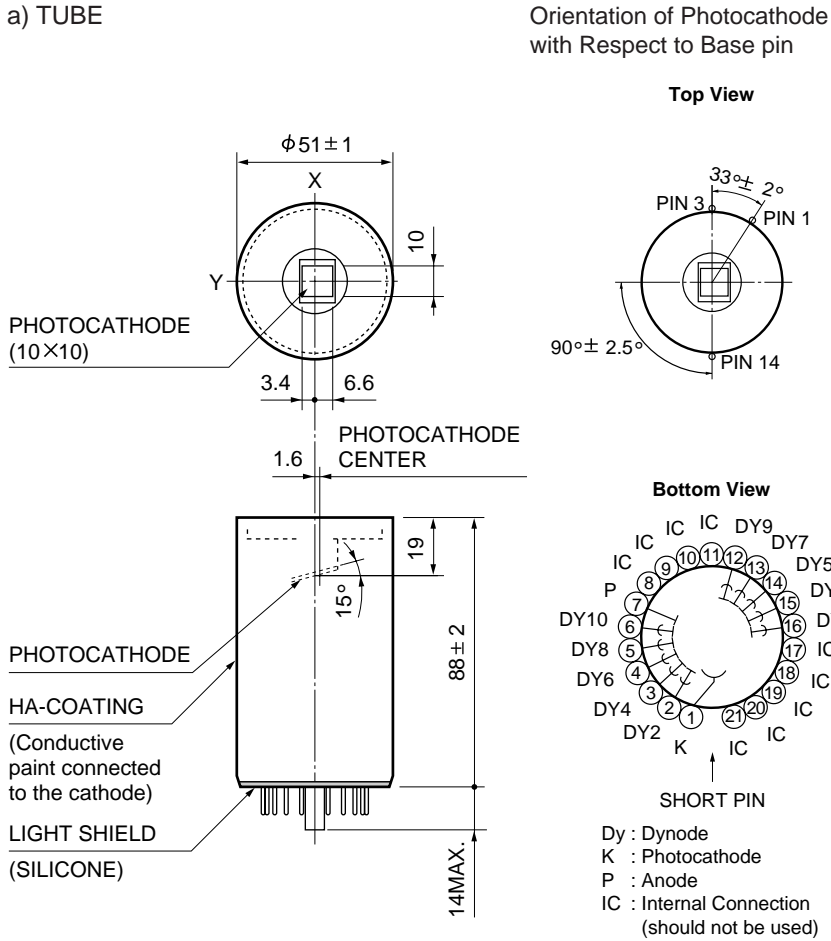

b) PHOTOCATHODE

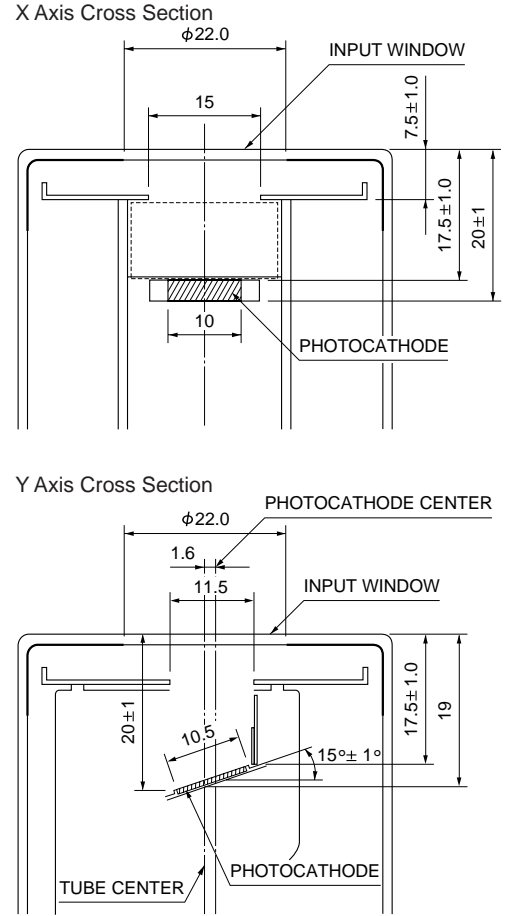

c) SOCKET(Refer to NOTES®)

E678-21C (SUPPLIED)

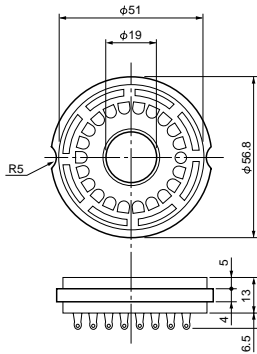

E678-21D (OPTION)

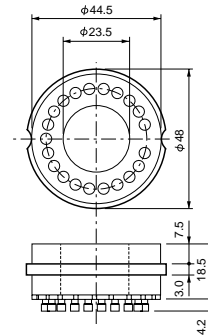

REMARKS

- HA coating
The R3310-02 and R4330-02 are coated with the conductive paint connected to the cathode, which is covered with an insulating material (HA coating). This method decreases noise. Care should be taken not to damage the insulating cover wrapping around the bulb.

CAUTIONS

- Use the HAMAMATSU SOCKET E678-21C or E678-21D.
- When soldering the voltage dividers to the socket, the PMT should be inserted in the socket.

HAMAMATSU

HAMAMATSU PHOTONICS K.K., Electron Tube Center

314-5, Shimokanzo, Toyooka-village, Iwata-gun, Shizuoka-ken, 438-0193, Japan, Telephone: (81)539/62-5248, Fax: (81)539/62-2205

U.S.A.: Hamamatsu Corporation: 360 Foothill Road, Bridgewater, N.J. 08807-0910, U.S.A., Telephone: (1)908-231-0960, Fax: (1)908-231-1218

Germany: Hamamatsu Photonics Deutschland GmbH: Arzbergerstr. 10, D-82211 Herrsching am Ammersee, Germany, Telephone: (49)8152-375-0, Fax: (49)8152-2658

France: Hamamatsu Photonics France S.A.R.L.: 8, Rue du Saule Trapu, Parc du Moulin de Massy, 91882 Massy Cedex, France, Telephone: (33)1 69 53 71 00, Fax: (33)1 69 53 71 10

United Kingdom: Hamamatsu Photonics UK Limited: Lough Point, 2 Gladbeck Way, Windmill Hill, Enfield, Middlesex EN2 7JA, United Kingdom, Telephone: (44)181-367-3560, Fax: (44)181-367-6384

North Europe: Hamamatsu Photonics Norden AB: Färögatan 7, S-164-40 Kista Sweden, Telephone: (46)8-703-29-50, Fax: (46)8-750-58-95

Italy: Hamamatsu Photonics Italia: S.R.L.: Via Della Moia, 1/E, 20020 Arese, (Milano), Italy, Telephone: (39)2-935 81 733, Fax: (39)2-935 81 741

TPMH1021E04
SEP. 1997