LOW VOLTAGE DETECTOR WITH OUTPUT DELAY

NO.EA-098-061102

OUTLINE

The R3115Z Series are CMOS-based voltage detector ICs with high detector threshold accuracy and ultra-low supply current, which can be operated at an extremely low voltage and is used for system reset as an example.

Each of these ICs consists of a voltage reference unit, a comparator, resistor net for detector threshold setting, an output driver, a hysteresis circuit, and an output delay circuit. The detector threshold is fixed with high accuracy internally and does not require any adjustment. Two output types, Nch open drain type and CMOS type are available.

Since the package is WLCSP-4-P2, high density mounting on boards is possible.

FEATURES

- Built-in Output Delay Circuit..... Typ. 100ms with an external capacitor: 0.022 μ F
- Supply Current Typ. 0.8 μ A ($V_{DD}=3.5V$)
- Operating Voltage Range..... 0.7 to 6.0V ($T_{opt}=25^{\circ}C$)
- Detector Threshold..... 0.9V to 5.0V
- Accuracy Detector Threshold $\pm 2.0\%$
- Temperature-Drift Coefficient of Detector Threshold Typ. $\pm 100ppm/^{\circ}C$
- Two Output Types Nch Open Drain and CMOS
- Package WLCSP-4-P2

APPLICATIONS

- Micro controller and Logic Circuit Reset
- Battery Checker
- Window Comparator
- Wave Shaping Circuit
- Battery Back-up Circuit
- Power Failure Detector

BLOCK DIAGRAMS

Nch Open Drain Output (R3115Zxx1A)

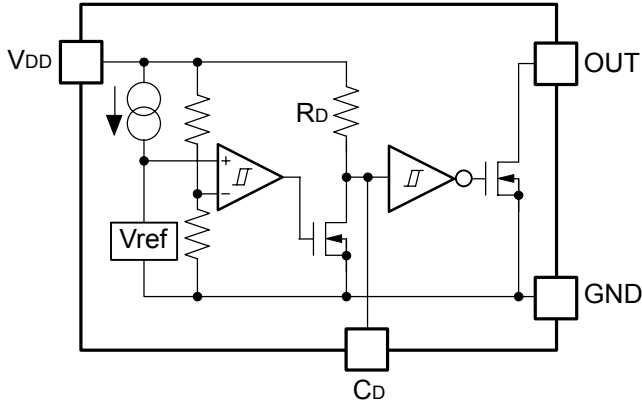

CMOS Output (R3115Zxx1C)

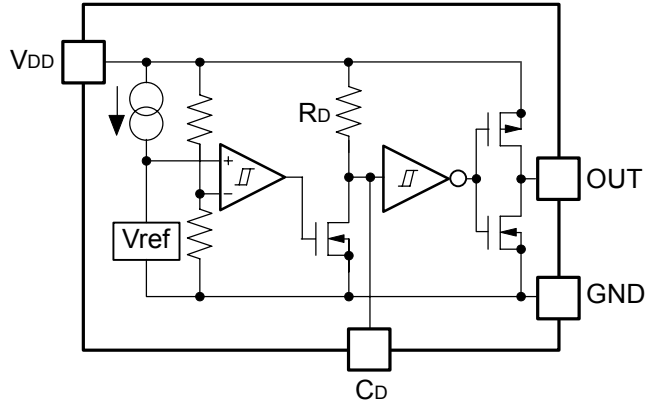

SELECTION GUIDE

The detector threshold, the output type, and the taping type of R3115Z Series can be designated at the users' request by specifying the part number as follows;

R3115Zxx1x-xx-x ← Part Number
 ↑ ↑ ↑ ↑ ↑
 a b c d e

Code	Contents
a	Designation of Package Type; Z: WLCSP-4-P2
b	Setting Detector Threshold ($-V_{DET}$); Stepwise setting with a step of 0.1V in the range of 0.9V to 5.0V is possible.
c	Designation of Output Type; A: Nch Open Drain C: CMOS
d	Designation of Taping Type; TR is prescribed as standard directions. (Refer to Taping Specifications)
e	Designation of Composition of pin plating. -F: Lead free plating

PIN CONFIGURATIONS

WLCSP-4-P2



PIN DESCRIPTIONS

Pin No.	Symbol	Description
1	GND	Ground Pin
2	C _D	Pin for External Capacitor (for setting output delay)
3	OUT	Output Pin (Output "L" at detector threshold, Output "H" at released voltage)
4	V _{DD}	Supply Voltage Pin

ABSOLUTE MAXIMUM RATINGS

Symbol	Item	Rating	Unit
V _{DD}	Supply Voltage	6.5	V
V _{OUT1}	Output Voltage (CMOS)	V _{SS} -0.3 to V _{DD} +0.3	V
V _{OUT2}	Output Voltage (Nch)	V _{SS} -0.3 to 6.5	V
I _{OUT}	Output Current	20	mA
P _D	Power Dissipation(WLCSP-4-P2)* ¹	530	mW
T _{opt}	Operating Temperature Range	-40 to 85	°C
T _{stg}	Storage Temperature Range	-55 to 125	°C

1) For Power Dissipation, please refer to PACKAGE INFORMATION to be described.

ABSOLUTE MAXIMUM RATINGS

Absolute Maximum ratings are threshold limit values that must not be exceeded ever for an instant under any conditions. Moreover, such values for any two items must not be reached simultaneously. Operation above these absolute maximum ratings may cause degradation or permanent damage to the device. These are stress ratings only and do not necessarily imply functional operation below these limits.

ELECTRICAL CHARACTERISTICS

● R3115Z091A/C

T_{opt}=25°C

Symbol	Item	Conditions	Min.	Typ.	Max.	Unit	
-V _{DET}	Detector Threshold		0.882	0.900	0.918	V	
V _{HYS}	Detector Threshold Hysteresis		0.027	0.045	0.063	V	
I _{SS}	Supply Current	V _{DD} =0.8V		0.6	2.0	μA	
		V _{DD} =1.9V		0.5	2.0		
V _{DDH}	Maximum Operating Voltage				6.0	V	
V _{DDL}	Minimum Operating Voltage* ^{Note1}	T _{opt} =25°C			0.7	V	
		-40°C ≤ T _{opt} ≤ 85°C			0.8		
I _{OUT}	Output Current (Driver Output Pin)	Nch	V _{DS} =0.05V, V _{DD} =0.70V	10	120		μA
			V _{DS} =0.50V, V _{DD} =0.85V	0.05	0.90		mA
		Pch	V _{DS} =-2.1V, V _{DD} =4.5V	1.0	3.5		mA
V _{TCD}	C _D pin Threshold Voltage	V _{DD} =0.99V	0.396	0.495	0.594	V	
I _{CD}	C _D pin Output Current	V _{DS} =0.10V, V _{DD} =0.70V	2	70		μA	
		V _{DS} =0.50V, V _{DD} =0.85V	10	400			
R _D	Output Delay Resistance		3.25	6.50	13.00	MΩ	
Δ-V _{DET} / ΔT _{opt}	Detector Threshold Temperature Coefficient	-40°C ≤ T _{opt} ≤ 85°C		±100		ppm/ °C	

*Note 1: Minimum Operating Voltage means the value of input voltage when output voltage maintains 0.1V or less. (In the case of Nch Open Drain Type, Output pin is pulled up with a resistance of 470kΩ to 5.0V.)

● R3115Z271A/C

T_{opt}=25°C

Symbol	Item	Conditions	Min.	Typ.	Max.	Unit	
-V _{DET}	Detector Threshold		2.646	2.700	2.754	V	
V _{HYS}	Detector Threshold Hysteresis		0.081	0.135	0.189	V	
I _{SS}	Supply Current	V _{DD} =2.6V		1.0	3.0	μA	
		V _{DD} =3.7V		0.5	2.5		
V _{DDH}	Maximum Operating Voltage				6.0	V	
V _{DDL}	Minimum Operating Voltage* ^{Note1}	T _{opt} =25°C			0.7	V	
		-40°C ≤ T _{opt} ≤ 85°C			0.8		
I _{OUT}	Output Current (Driver Output Pin)	Nch	V _{DS} =0.05V, V _{DD} =0.70V	10	120		μA
			V _{DS} =0.50V, V _{DD} =1.50V	1.0	3.0		mA
		Pch	V _{DS} =-2.1V, V _{DD} =4.5V	1.0	3.5		mA
V _{TCD}	C _D pin Threshold Voltage	V _{DD} =2.97V	1.188	1.485	1.782	V	
I _{CD}	C _D pin Output Current	V _{DS} =0.1V, V _{DD} =0.7V	2.0	70.0		μA	
		V _{DS} =0.5V, V _{DD} =1.5V	200	500			
R _D	Output Delay Resistance		3.25	6.50	13.00	MΩ	
Δ-V _{DET} / ΔT _{opt}	Detector Threshold Temperature Coefficient	-40°C ≤ T _{opt} ≤ 85°C		±100		ppm/ °C	

*Note 1: Minimum Operating Voltage means the value of input voltage when output voltage maintains 0.1V or less. (In the case of Nch Open Drain Type, Output pin is pulled up with a resistance of 470kΩ to 5.0V.)

● R3115Z501A/C

T_{opt}=25°C

Symbol	Item	Conditions	Min.	Typ.	Max.	Unit	
-V _{DET}	Detector Threshold		4.900	5.000	5.100	V	
V _{HYS}	Detector Threshold Hysteresis		0.150	0.250	0.350	V	
I _{SS}	Supply Current	V _{DD} =4.9V		1.5	3.0	μA	
		V _{DD} =6.0V		0.6	2.5		
V _{DDH}	Maximum Operating Voltage				6.0	V	
V _{DDL}	Minimum Operating Voltage* ^{Note1}	T _{opt} =25°C			0.7	V	
		-40°C ≤ T _{opt} ≤ 85°C			0.8		
I _{OUT}	Output Current (Driver Output Pin)	Nch	V _{DS} =0.05V, V _{DD} =0.70V	10	120		μA
			V _{DS} =0.50V, V _{DD} =1.50V	1.0	3.0		mA
		Pch	V _{DS} =-2.1V, V _{DD} =6.0V	1.5	4.5		mA
V _{TCD}	C _D pin Threshold Voltage	V _{DD} =5.50V	2.200	2.750	3.300	V	
I _{CD}	C _D pin Output Current	V _{DS} =0.1V, V _{DD} =0.7V	2.0	70.0		μA	
		V _{DS} =0.5V, V _{DD} =1.5V	200	500			
R _D	Output Delay Resistance		3.25	6.50	13.00	MΩ	
$\frac{\Delta -V_{DET}}{\Delta T_{opt}}$	Detector Threshold Temperature Coefficient	-40°C ≤ T _{opt} ≤ 85°C		±100		ppm/ °C	

*Note 1: Minimum Operating Voltage means the value of input voltage when output voltage maintains 0.1V or less. (In the case of Nch Open Drain Type, Output pin is pulled up with a resistance of 470kΩ to 5.0V.)

ELECTRICAL CHARACTERISTICS BY DETECTOR THRESHOLD

Product Code	Detector Threshold			Hysteresis Range			Supply Current 1			Supply Current 2			Output Current 1			Output Current 2		
	-V _{DET} [V]			V _{HYS} [V]			I _{SS1} [μ A]			I _{SS2} [μ A]			I _{OUT1} [mA]			I _{OUT2} [mA]		
	Min.	Typ.	Max.	Min.	Typ.	Max.	Condition	Typ.	Min.	Condition	Typ.	Max.	Condition	Min.	Typ.	Conditions	Min.	Typ.
R3115Z091A/C	0.882	0.900	0.918	0.027	0.045	0.063	V _{DD} = -V _{DET} -0.1V	0.6	2.0	V _{DD} = -V _{DET} +0.1V	0.5	2.0	0.01	0.12	Nch	V _{DS} = 0.5V V _{DD} = 0.85V	0.05	0.9
R3115Z101A/C	0.980	1.000	1.020	0.030	0.050	0.070		0.7	2.5								0.2	1.8
R3115Z111A/C	1.078	1.100	1.122	0.033	0.055	0.077												
R3115Z121A/C	1.176	1.200	1.224	0.036	0.060	0.084		1.0	3.0								0.5	2.5
R3115Z131A/C	1.274	1.300	1.326	0.039	0.065	0.091												
R3115Z141A/C	1.372	1.400	1.428	0.042	0.070	0.098												
R3115Z151A/C	1.470	1.500	1.530	0.045	0.075	0.105												
R3115Z161A/C	1.568	1.600	1.632	0.048	0.080	0.112												
R3115Z171A/C	1.666	1.700	1.734	0.051	0.085	0.119												
R3115Z181A/C	1.764	1.800	1.836	0.054	0.090	0.126												
R3115Z191A/C	1.862	1.900	1.938	0.057	0.095	0.133												
R3115Z201A/C	1.960	2.000	2.040	0.060	0.100	0.140												
R3115Z211A/C	2.058	2.100	2.142	0.063	0.105	0.147												
R3115Z221A/C	2.156	2.200	2.244	0.066	0.110	0.154												
R3115Z231A/C	2.254	2.300	2.346	0.069	0.115	0.161												
R3115Z241A/C	2.352	2.400	2.448	0.072	0.120	0.168												
R3115Z251A/C	2.450	2.500	2.550	0.075	0.125	0.175												
R3115Z261A/C	2.548	2.600	2.652	0.078	0.130	0.182												
R3115Z271A/C	2.646	2.700	2.754	0.081	0.135	0.189												
R3115Z281A/C	2.744	2.800	2.856	0.084	0.140	0.196												
R3115Z291A/C	2.842	2.900	2.958	0.087	0.145	0.203												
R3115Z301A/C	2.940	3.000	3.060	0.090	0.150	0.210												
R3115Z311A/C	3.038	3.100	3.162	0.093	0.155	0.217												
R3115Z321A/C	3.136	3.200	3.264	0.096	0.160	0.224												
R3115Z331A/C	3.234	3.300	3.366	0.099	0.165	0.231												
R3115Z341A/C	3.332	3.400	3.468	0.102	0.170	0.238												
R3115Z351A/C	3.430	3.500	3.570	0.105	0.175	0.245												
R3115Z361A/C	3.528	3.600	3.672	0.108	0.180	0.252												
R3115Z371A/C	3.626	3.700	3.774	0.111	0.185	0.259												
R3115Z381A/C	3.724	3.800	3.876	0.114	0.190	0.266												
R3115Z391A/C	3.822	3.900	3.978	0.117	0.195	0.273												
R3115Z401A/C	3.920	4.000	4.080	0.120	0.200	0.280												
R3115Z411A/C	4.018	4.100	4.182	0.123	0.205	0.287												
R3115Z421A/C	4.116	4.200	4.284	0.126	0.210	0.294												
R3115Z431A/C	4.214	4.300	4.386	0.129	0.215	0.301												
R3115Z441A/C	4.312	4.400	4.488	0.132	0.220	0.308												
R3115Z451A/C	4.410	4.500	4.590	0.135	0.225	0.315												
R3115Z461A/C	4.508	4.600	4.692	0.138	0.230	0.322												
R3115Z471A/C	4.606	4.700	4.794	0.141	0.235	0.329												
R3115Z481A/C	4.704	4.800	4.896	0.144	0.240	0.336												
R3115Z491A/C	4.802	4.900	4.998	0.147	0.245	0.343												
R3115Z501A/C	4.900	5.000	5.100	0.150	0.250	0.350												

Output Current 3				Minimum Operating Voltage				C _D pin Threshold Voltage			C _D pin Output Current 1			C _D pin Output Current 2			Resistance for Output Delay			Detector Threshold Temperature Coefficient		
I _{OUT3} [mA]				V _{DDL} [V]				V _{TC_D} [V]			I _{CD1} [μA]			I _{CD2} [μA]			R _D [MΩ]			Δ-V _{DET} / ΔT _{opt} [ppm/°C]		
Condition	Min.	Typ.		Condition	Max.	Condition	Max.	Condition	Min.	Typ.	Max.	Condition	Min.	Typ.	Condition	Min.	Typ.	Min.	Typ.	Max.	Condition	Typ.
Pch	V _{DS} = -2.1V V _{DD} = 4.5V	1.5	3.5	T _{opt} = 25°C	0.7	-40°C ≧ T _{opt} ≦ 85°C	0.8	V _{DD} = (-V _{DET}) ×1.1V	0.396	0.495	0.594	V _{DS} = 0.1V V _{DD} = 0.7V	20	70	V _{DS} = 0.5V V _{DD} = 0.85V	0.01	400	3.25	6.5	13.0	-40°C ≧ T _{opt} ≦ 85°C	±100
									0.440	0.550	0.660											
									0.484	0.605	0.726											
									0.528	0.660	0.792											
									0.572	0.715	0.858											
									0.616	0.770	0.924											
									0.660	0.825	0.990											
									0.704	0.880	1.056											
									0.748	0.935	1.122											
									0.792	0.990	1.188											
									0.836	1.045	1.254											
									0.880	1.100	1.320											
									0.924	1.155	1.386											
									0.968	1.210	1.452											
									1.012	1.265	1.518											
	1.056	1.320	1.584																			
	1.100	1.375	1.650																			
	1.144	1.430	1.716																			
	1.188	1.485	1.782																			
	1.232	1.540	1.848																			
	1.276	1.595	1.914																			
	1.320	1.650	1.980																			
	1.364	1.705	2.046																			
	1.408	1.760	2.112																			
	1.452	1.815	2.178																			
	1.496	1.870	2.244																			
	1.540	1.925	2.310																			
	1.584	1.980	2.376																			
	1.628	2.035	2.442																			
	1.672	2.090	2.508																			
1.716	2.145	2.574																				
1.760	2.200	2.640																				
1.804	2.255	2.706																				
1.848	2.310	2.772																				
1.892	2.365	2.838																				
1.936	2.420	2.904																				
1.980	2.475	2.970																				
2.024	2.530	3.036																				
2.068	2.585	3.102																				
2.112	2.640	3.168																				
2.156	2.695	3.234																				
2.200	2.750	3.300																				
	V _{DS} = -2.1V V _{DD} = 6.0V	2.0	4.5																			

OPERATION

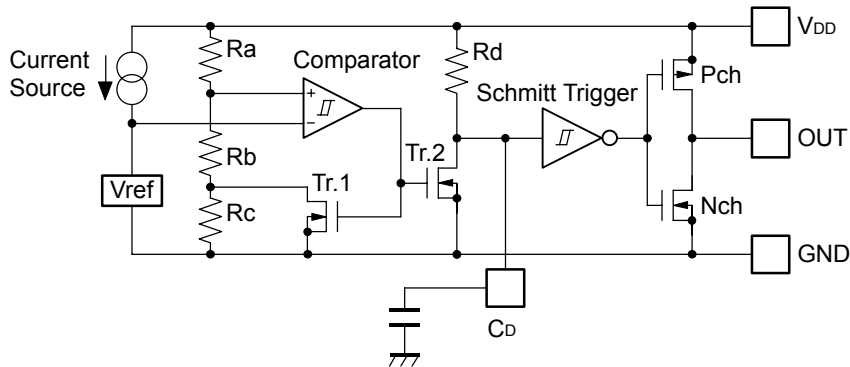

Fig. 1 Block Diagram with an external capacitor

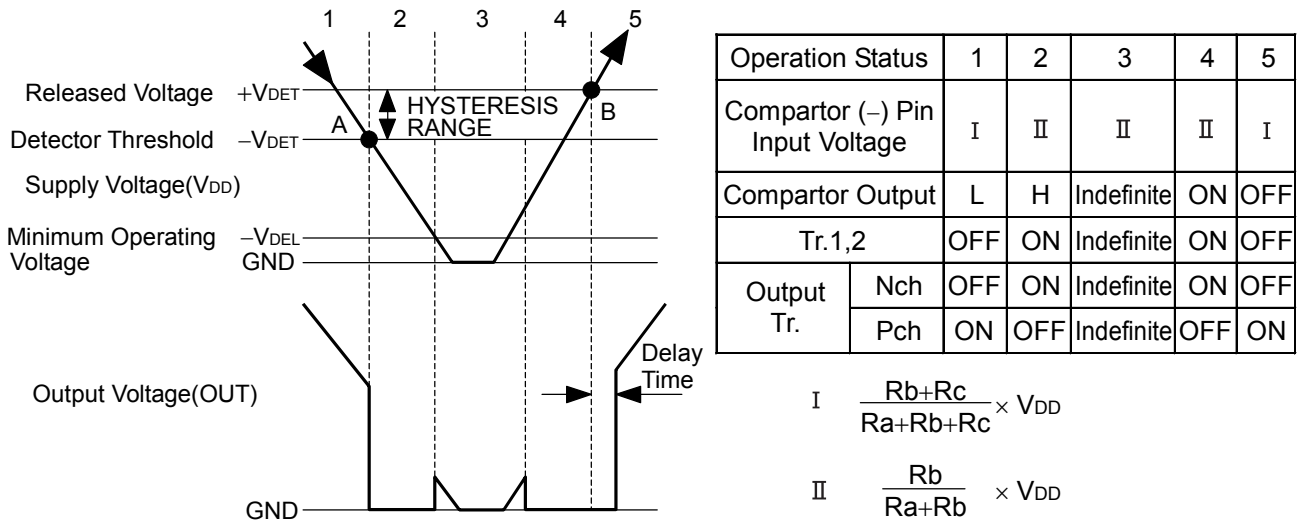
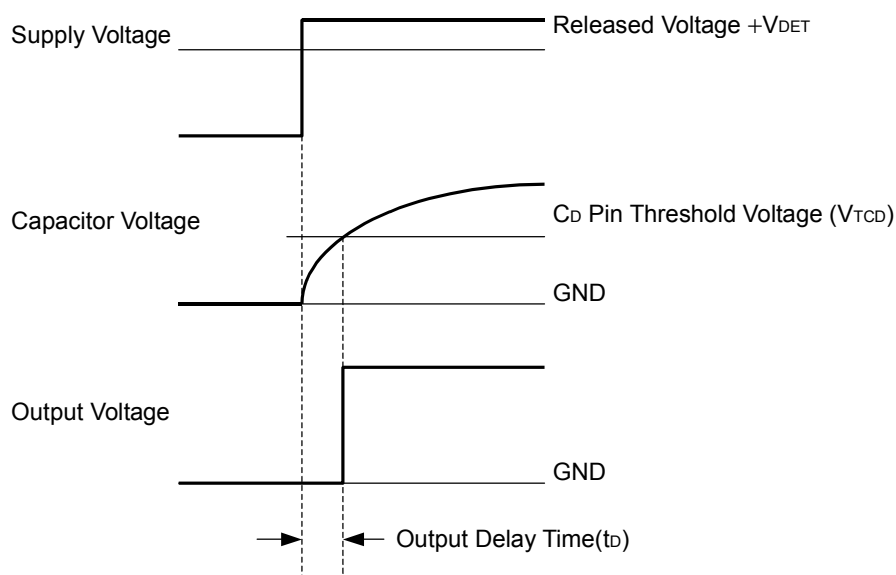

Fig. 2 Operation Diagram

1. Output voltage is equal to supply voltage. (As for Nch open drain type, equal to pull-up voltage.)
 2. When the supply voltage is down to the detector threshold voltage level(Point A), $V_{ref} \geq V_{DD} \times (Rb+Rc) / (Ra+Rb+Rc)$ is true, then output of the comparator is reversed from “L” to “H”, therefore output voltage becomes GND level.
 3. When the supply voltage is lower than minimum operating voltage, the operation of output transistor is indefinite. In the case of Nch open drain type, output voltage is equal to pull-up voltage.
 4. Output Voltage becomes GND level.
 5. When the supply voltage is higher than released voltage (Point B), $V_{ref} \leq V_{DD} \times Rb / (Ra+Rb)$ is true, then output of the comparator reaches the threshold level, and Output of Shmitt Trigger is reversed from “H” to “L”, then output voltage is equal to supply voltage. (As for Nch open drain type, equal to pull-up voltage.)
- *) The difference between released voltage and detector threshold voltage means hysteresis range voltage.

- **Operation of Output Delay**



When the supply voltage which is higher than released voltage is forced to V_{DD} pin, charge to an external capacitor starts, then capacitor voltage increases. Until the capacitor voltage reaches to C_D Pin threshold voltage, output voltage maintains "L". When the capacitor voltage becomes higher than C_D pin threshold voltage, output voltage is reversed from "L" to "H". Where, the time interval between the rising edge of supply voltage and output voltage reverse point means output delay time.

- **Output Delay Time**

Output Delay Time (t_D) can be calculated with the next formula.

$$t_D = 0.69 \times R_D \times C_D (\text{s})$$

R_D is internal resistor and set at $6.5\text{M}\Omega$ (Typ.) typically. C_D (F) describes the capacitance value of an external capacitor. Therefore,

$$t_D = 0.69 \times 6.5 \times 10^6 \times C_D (\text{s})$$

TEST CIRCUITS

*Pull-up circuit is not necessary for CMOS Output type, or R3115xxxxC.

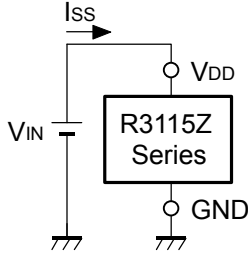

Supply Current Test Circuit

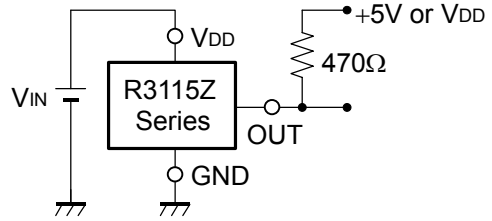

Detector Threshold Test Circuit

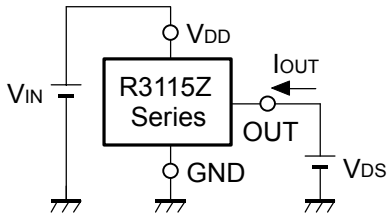

Nch Driver Output Current Test Circuit

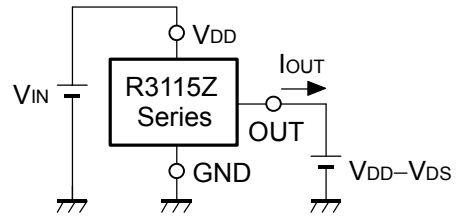

Pch Driver Output Current Test Circuit *Apply only to CMOS

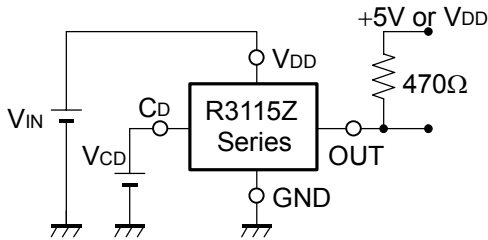

C_D Pin Threshold Test Circuit

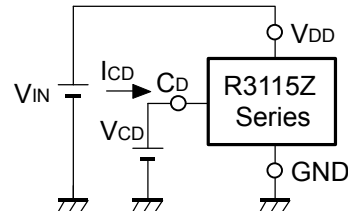

C_D Pin Output Current Test Circuit

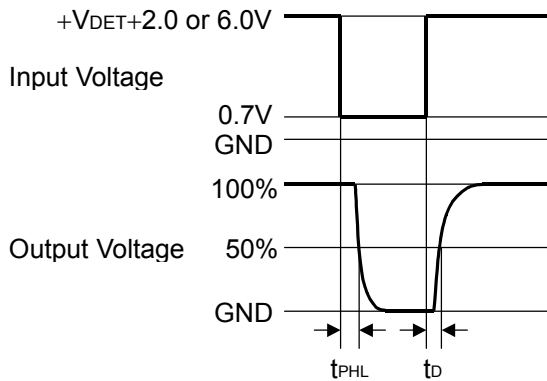

Output Delay Time Test Circuit

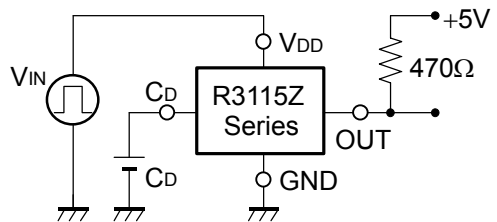

TYPICAL CHARACTERISTICS

1) Supply Current vs. Input Voltage

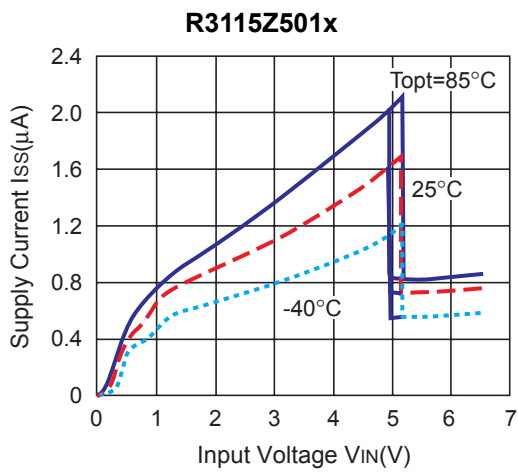
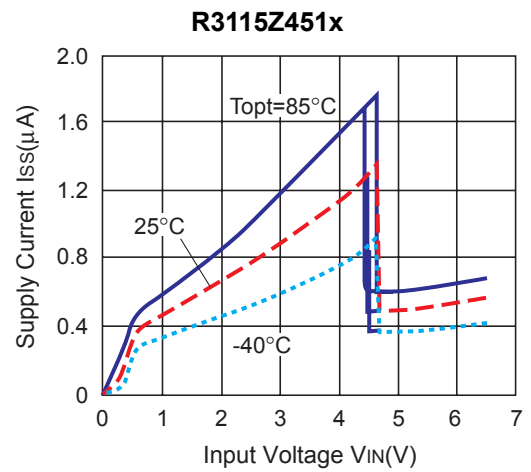
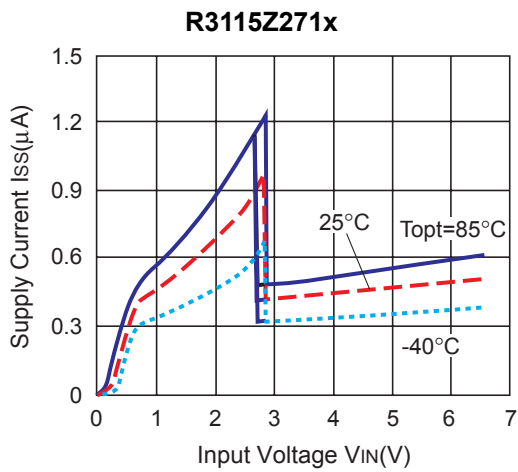
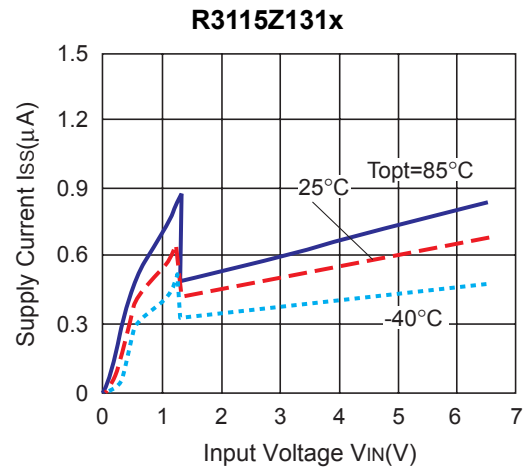
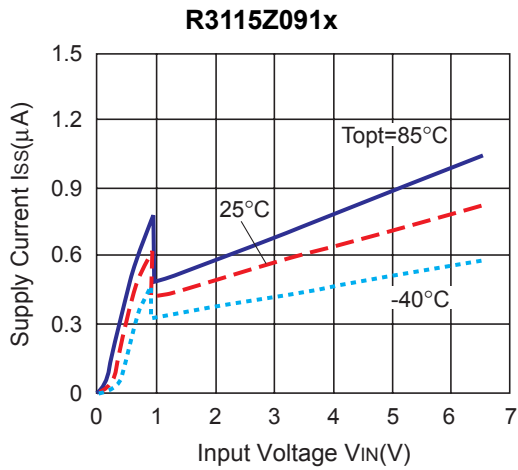

2) Detector Threshold vs. Temperature

R3115Z091x

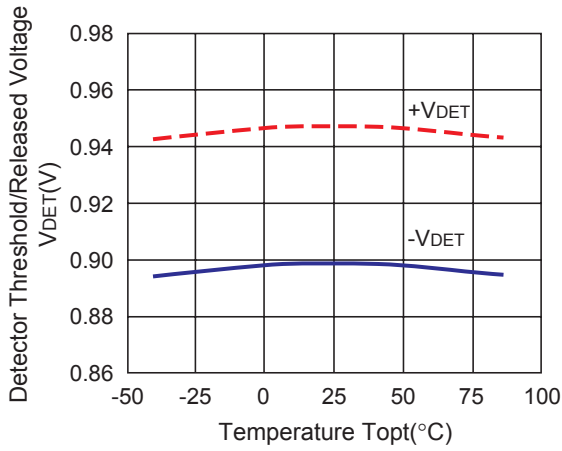

R3115Z131x

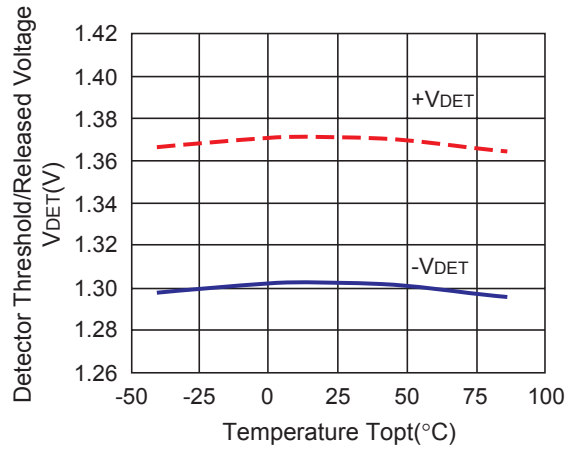

R3115Z271x

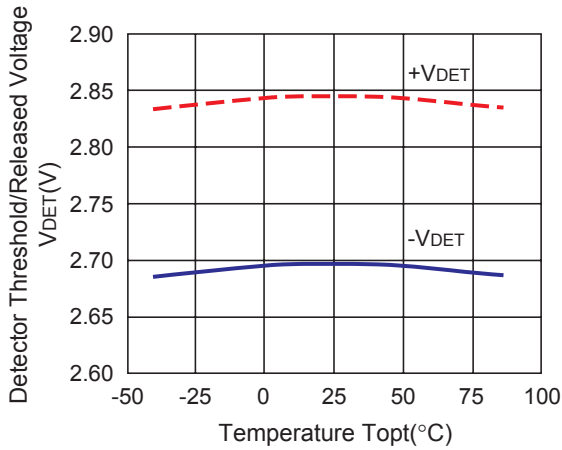

R3115Z451x

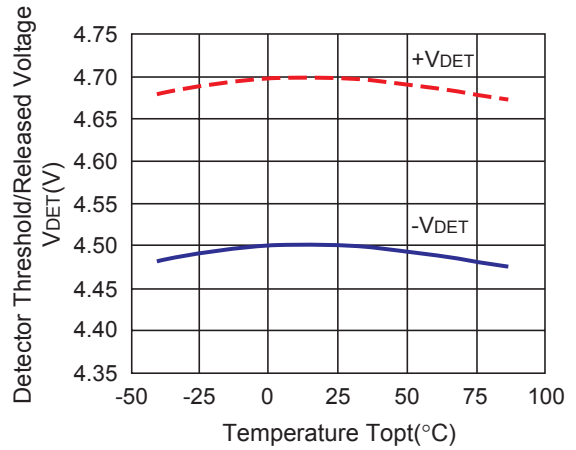

R3115Z501x

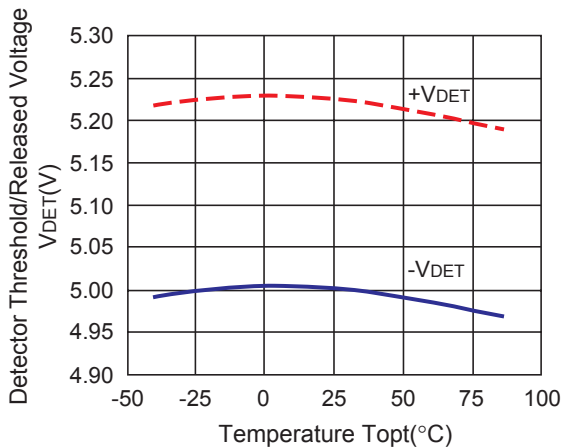

3) Output Voltage vs. Input Voltage

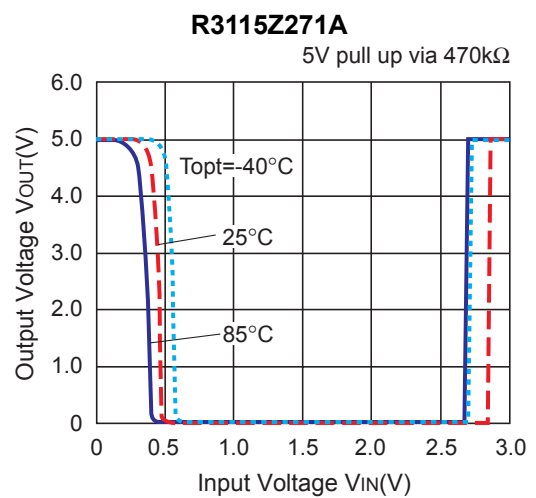
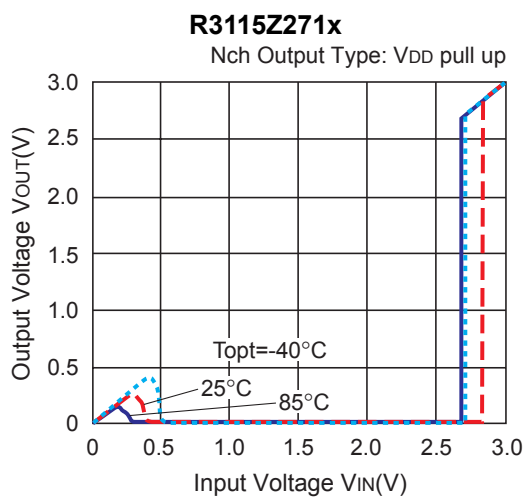
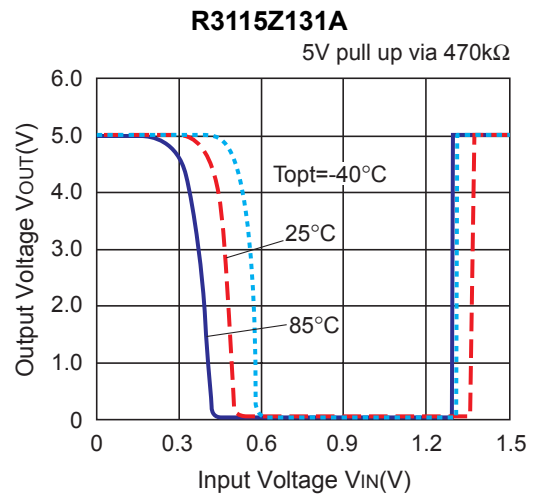
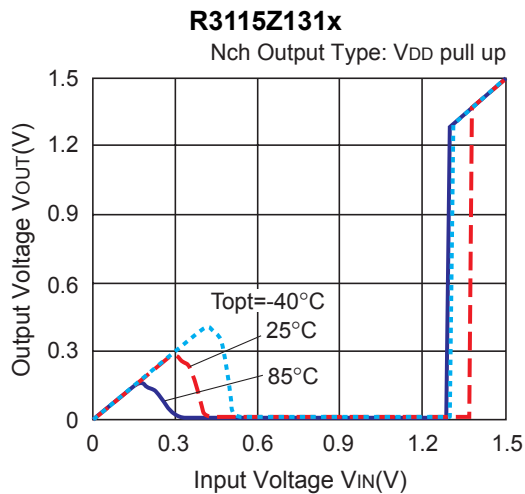
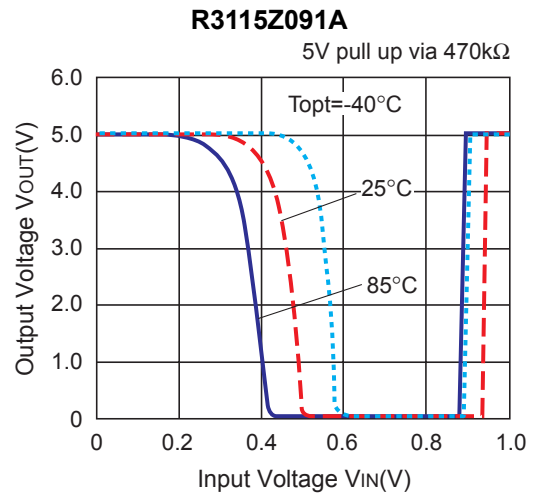
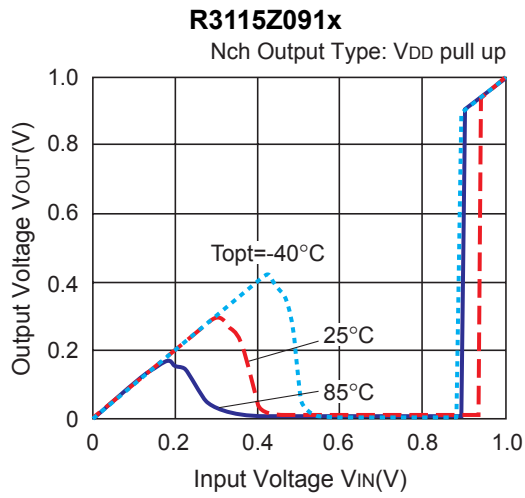

R3115Z451x

Nch Output Type: VDD pull up

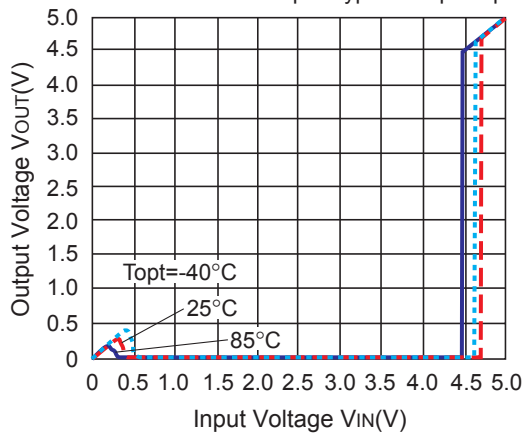

R3115Z451A

5V pull up via 470kΩ

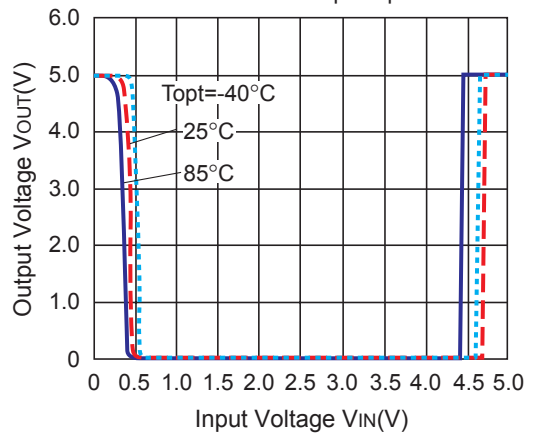

R3115Z501x

Nch Output Type: VDD pull up

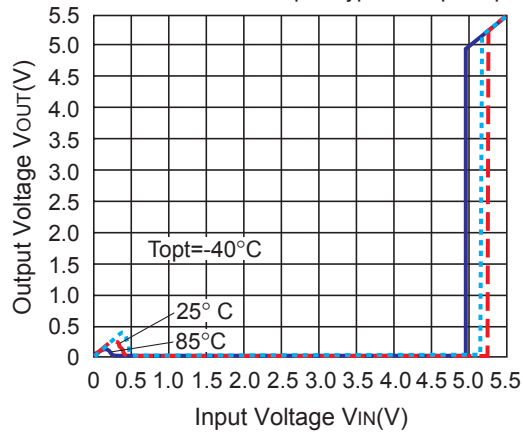

R3115Z501A

5V pull up via 470kΩ

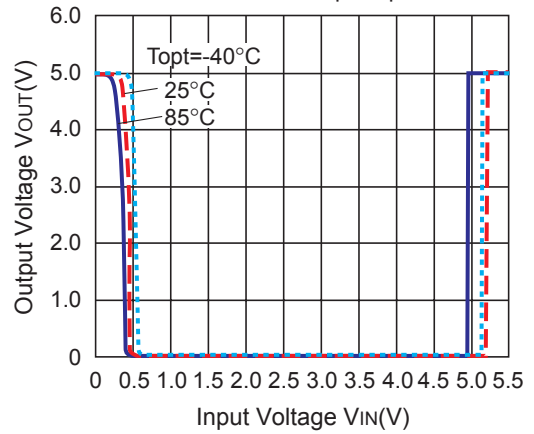

4) Nch Driver Output Current vs. V_{DS}

R3115Z091x

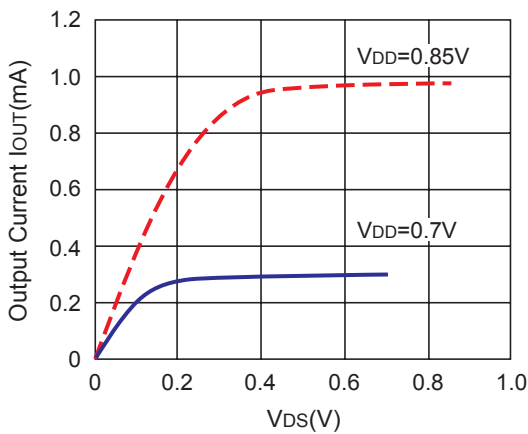

R3115Z131x

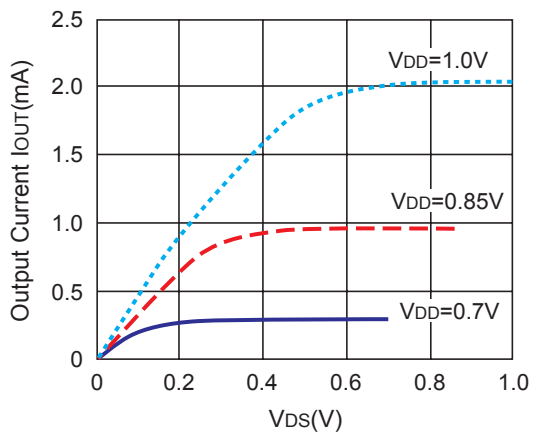

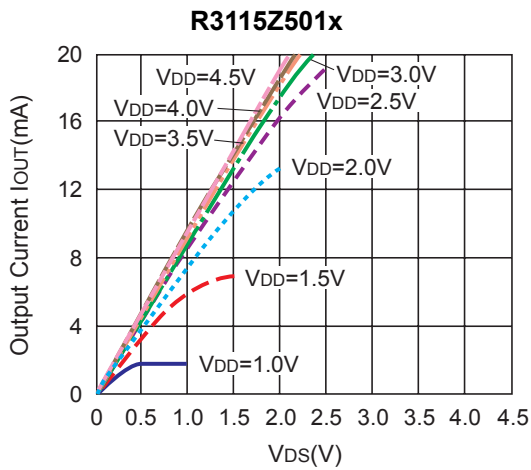
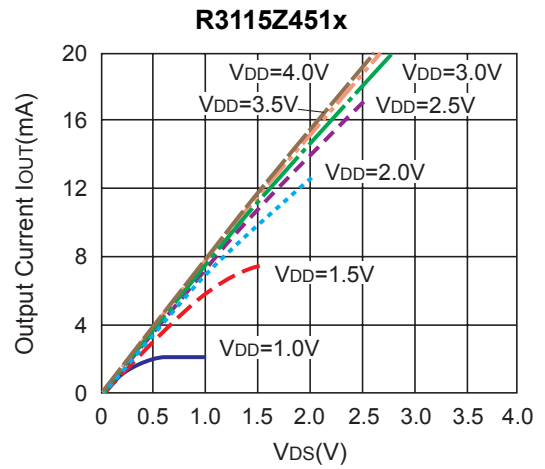
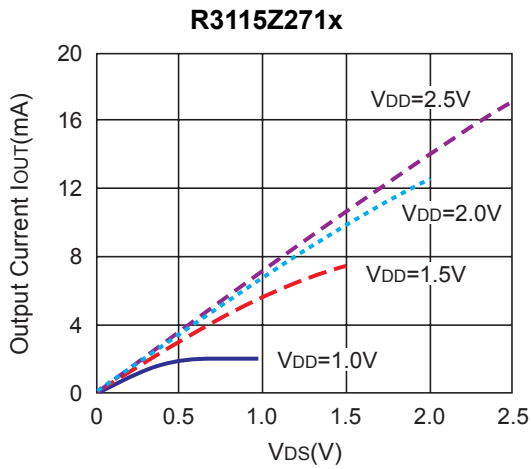

5) Nch Driver Output Current vs. Input Voltage

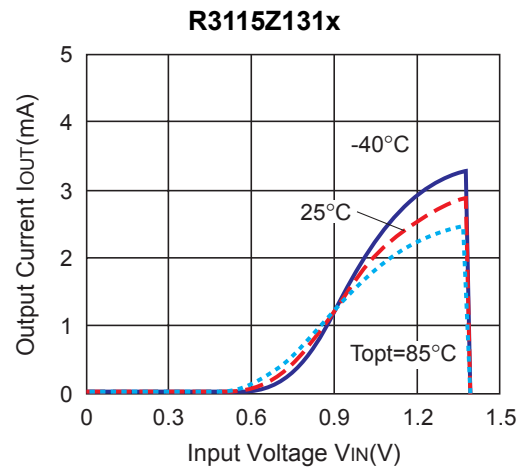
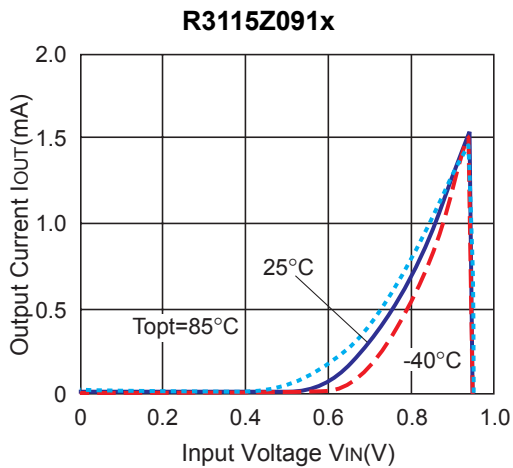

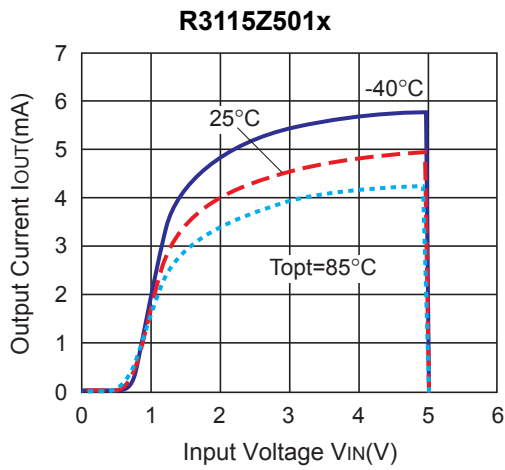
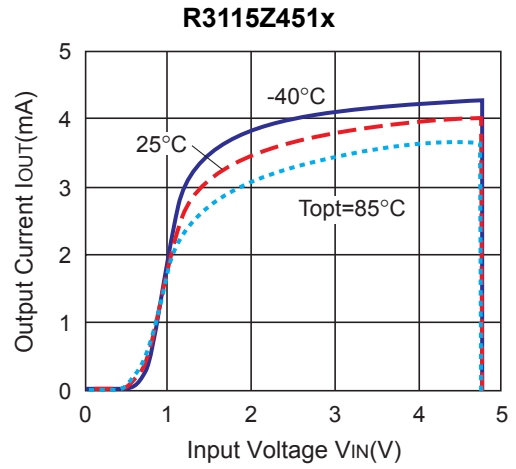
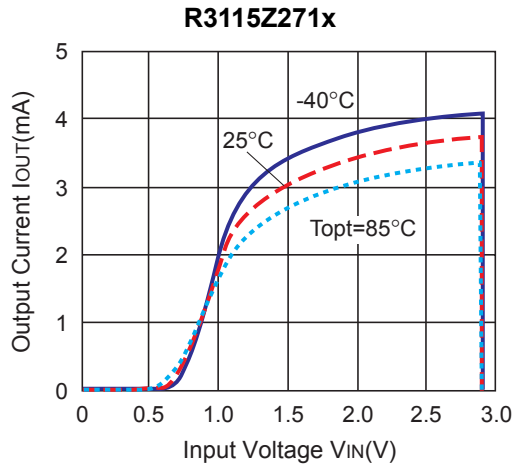

6) Pch Driver Output Current vs. Input Voltage

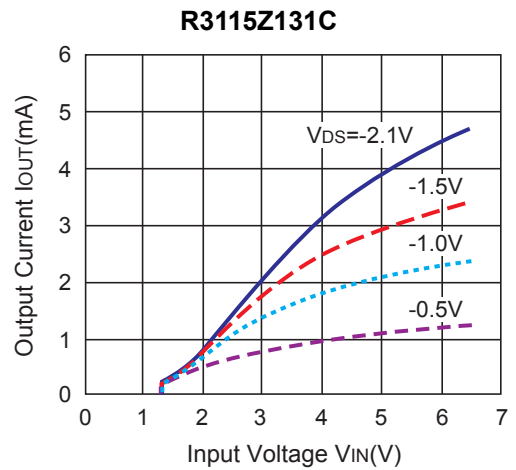
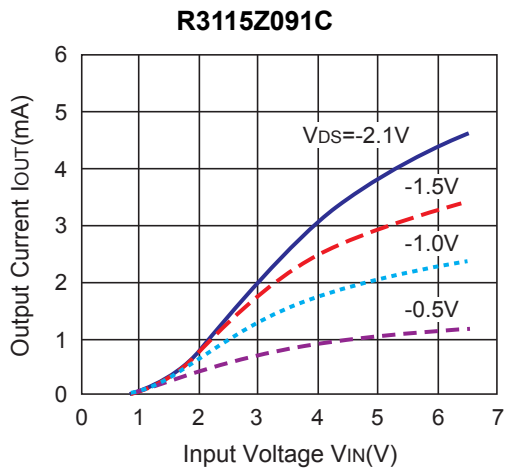

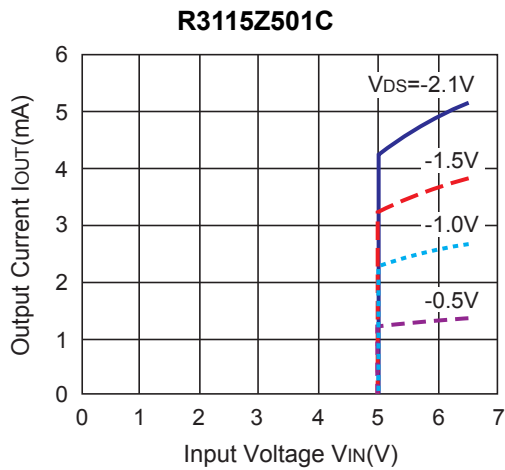
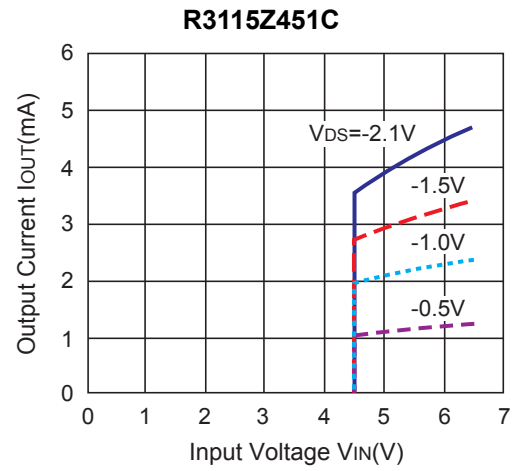
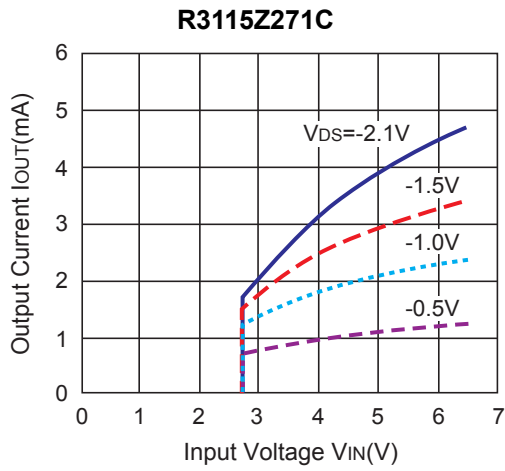

7) C_D Pin Threshold Voltage vs. Temperature

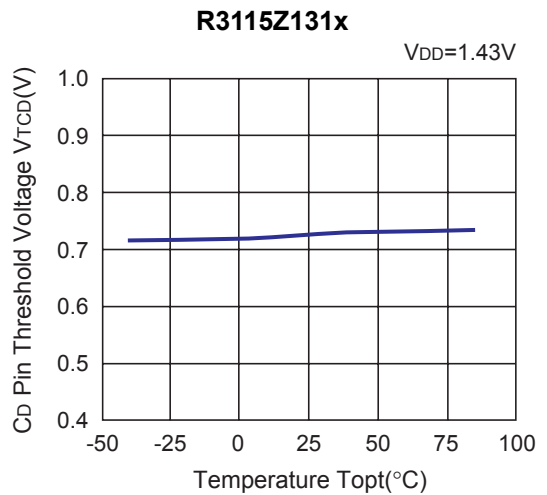
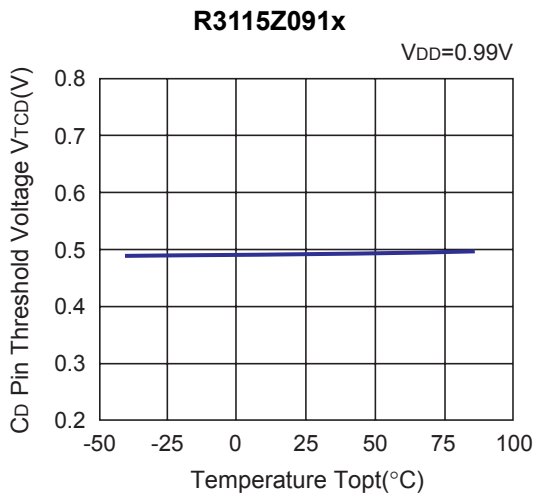

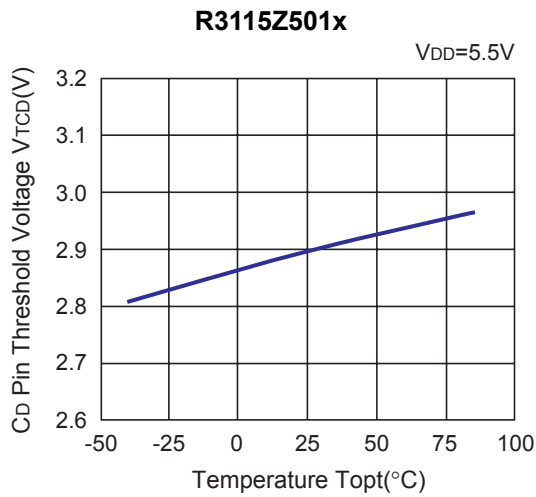
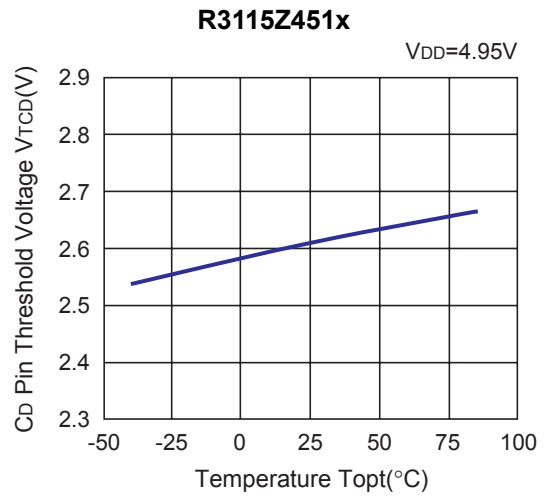
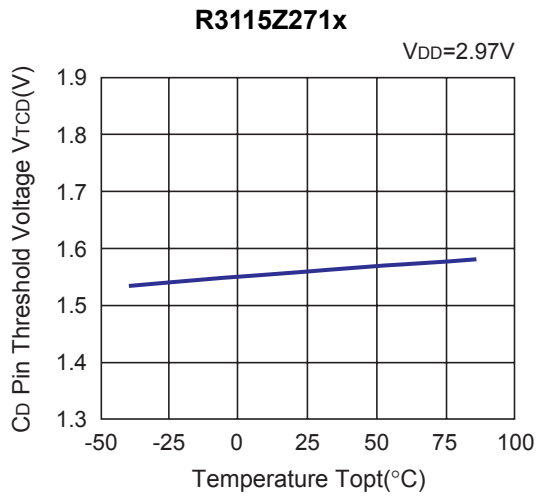

8) C_D Pin Output Current vs. Input Voltage

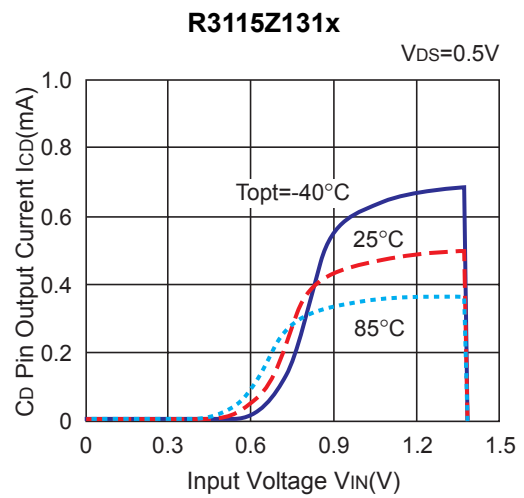
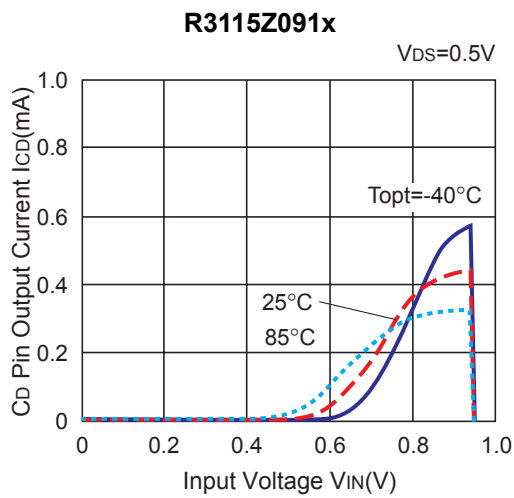

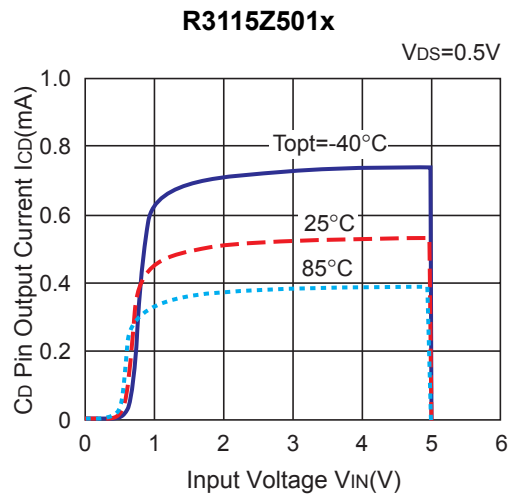
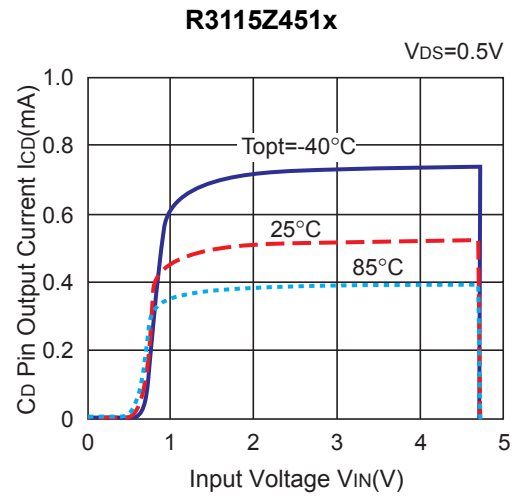
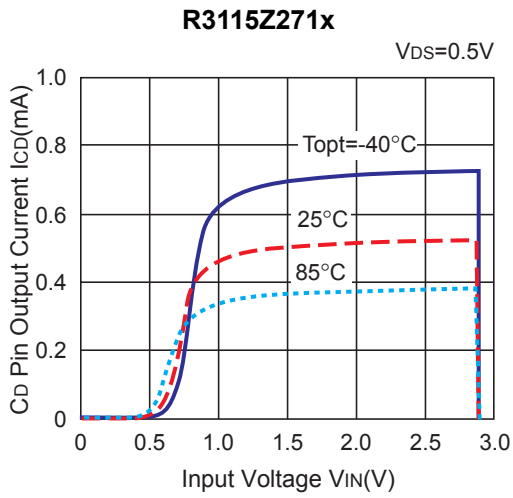

9) C_D Pin Output Current vs. V_{DS} (Topt=25°C)

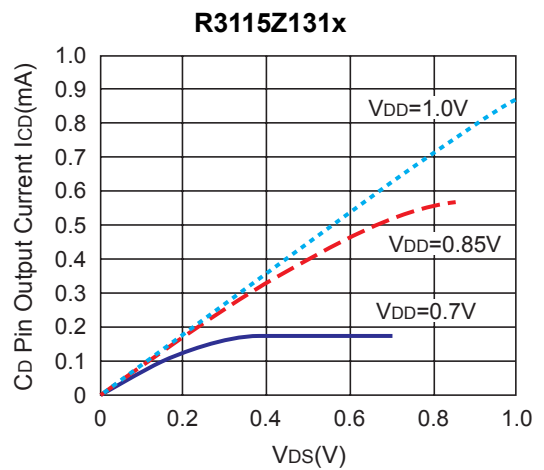
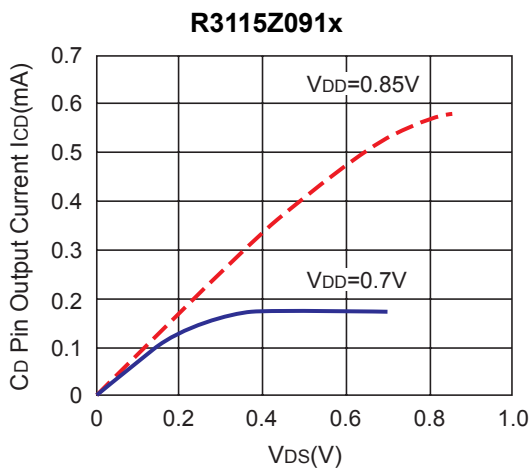

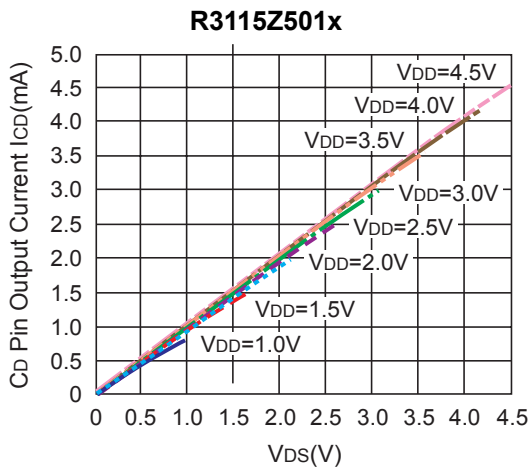
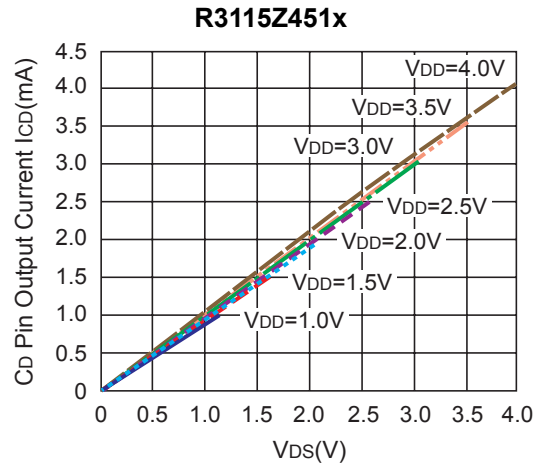
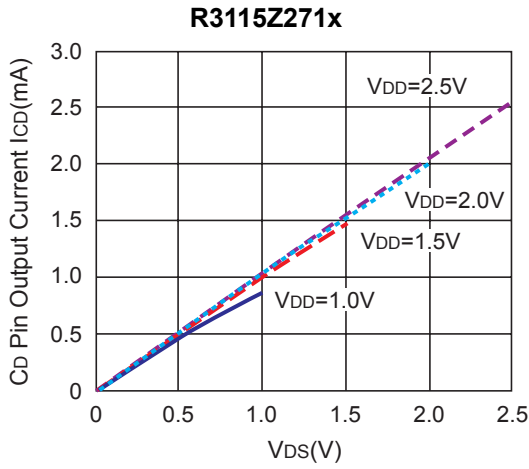

10) Output Delay Time vs. External Capacitance (T_{opt}=25°C)

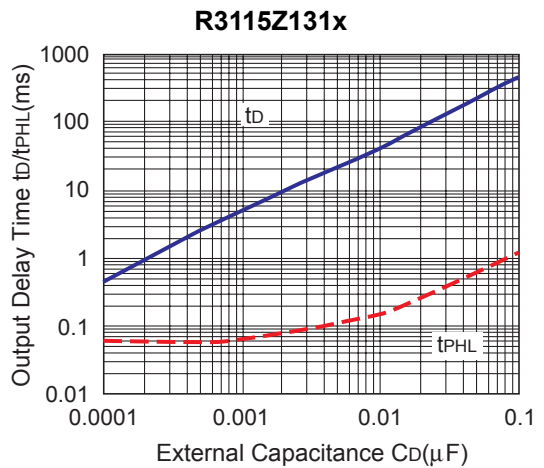
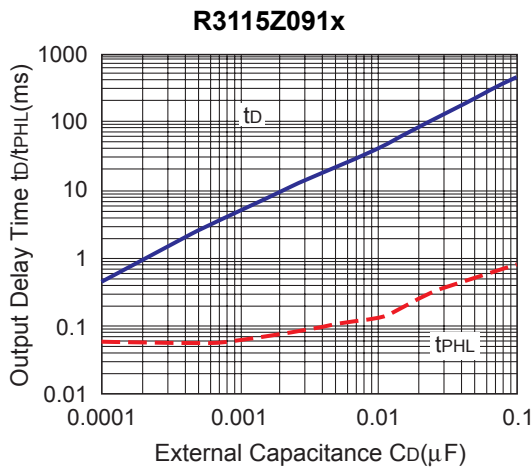

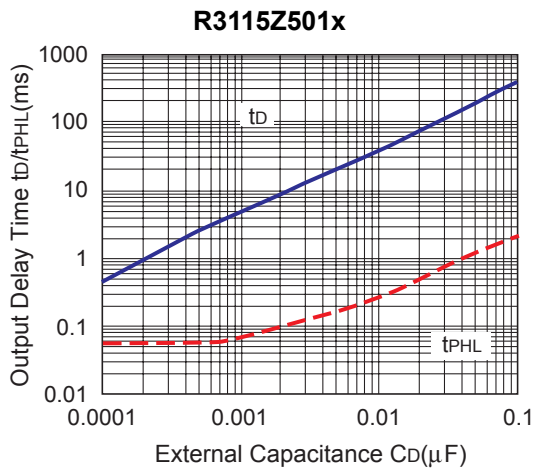
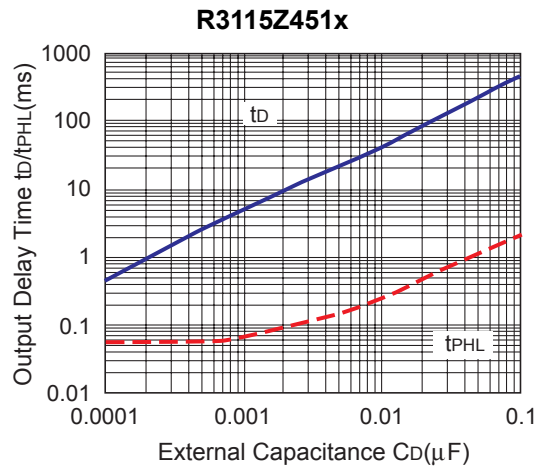
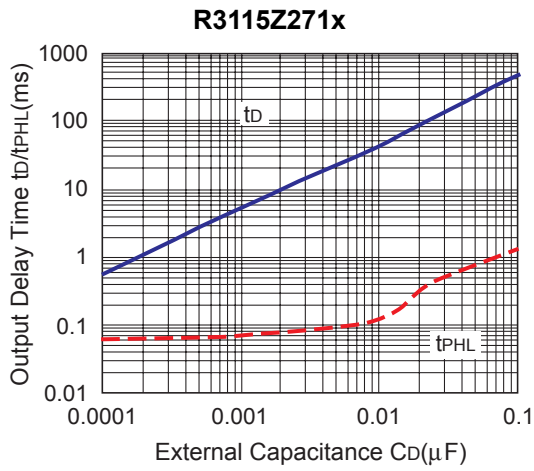

11) Delay Circuit Resistance vs. Temperature

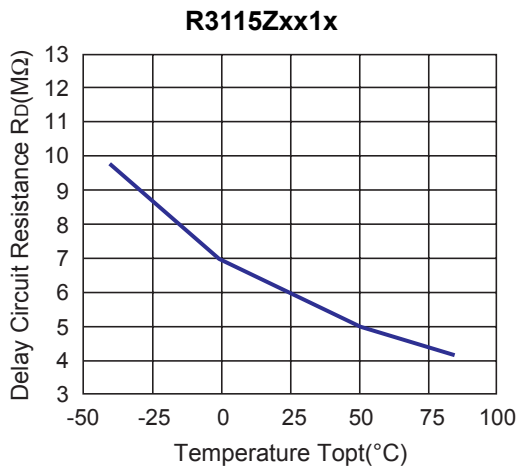

TYPICAL APPLICATION

- R3115Zxx1A CPU Reset Circuit (Nch Open Drain Output)**

Case 1. Input Voltage to R3115Zxx1A is equal to Input Voltage to CPU

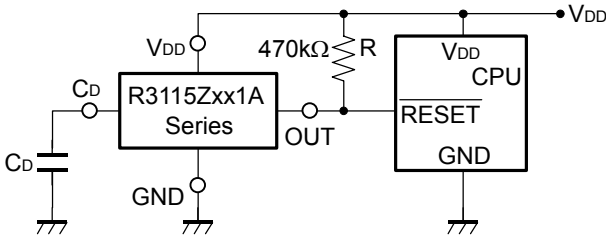

Case 2. Input Voltage to R3115Zxx1A is unequal to Input Voltage to CPU

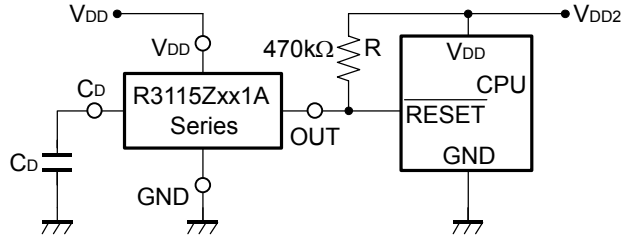

- R3115Zxx1C CPU Reset Circuit CMOS Output**

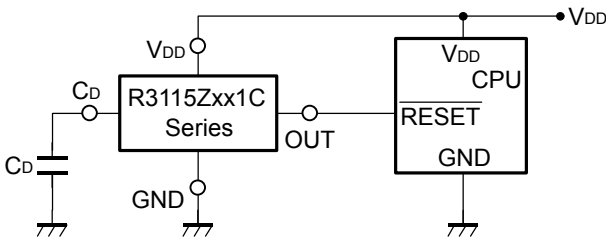

- R3115Zxx1A Output Delay Time Circuit 1 (Nch Open Drain Output)**

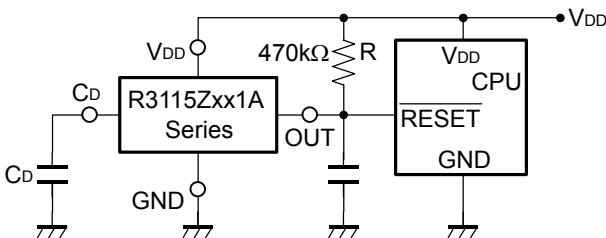

- R3115Zxx1A Output Delay Time Circuit 2 (Nch Open Drain Output)**

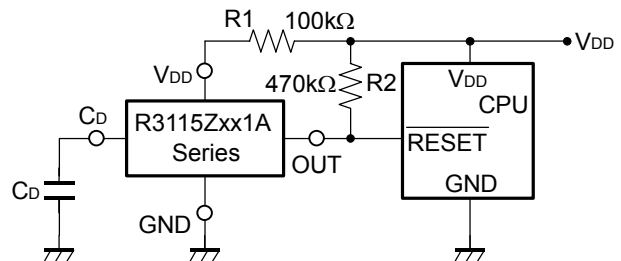

- Memory Back-up Circuit**

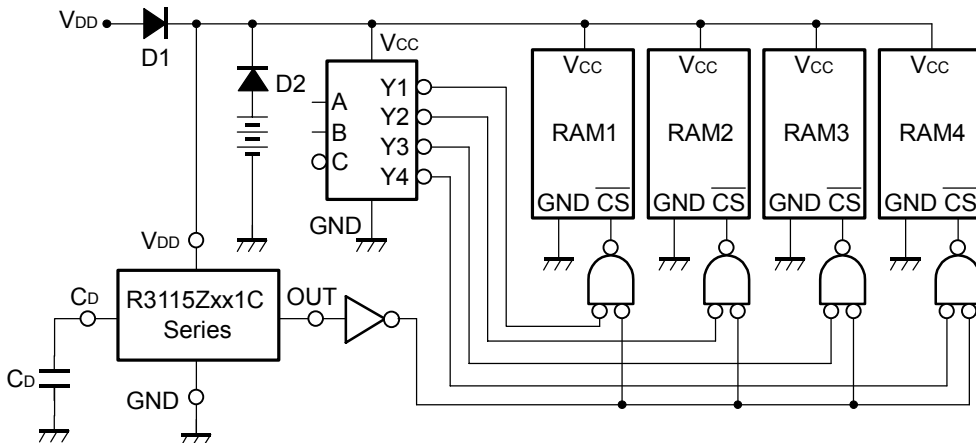

- **Voltage level Indicator Circuit (lighted when the power runs out)**
(Nch Open Drain Output)

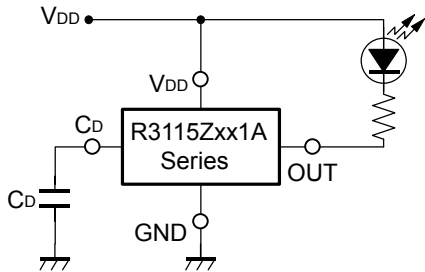

- **Detector Threshold Adjustable Circuit**
(Nch Open Drain Output)

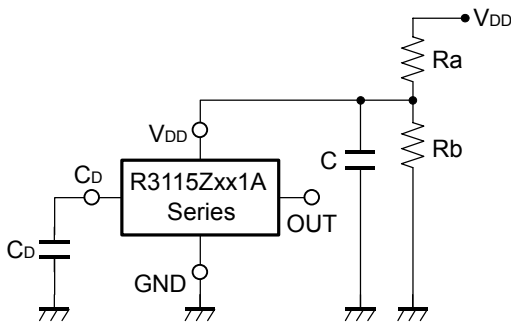

Adjusted Detector Threshold

$$= (-V_{DET}) \times (Ra + Rb) / Rb$$

Hysteresis Voltage

$$= (V_{HYS}) \times (Ra + Rb) / Rb$$

*) If the value of Ra is set excessively large, voltage drop may occur caused by the supply current of IC itself, and detector threshold may vary.

- **Window Comparator Circuit**
(Nch Open Drain Output)

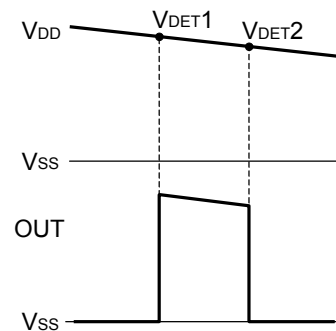
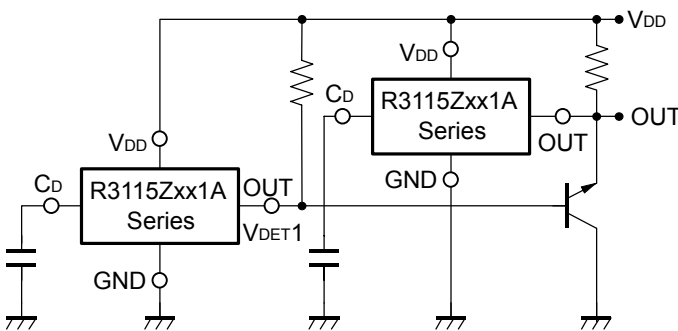

- **Over-charge preventing Circuit**

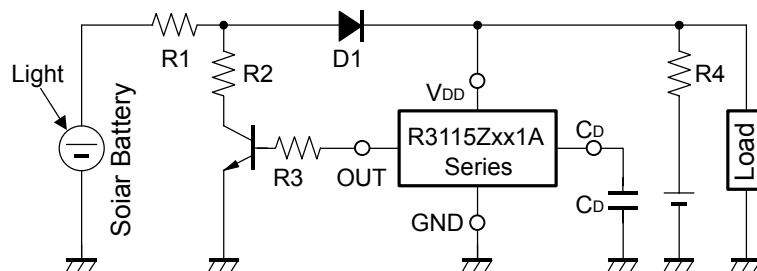

TECHNICAL NOTES

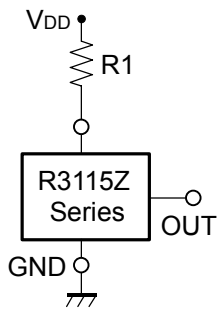

Figure A

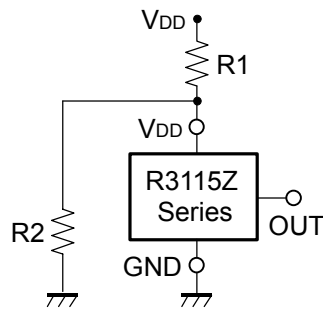

Figure B

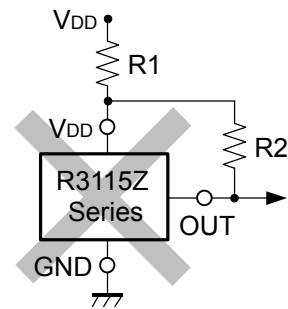

Figure C

When R3115Zxx1A (Nch Open Drain Output Type) is used in Figure A or Figure B, if Impedance of Voltage Supply pin, V_{DD} and V_{DD} of this IC is large, detector threshold level would shift by voltage drop down caused by the consumption current of the IC itself. Released voltage may also shift and delay time for start-up might be generated by this usage.

When R3115Zxx1C (CMOS Output Type) is used in Figure A or Figure B, Output level could be unstable by cross conduction current which is generated at detector threshold level or at released voltage level, therefore, do not use R3115Zxx1C with the connection in Figure A or Figure B.

The connection in Figure C may cause the oscillation in both R3115Zxx1C (CMOS Output) and R3115Zxx1A (Nch Open Drain Output), therefore do not use R3115Zxx1x Series with the connection in Figure C.

POWER DISSIPATION (WLCSP-4-P2)

This specification is at mounted on board. Power Dissipation (P_D) depends on conditions of mounting on board. This specification is based on the measurement at the condition below:

Measurement Conditions

	Standard Land Pattern
Environment	Mounting on Board (Wind velocity=0m/s)
Board Material	Glass cloth epoxy plactic (Double sided)
Board Dimensions	40mm × 40mm × 1.6mm
Copper Ratio	Top side : Approx. 50% , Back side : Approx. 50%
Through-hole	-

Measurement Result

($T_{opt}=25^{\circ}\text{C}$, $T_{jmax}=125^{\circ}\text{C}$)

	Standard Land Pattern
Power Dissipation	530mW
Thermal Resistance	$\theta_{ja}=(125-25^{\circ}\text{C})/0.53\text{W}=189^{\circ}\text{C/W}$

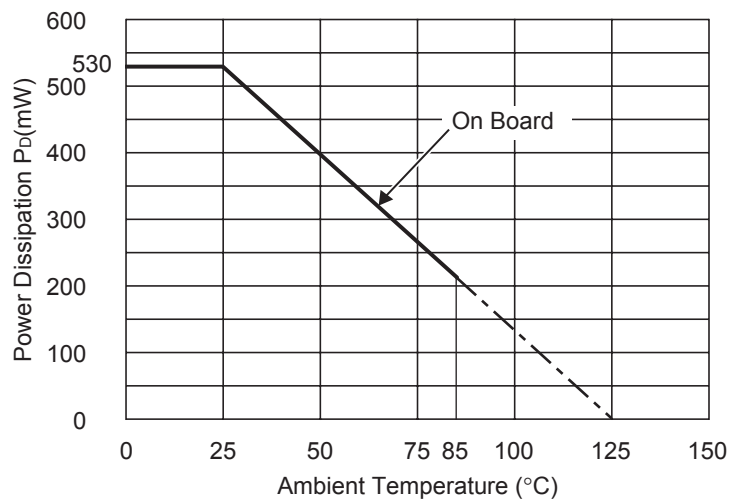

Power Dissipation

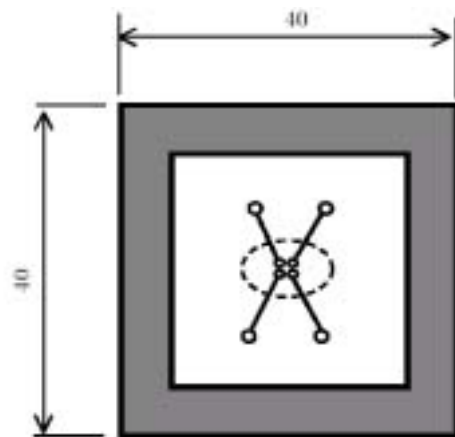

Measurement Board Pattern

○ IC Mount Area (Unit : mm)

RECOMMENDED LAND PATTERN

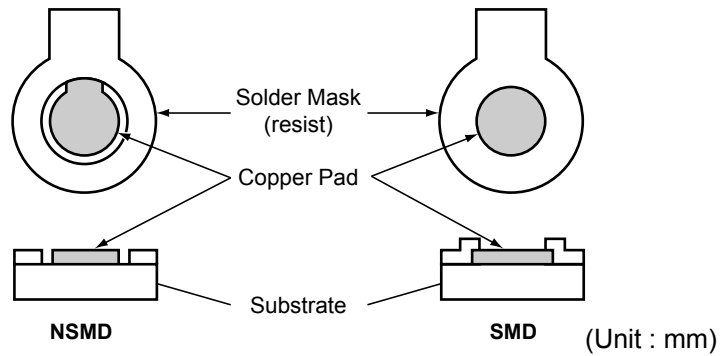

NSMD and SMD Pad Definition

Pad definition	Copper Pad	Solder Mask Opening
NSMD (Non-Solder Mask defined)	0.20mm	Min. 0.30mm
SMD (Solder Mask defined)	Min. 0.30mm	0.20mm

- * Pad layout and size can be modified by customers material, equipment, method.
- * Please adjust pad layout according to your conditions.
- * Recommended Stencil Aperture Size....ø0.3mm
- * Since lead free WL-CSP components are not compatible with the tin/lead solder process, you shall not mount lead free WL-CSP components using the tin/lead solder paste.

R3115Z SERIES MARK SPECIFICATION

- WLCSP-4-P2

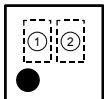

①, ② : Lot Number

(A part number is discriminable from a lot number)