

QTLP601C-2 HER

QTLP601C-3 Yellow

QTLP601C-4 Green

QTLP601C-7 AlGaAs Red

QTLP601C-B Blue

### PACKAGE DIMENSIONS

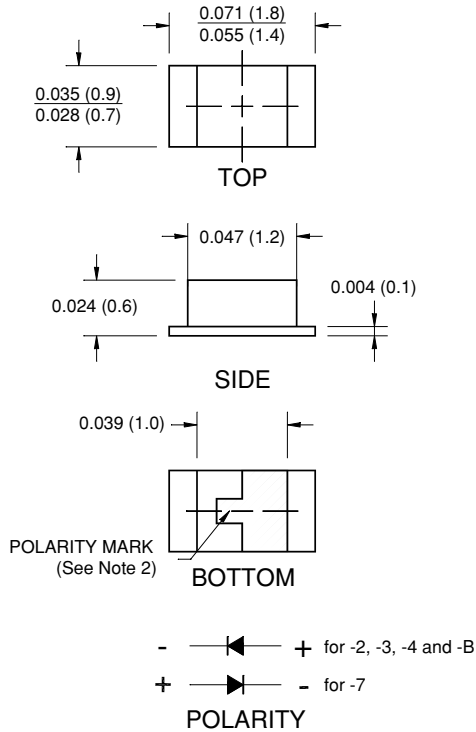

**NOTE:**

1. Dimensions for all drawings are in inches (mm).
2. Cathode for -2, -3, -4 and B. Anode for -7.

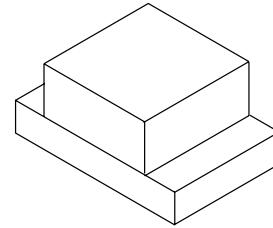

### APPLICATIONS

- Keypad backlighting
- Push-button backlighting
- LCD backlighting

### DESCRIPTION

These surface mount chip LEDs are designed to fit industry standard footprint. Small size, low profile and wide viewing angle make these LEDs ideal choices for backlighting applications and panel illumination.

### FEATURES

- Miniature footprint - 1.6(L) X 0.8(W) X 0.6(H) mm
- Wide viewing angle of 120°
- Water clear optics
- Moisture-proof packaging
- Available in 0.315" (8mm) width tape on 7" (178mm) diameter reel; 2,000 units per reel

# SURFACE MOUNT LED LAMP

## STANDARD BRIGHT 0603 (0.6 mm Height)

QTLP601C-2 HER

QTLP601C-3 Yellow

QTLP601C-4 Green

QTLP601C-7 AlGaAs Red

QTLP601C-B Blue

### ABSOLUTE MAXIMUM RATINGS ( $T_A = 25^\circ\text{C}$ Unless otherwise specified)

Parameter	Symbol	QTLP601C					Units
		-2	-3	-4	-7	-B	
Continuous Forward Current	$I_F$	30	30	30	30	30	mA
Peak Forward Current ( $f = 1.0$ KHz, Duty Factor = 1/10)	$I_{FM}$	160	160	160	180	100	mA
Reverse Voltage ( $I_R = 10 \mu\text{A}$ )	$V_R$	5	5	5	5	5	V
Power Dissipation	$P_D$	84	84	84	72	135	mW
Operating Temperature	$T_{OPR}$	-40 to +85					$^\circ\text{C}$
Storage Temperature	$T_{STG}$	-40 to +90					$^\circ\text{C}$
Lead Soldering Time	$T_{SOL}$	260 for 5 sec					$^\circ\text{C}$

### ELECTRICAL / OPTICAL CHARACTERISTICS ( $T_A = 25^\circ\text{C}$ )

Part Number	Symbol	QTLP601C					Condition
		-2	-3	-4	-7	-B	
Luminous Intensity (mcd)	$I_V$	4	3	7	8	15	$I_F = 20\text{mA}$
Minimum							
Typical		6	5	15	15	20	
Forward Voltage (V)	$V_F$	2.8	2.8	2.8	2.4	4.5	$I_F = 20\text{mA}$
Maximum							
Typical		2.0	2.0	2.1	1.9	3.8	
Wavelength (nm)	$\lambda_P$	635	585	565	660	430	$I_F = 20\text{mA}$
Peak							
Dominant	$\lambda_D$	630	590	570	645	465	
Spectral Line Half Width (nm)	$\Delta\lambda$	45	35	30	20	65	$I_F = 20\text{mA}$
Viewing Angle ( $^\circ$ )	$2\Theta_{1/2}$	120	120	120	120	120	$I_F = 20\text{mA}$

**QTLP601C-2 HER**

**QTLP601C-3 Yellow**

**QTLP601C-4 Green**

**QTLP601C-7 AlGaAs Red**

**QTLP601C-B Blue**

**TYPICAL PERFORMANCE CURVES**

**Fig. 1 Forward Current vs. Forward Voltage**

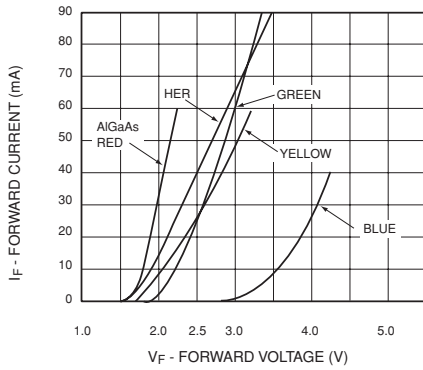

**Fig. 2 Relative Luminous Intensity vs. DC Forward Current**

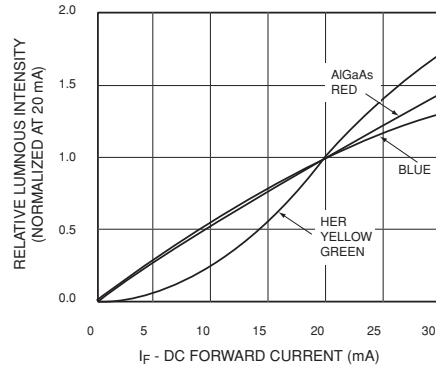

**Fig. 3 Relative Intensity vs. Peak Wavelength**

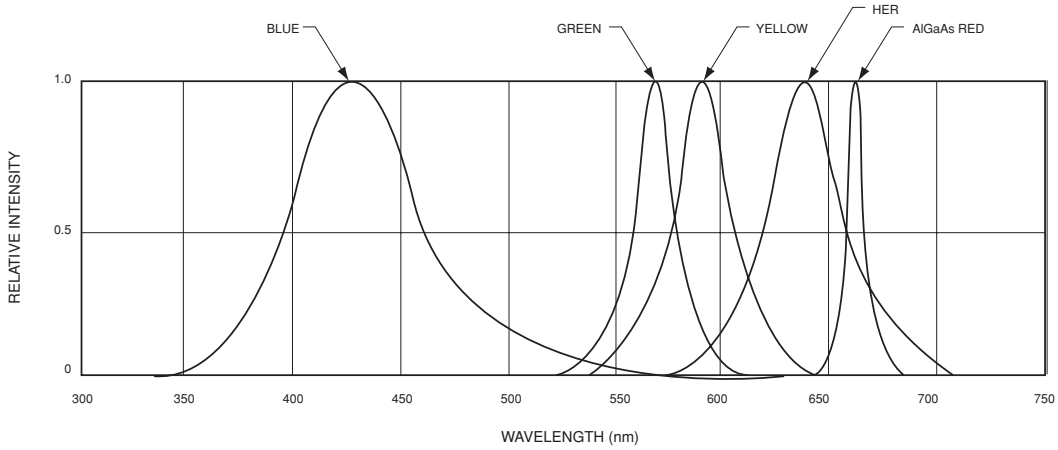

**Fig.4 Radiation Diagram**

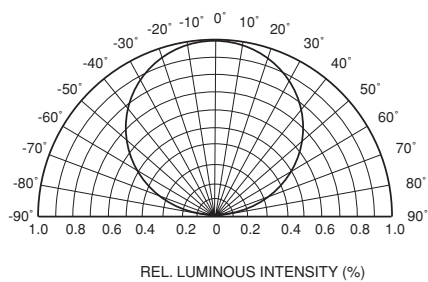

**Fig.5 Maximum Forward Current vs. Ambient Temperature**

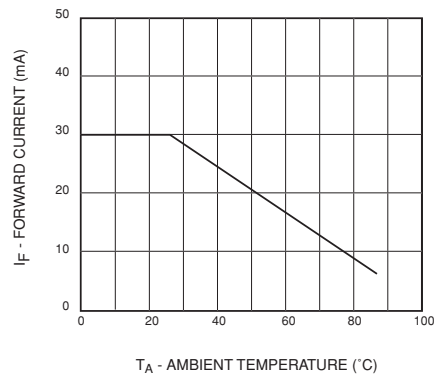

# SURFACE MOUNT LED LAMP STANDARD BRIGHT 0603 (0.6 mm Height)

QTLP601C-2 HER

QTLP601C-3 Yellow

QTLP601C-4 Green

QTLP601C-7 AlGaAs Red

QTLP601C-B Blue

## RECOMMENDED PRINTED CIRCUIT BOARD PATTERN

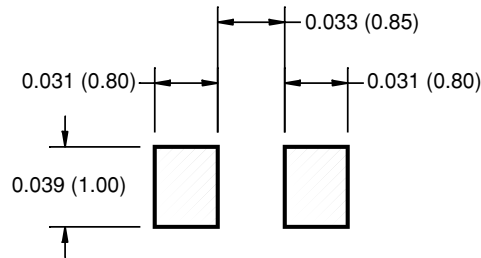

## RECOMMENDED IR REFLOW SOLDERING PROFILE

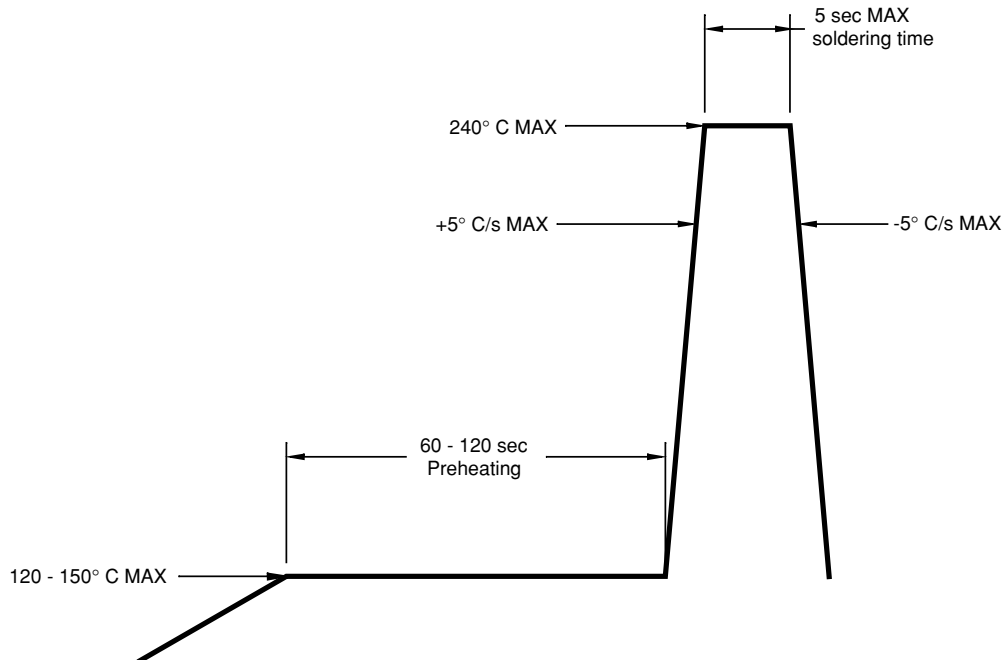

# SURFACE MOUNT LED LAMP STANDARD BRIGHT 0603 (0.6 mm Height)

QTLP601C-2 HER

QTLP601C-3 Yellow

QTLP601C-4 Green

QTLP601C-7 AlGaAs Red

QTLP601C-B Blue

## TAPE AND REEL DIMENSIONS

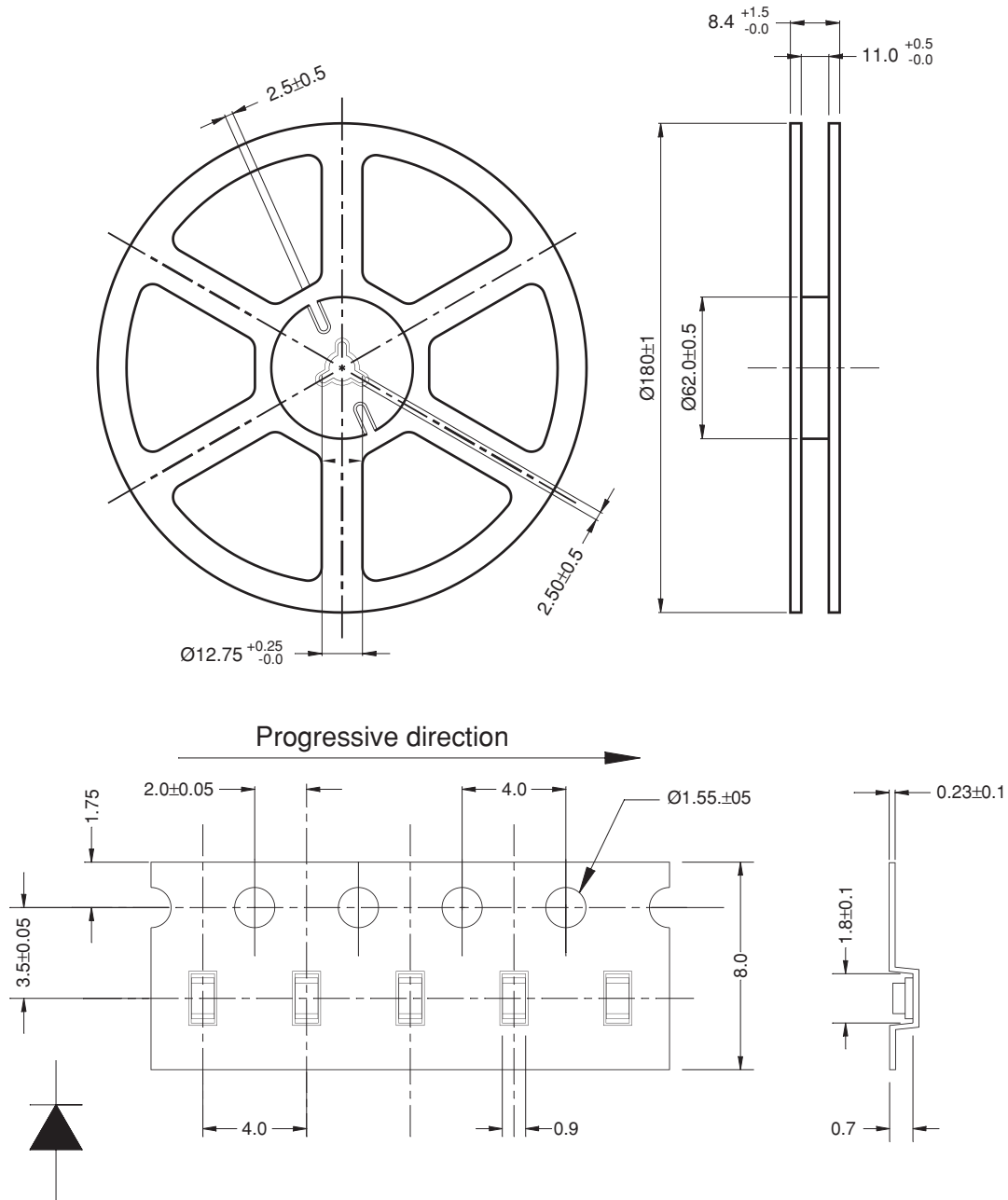

for -2, -3, -4, -B, and -7 Dimensional tolerance is  $\pm 0.1$  mm unless otherwise specified

Polarity

Angle:  $\pm 0.5$

Unit: mm

# SURFACE MOUNT LED LAMP STANDARD BRIGHT 0603 (0.6 mm Height)

---

**QTLP601C-2** HER

**QTLP601C-3** Yellow

**QTLP601C-4** Green

**QTLP601C-7** AlGaAs Red

**QTLP601C-B** Blue

---

## DISCLAIMER

FAIRCHILD SEMICONDUCTOR RESERVES THE RIGHT TO MAKE CHANGES WITHOUT FURTHER NOTICE TO ANY PRODUCTS HEREIN TO IMPROVE RELIABILITY, FUNCTION OR DESIGN. FAIRCHILD DOES NOT ASSUME ANY LIABILITY ARISING OUT OF THE APPLICATION OR USE OF ANY PRODUCT OR CIRCUIT DESCRIBED HEREIN; NEITHER DOES IT CONVEY ANY LICENSE UNDER ITS PATENT RIGHTS, NOR THE RIGHTS OF OTHERS.

## LIFE SUPPORT POLICY

FAIRCHILD'S PRODUCTS ARE NOT AUTHORIZED FOR USE AS CRITICAL COMPONENTS IN LIFE SUPPORT DEVICES OR SYSTEMS WITHOUT THE EXPRESS WRITTEN APPROVAL OF THE PRESIDENT OF FAIRCHILD SEMICONDUCTOR CORPORATION. As used herein:

1. Life support devices or systems are devices or systems which, (a) are intended for surgical implant into the body, or (b) support or sustain life, and (c) whose failure to perform when properly used in accordance with instructions for use provided in the labeling, can be reasonably expected to result in a significant injury of the user.
2. A critical component in any component of a life support device or system whose failure to perform can be reasonably expected to cause the failure of the life support device or system, or to affect its safety or effectiveness.