

Powerex, Inc., 200 Hillis Street, Youngwood, Pennsylvania 15697-1800 (724) 925-7272

Fast Recovery Diode Module
400 Amp/1400 Volts

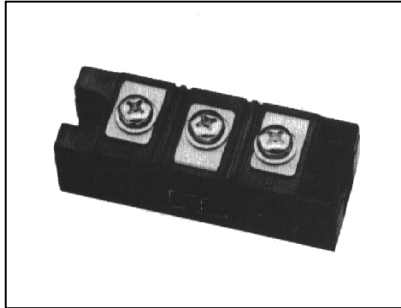
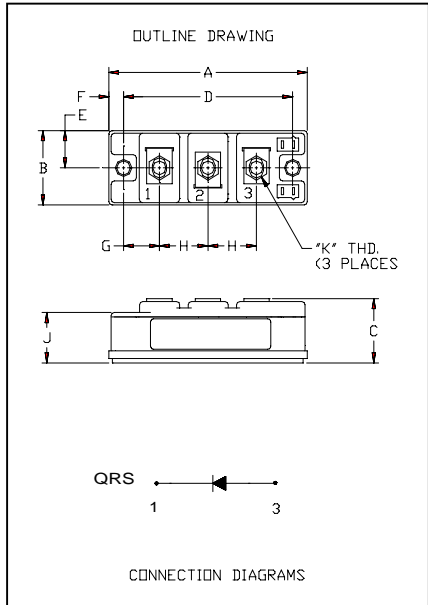

QRS1440T30
Fast Recovery Diode Module
 400 Amperes / 1400 Volts

Description:

Powerex Fast Recovery Diode Modules are designed for use in applications requiring fast switching. The modules are isolated for easy mounting with other components on a common heatsink.

Features:

- Fast Recovery Time
- Isolated Mounting
- Metal Baseplate
- Low Thermal Impedance
- 3000 V isolating voltage

Applications:

- Switching Power Supplies
- Inverters
- Choppers
- Welding Power Supplies
- Free Wheeling Diode
- High Frequency Rectifiers

Dimensions	Inches	Millimeters
A	3.70	94
B	1.34	34
C	1.18	30
D	3.15	80
E	0.67	17
F	0.28	6.99
G	0.67	17.1
H	0.91	23
J	0.91	23
K	M6X1.0	M6X1.0



Preliminary

QRS1440T30
400 Amp/1400 Volts

Powerex, Inc., 200 Hillis Street, Youngwood, Pennsylvania 15697-1800 (724) 925-7272

Fast Recovery Diode Module
400 Amp/1400 Volts

Absolute Maximum Ratings, T_J=25°C unless otherwise specified

Characteristics	Conditions	Symbol	QRS1440T30	Units
Repetitive Peak Reverse Blocking Voltage	-	V _{RRM}	1400	Volts
Non-Repetitive Peak Reverse Blocking Voltage	-	V _{RSM}	V _{RRM} + 100	Volts
Average Forward Current	180° Conduction, T _c =25°C	I _{F(AV)}	400	Amperes
Peak Half Cycle Non-Repetitive Surge Current	t = 8.3mS, 100%V _{RRM} Reapplied	I _{FSM}	2670	Amperes
I ² t for Fusing for One Cycle	t = 8.3mS, 100%V _{RRM} Reapplied	I ² t	29700	A ² sec
Operating Junction Temperature	-	T _J	-40 to 150	°C
Storage Temperature	-	T _{STG}	-40 to 150	°C
Maximum Mounting Torque, M6 Mounting Screw	-	-	26	In.-lb.
Maximum Terminal Torque, M6 Terminal Screw	-	-	26	In.-lb.
Module Weight (Typical)	-	-	220	Grams
V Isolation	60 Hz, circuit to base, all terminals shorted, t = 1 sec	V _{RMS}	3000	Volts

Electrical Characteristics, T_J=25°C unless otherwise specified

Characteristics	Symbol	Test Conditions	Min.	Typ.	Max.	Units
Peak Reverse Leakage Current	I _{RRM}	Rated V _{RRM}	-	-	2	mA
Peak On-State Voltage	V _{FM}	I _F =400A	-	-	3.8	Volts
Reverse Recovery Time	t _{rr}	I _F = 400A, di/dt = -800A/μs	-	-	300	ns
Reverse Recovery Charge	Q _{rr}	I _F = 400A, di/dt = -800A/μs	-	4.0	-	μC

Thermal Characteristics, T_J=25°C unless otherwise specified

Characteristics	Symbol	Min.	Typ.	Max.	Units
Thermal Resistance, Junction to Case	R _{θJC}	-	-	0.09	°C/Watt
Thermal Resistance, Case to Sink Lubricated	R _{θCS}	-	-	0.04	°C/Watt

Powerex, Inc., 200 Hillis Street, Youngwood, Pennsylvania 15697-1800 (724) 925-7272

Fast Recovery Diode Module
400 Amp/1400 Volts

