

TRANSISTOR MODULE

QCA75AA100



UL;E76102 (M)

QCA75AA100 is a dual Darlington power transistor module which has series-connected high speed, high power Darlington transistors. Each transistor has a reverse paralleled fast recovery diode. The mounting base of the module is electrically isolated from semiconductor elements for simple heatsink construction,

- $I_C=75A$, $V_{CEX}=1000V$
- Low saturation voltage for higher efficiency.
- High DC current gain h_{FE}
- Isolated mounting base

(Applications)

Motor Control (VVVF), AC/DC Servo, UPS, Switching Power Supply, Ultrasonic Application

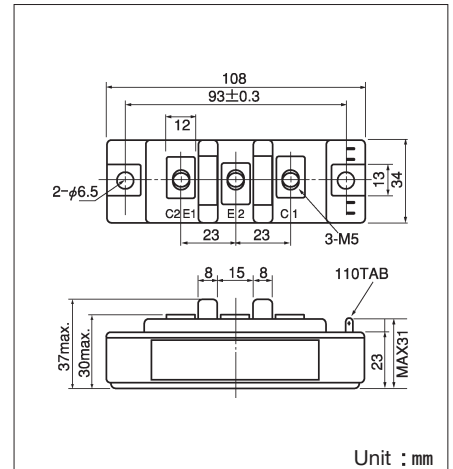
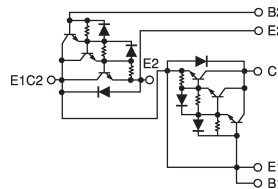

Maximum Ratings

($T_j=25^\circ C$)

Symbol	Item	Conditions	Ratings		
			QCA75AA100	Unit	
V_{CBO}	Collector-Base Voltage		1000	V	
V_{CEX}	Collector-Emitter Voltage	$V_{BE} = -2V$	1000	V	
V_{EBO}	Emitter-Base Voltage		7	V	
I_C	Collector Current		75	A	
$-I_C$	Reverse Collector Current		75	A	
I_B	Base Current		4	A	
P_T	Total power dissipation	$T_C = 25^\circ C$	500	W	
T_j	Junction Temperature		-40 ~ +150	$^\circ C$	
T_{stg}	Storage Temperature		-40 ~ +125	$^\circ C$	
V_{ISO}	Isolation Voltage	A.C.1minute	2500	V	
	Mounting Torque	Mounting (M6)	Recommended Value 2.5~3.9 (25~40)	4.7 (48)	N·m kgf·cm
		Terminal (M5)	Recommended Value 1.5~2.5 (15~25)	2.7 (28)	
	Mass	Typical Value	250	g	

Electrical Characteristics

($T_j=25^\circ C$)

Symbol	Item	Conditions	Ratings		Unit
			Min.	Max.	
I_{CBO}	Collector Cut-off Current	$V_{CB} = 1000V$		1.0	mA
I_{EBO}	Emitter Cut-off Current	$V_{EB} = 7V$		200	mA
$V_{CEX(SUS)}$	Collector Emitter Sustaining Voltage	$I_C = 15A$, $I_{B2} = -4A$	1000		V
h_{FE}	DC Current Gain	$I_C = 75A$, $V_{CE} = 2.8V$	75		
		$I_C = 75A$, $V_{CE} = 5V$	100		
$V_{CE(sat)}$	Collector-Emitter Saturation Voltage	$I_C = 75A$, $I_B = 1.5A$		2.5	V
$V_{BE(sat)}$	Base-Emitter Saturation Voltage	$I_C = 75A$, $I_B = 1.5A$		3.5	V
t_{on}	Switching Time	On Time		2.5	μs
t_s		Storage Time	$V_{CC} = 600V$, $I_C = 75A$ $I_{B1} = 1.5A$, $I_{B2} = -1.5A$	15.0	
t_f		Fall Time		3.0	
V_{ECO}	Collector-Emitter Reverse Voltage	$-I_C = 75A$		1.8	V
$R_{th(j-c)}$	Thermal Impedance (junction to case)	Transistor part		0.25	$^\circ C/W$
		Diode part		1.20	

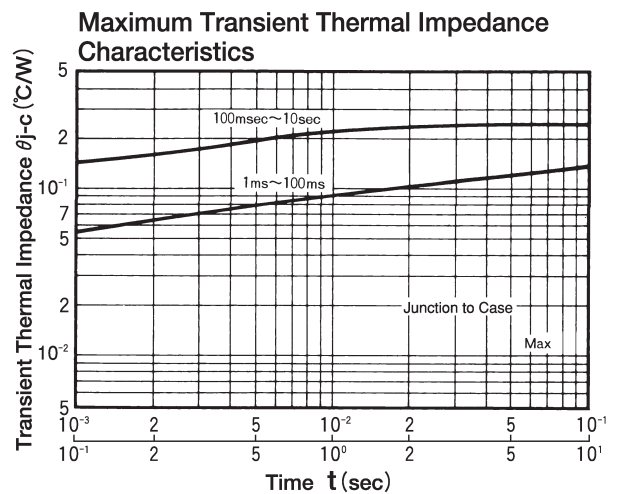
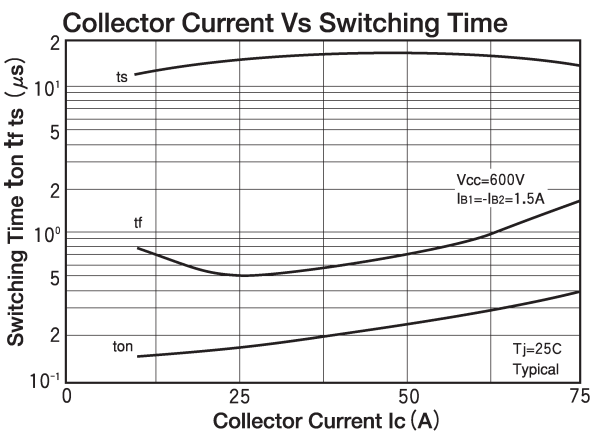
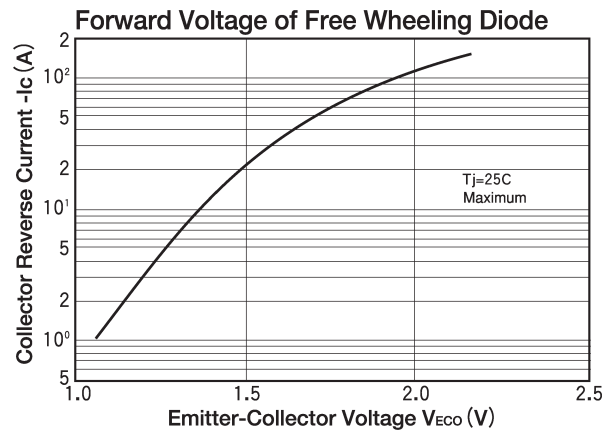
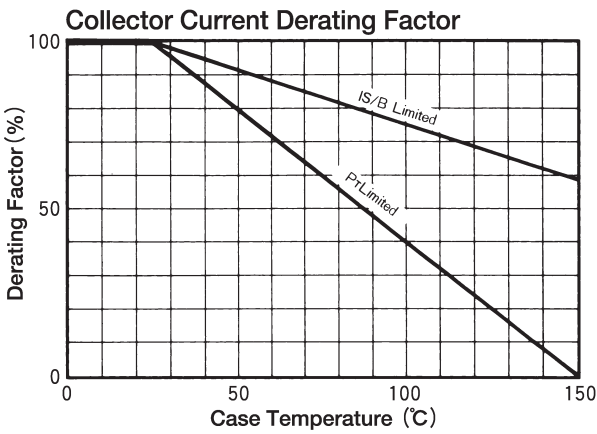
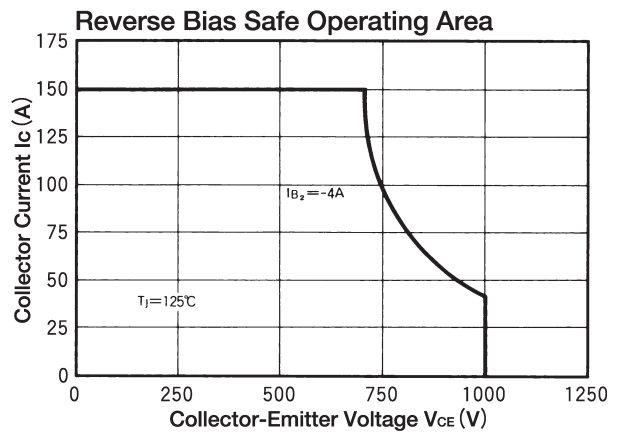
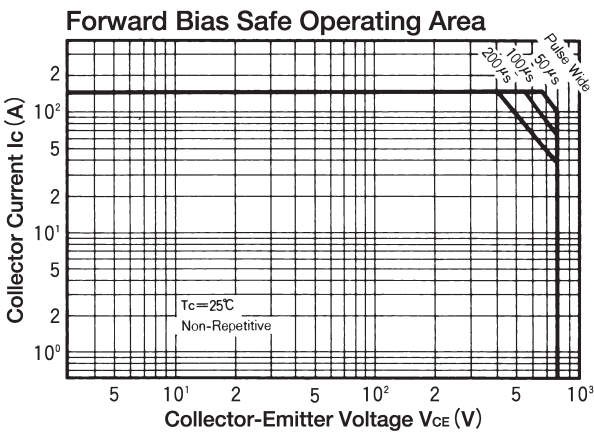
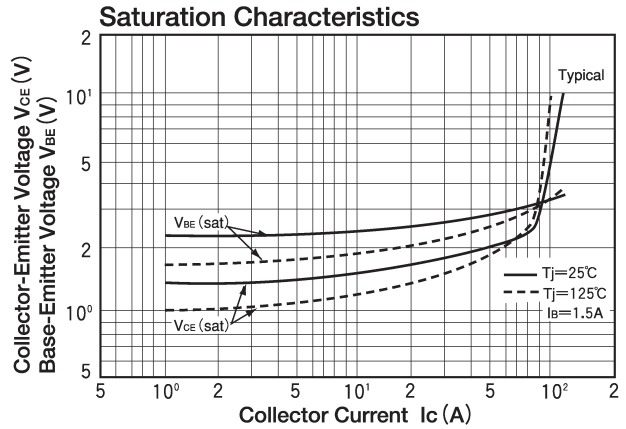
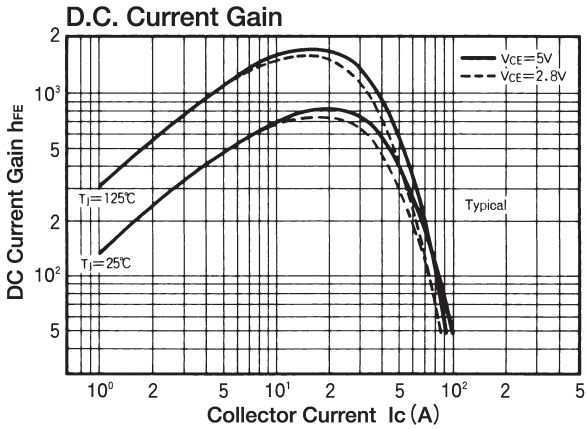

TRANSISTOR MODULE

QCA75AA120



UL;E76102 (M)

QCA75AA120 is a dual Darlington power transistor module which has series-connected high speed, high power Darlington transistors. Each transistor has a reverse paralleled fast recovery diode. The mounting base of the module is electrically isolated from semiconductor elements for simple heatsink construction,

- $I_C=75A$, $V_{CEX}=1200V$
- Low saturation voltage for higher efficiency.
- High DC current gain h_{FE}
- Isolated mounting base

(Applications)

Motor Control (VVVF), AC/DC Servo, UPS,
Switching Power Supply, Ultrasonic Application

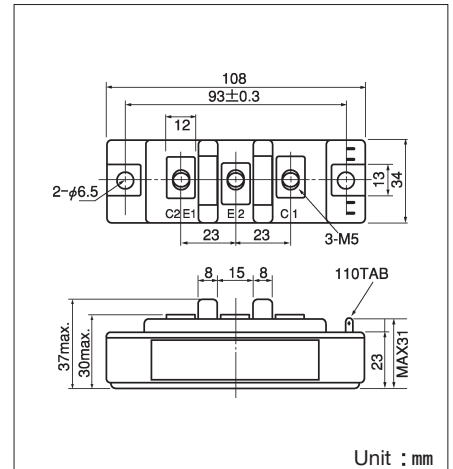
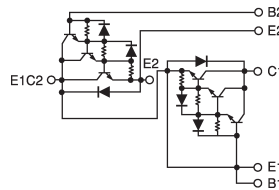

Maximum Ratings

($T_j=25^\circ C$)

Symbol	Item	Conditions	Ratings		
			QCA75AA120	Unit	
V_{CBO}	Collector-Base Voltage		1200	V	
V_{CEX}	Collector-Emitter Voltage	$V_{BE} = -2V$	1200	V	
V_{EBO}	Emitter-Base Voltage		10	V	
I_C	Collector Current		75	A	
$-I_C$	Reverse Collector Current		75	A	
I_B	Base Current		4	A	
P_T	Total power dissipation	$T_C=25^\circ C$	500	W	
T_j	Junction Temperature		-40~+150	$^\circ C$	
T_{stg}	Storage Temperature		-40~+125	$^\circ C$	
V_{ISO}	Isolation Voltage	A.C.1minute	2500	V	
	Mounting Torque	Mounting (M6)	Recommended Value 2.5~3.9 (25~40)	4.7 (48)	N·m (kgf·cm)
		Terminal (M5)	Recommended Value 1.5~2.5 (15~25)	2.7 (28)	
	Mass	Typical Value	250	g	

Electrical Characteristics

($T_j=25^\circ C$)

Symbol	Item	Conditions	Ratings		Unit
			Min.	Max.	
I_{CBO}	Collector Cut-off Current	$V_{CB}=1200V$		1.0	mA
I_{EBO}	Emitter Cut-off Current	$V_{EB}=10V$		300	mA
$V_{CEX(SUS)}$	Collector Emitter Sustaining Voltage	$I_C=15A$, $I_{B2}=-3A$	1200		V
h_{FE}	DC Current Gain	$I_C=75A$, $V_{CE}=5V$	75		
$V_{CE(sat)}$	Collector-Emitter Saturation Voltage	$I_C=75A$, $I_B=1.5A$		3.0	V
$V_{BE(sat)}$	Base-Emitter Saturation Voltage	$I_C=75A$, $I_B=1.5A$		3.5	V
t_{on}	Switching Time	On Time		2.5	μs
t_s		Storage Time	$V_{CC}=600V$, $I_C=75A$ $I_{B1}=1.5A$, $I_{B2}=-1.5A$	15.0	
t_f		Fall Time		3.0	
V_{ECO}	Collector-Emitter Reverse Voltage	$-I_C=75A$		1.8	V
$R_{th(j-c)}$	Thermal Impedance (junction to case)	Transistor part		0.25	$^\circ C/W$
		Diode part		1.2	

D.C. Current Gain

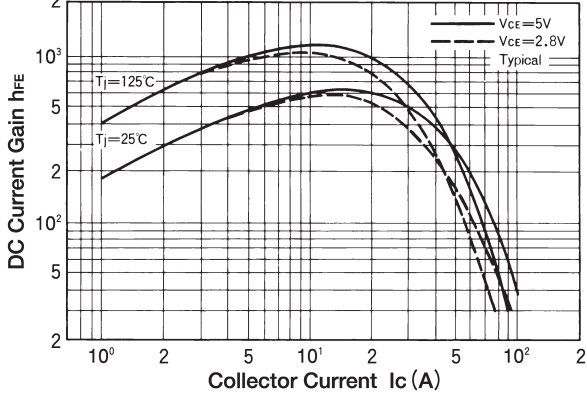

Saturation Characteristics

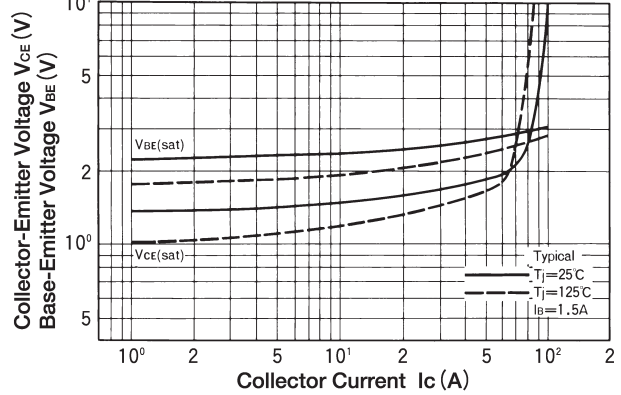

Forward Bias Safe Operating Area

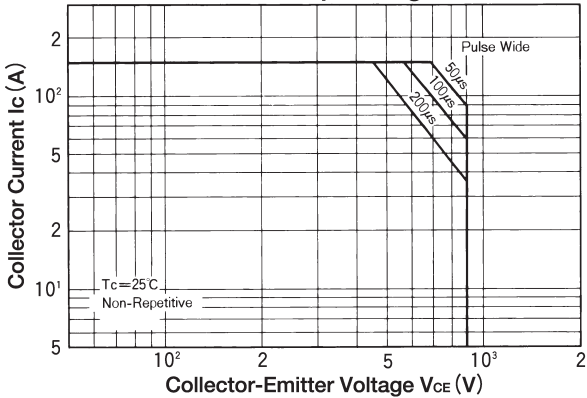

Reverse Bias Safe Operating Area

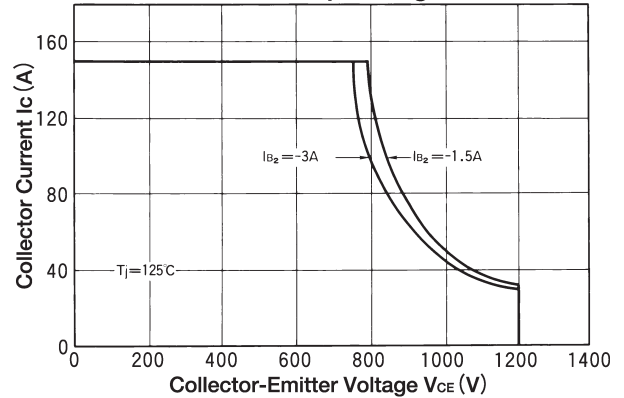

Collector Current Derating Factor

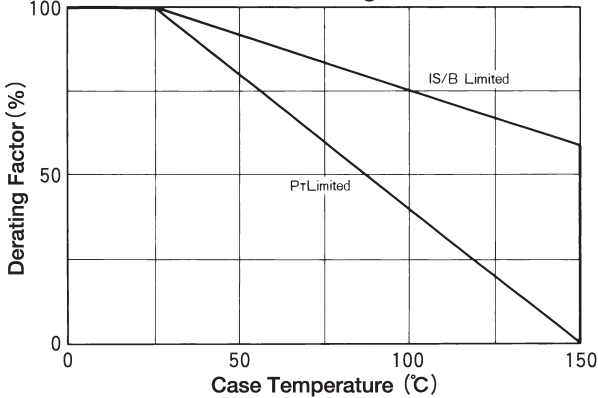

Forward Voltage of Free Wheeling Diode

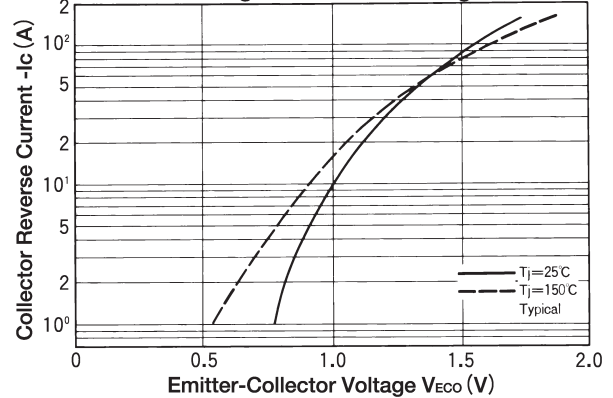

Collector Current Vs Switching Time

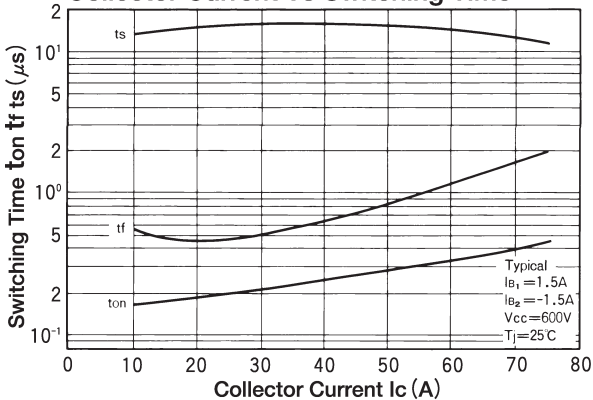

Maximum Transient Thermal Impedance Characteristics

