

■回路図 CIRCUIT

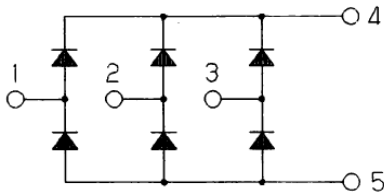

■外形寸法図 OUTLINE DRAWING

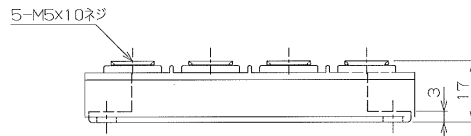
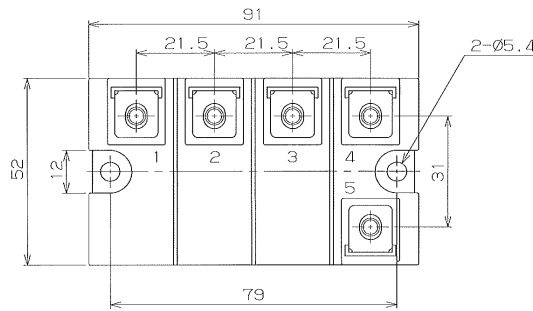

Dimension: [mm]

■最大定格 Maximum Ratings

項目 Parameter	記号 Symbol	耐圧クラス Grade		単位 Unit
		PT200KN16		
くり返しピーク逆電圧 Repetitive Peak Reverse Voltage	*1 V _{RRM}	1600		V
非くり返しピーク逆電圧 Non Repetitive Peak Reverse Voltage	*1 V _{RSM}	1700		V

項目 Parameter	記号 Symbol	条件 Conditions	定格値 Max. Rated Value	単位 Unit	
平均出力電流 Average Rectified Output Current	I _{O(AV)}	三相全波整流 3-Phase Full Wave Rectified T _c =T _t =110°C (T _c : 測定点チップ直下/T _t : Terminal)	200	A	
サージ順電流 Surge Forward Current	*1 I _{FSM}	50Hz 正弦半波, 1サイクル, 非くり返し Half Sine Wave, 1Pulse, Non-Repetitive	2000	A	
電流二乗時間積 I Squared t	*1 I ² t	2~10ms	20000	A ² s	
動作接合温度範囲 Operating Junction Temperature Range	T _{jw}		-40 ~ +150	°C	
保存温度範囲 Storage Temperature Range	T _{stg}		-40 ~ +125	°C	
絶縁耐圧 Isolation Voltage	V _{iso}	端子-ベース間, AC 1分間 Terminal to Base, AC 1min.	2500	V	
締付トルク Mounting Torque	ベース部 Mounting	F	5-M5	2.4 ~ 2.8	N・m
	主端子部 Terminal		5-M5	2.4 ~ 2.8	N・m

■電気的特性 Electrical Characteristics

項目 Parameter	記号 Symbol	条件 Conditions	特性値 (最大) Maximum Value	単位 Unit
ピーク逆電流 Peak Reverse Current	*1 I _{RM}	T _j =150°C, V _{RM} =V _{RRM}	10	mA
ピーク順電圧 Peak Forward Voltage	*1 V _{FM}	T _j =25°C, I _{FM} =200A	1.45	V
熱抵抗 Thermal Resistance	R _{th(j-c)}	接合部-ケース間 (トルク: T _c 測定点チップ直下) Junction to Case, Total	0.05	°CW
接触熱抵抗 Thermal Resistance	R _{th(c-f)}	ケース-フィン間 (トルク), サマロパウト塗布 Case to Fin, Total, Greased	0.06	°CW

質量 --- 約 210g
Approximate Weight

*1: 1アーム当りの値 Value Per 1 Arm.

順電圧特性
FORWARD CURRENT VS. VOLTAGE

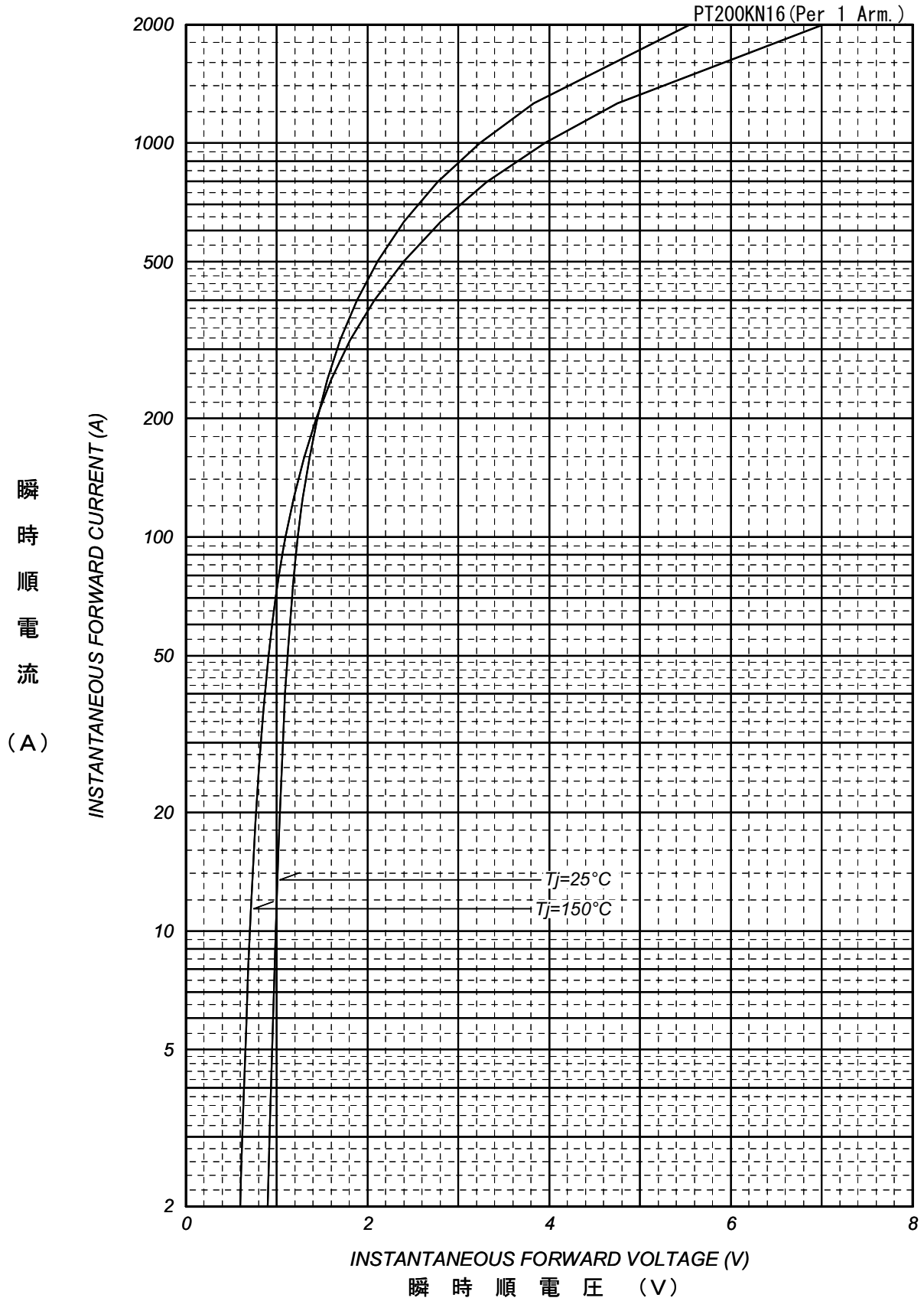

平均順電力損失特性
AVERAGE FORWARD POWER DISSIPATION

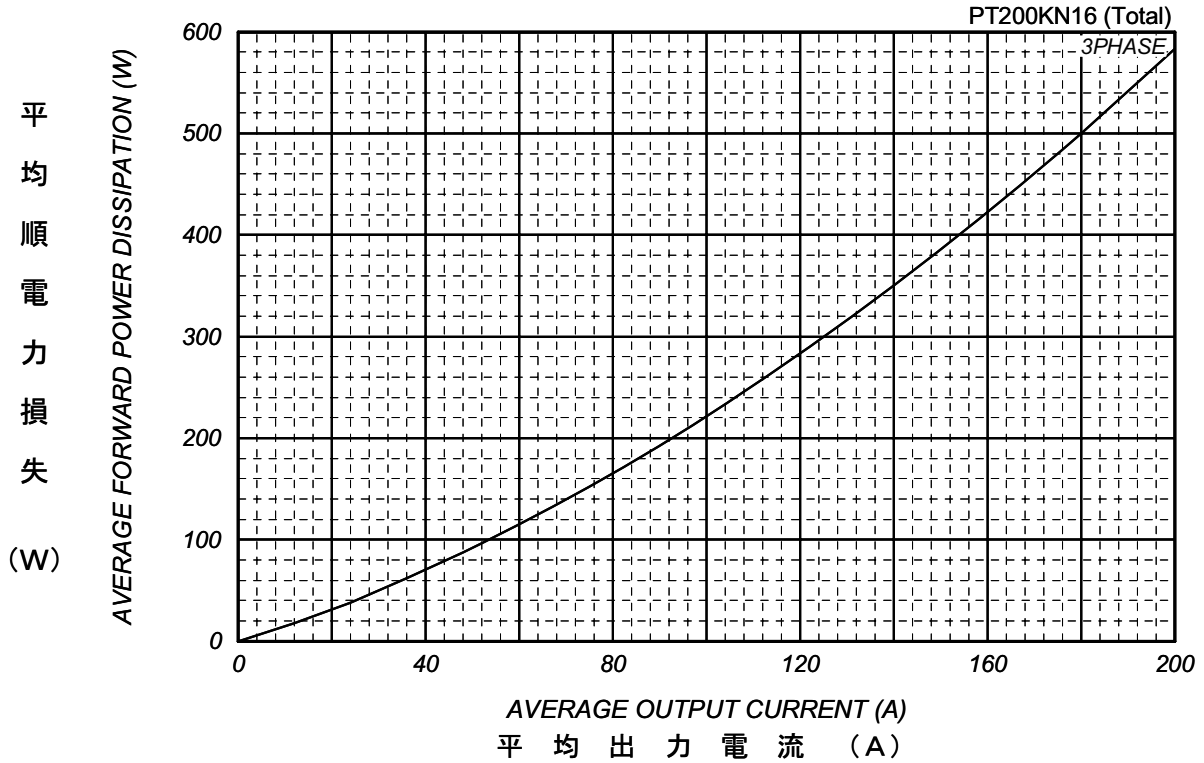

平均出力電流 - ケース温度定格
AVERAGE OUTPUT CURRENT VS. CASE TEMPERATURE

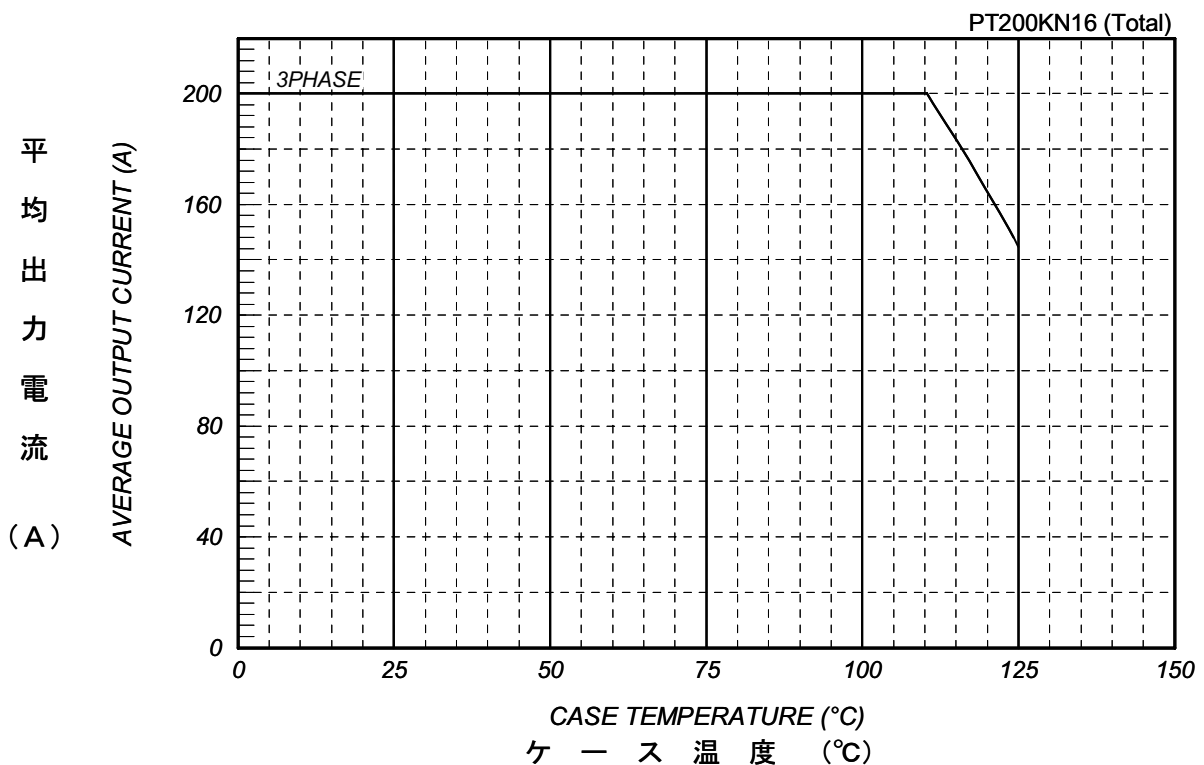

サージ順電流定格
SURGE CURRENT RATINGS

f=50Hz, Half Sine Wave, Non-Repetitive, Tj=150°C

PT200KN16 (Per 1 Arm.)

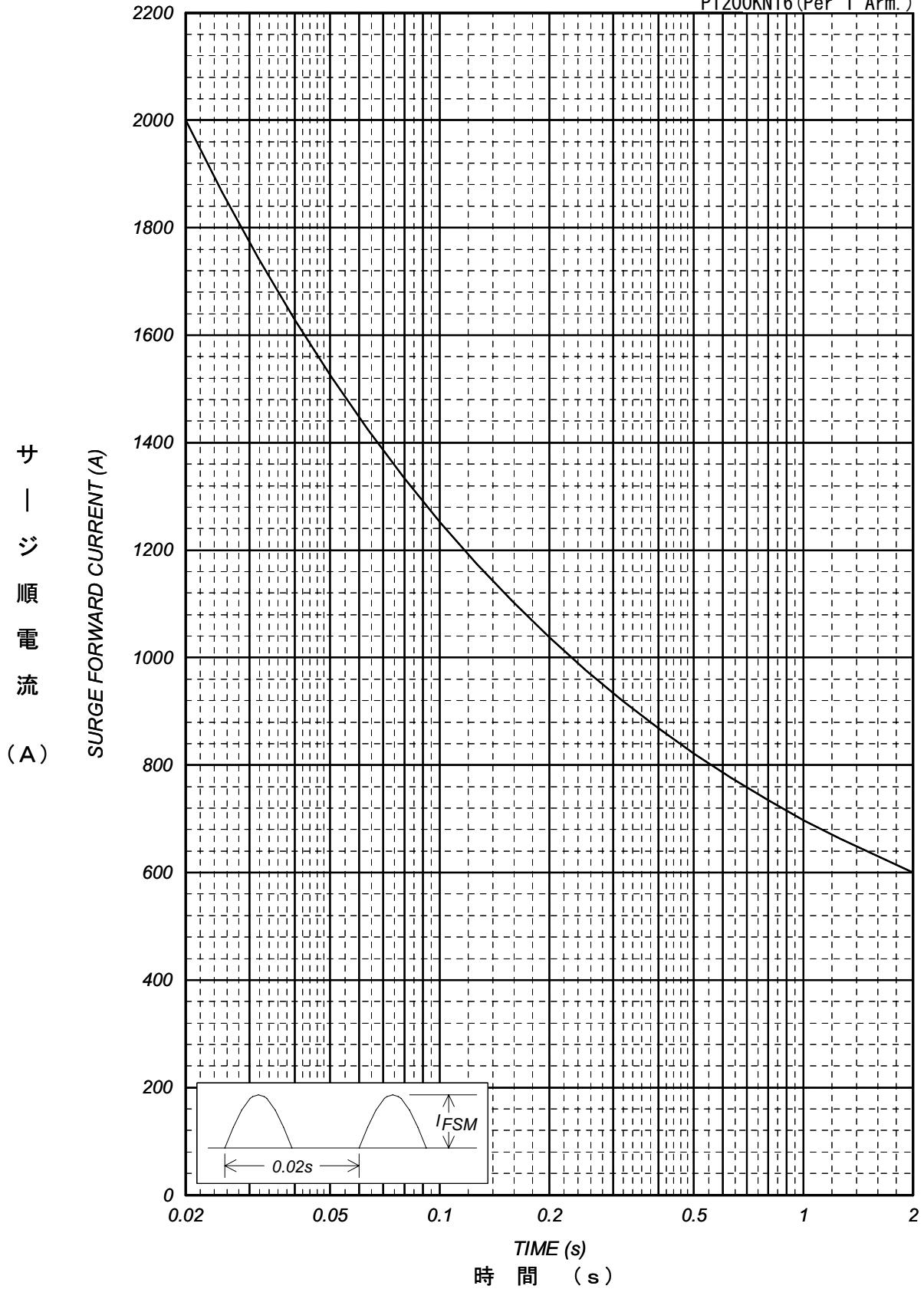

過渡熱抵抗特性
Transient Thermal Impedance

