

Tone Ringer (TRI)

PSB 652X-Y

Bipolar IC

Special Features and Ordering Codes of the Different Devices

Typ	Tone Frequency		Integrated Z-Diode	Package	Ordering Code
	Ratio	Tolerance			
PSB 6520-2	1.38	± 5%	yes	P-DIP-8	Q67000-A8093
PSB 6521-2	1.25	± 5%	yes	P-DIP-8	Q67000-A8094
PSB 6523-T	1.25	± 5% select. (delivered in four colour groups)	no	Miniature plastic package similar to P-DSO-8 (SMD)	Q67000-A8073

The bipolar tone ringer ICs in conjunction with an electro-acoustic converter, replace the mechanical bell in a telephone set (**figure 1**). The components generate two periodic, switchable tone frequencies and can either directly drive a piezo-ceramic converter or a loudspeaker (with high impedance).

Features

- Integrated bridge rectifier allows direct input via call signal (AC voltage)
- Low current consumption (several tone ringers can be connected in parallel)
- High noise immunity due to built-in voltage-current hysteresis
- Direct replacement of the mechanical bell requiring only few additional external components and an acoustic converter
- Two tone frequencies, switched internally
- Tone and switching frequencies adjustable by means of a resistor and a capacitor
- Overvoltage protection

Pin Configuration (top view)

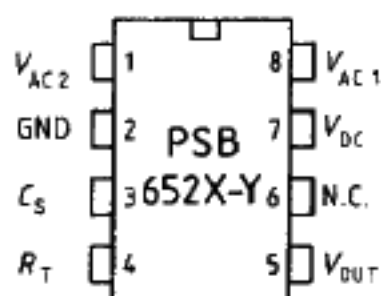

Pin Definitions and Functions

Pin No.	Symbol	Function
1	V_{AC2}	AC voltage input
2	GND	Ground
3	C_S	Connection for capacitor C_S
4	R_T	Connection for resistor R_T
5	V_{OUT}	Output voltage
6	N.C.	Not connected
7	V_{DC}	Connection for smoothing capacitor $C_2 = 10 \mu\text{F}$ (internal supply voltage) (PSB 6523-T: connection also for Z-diode ZD)
8	V_{AC1}	AC voltage input

Figure 1

Block Diagram of a Standard Electronic Telephone Set

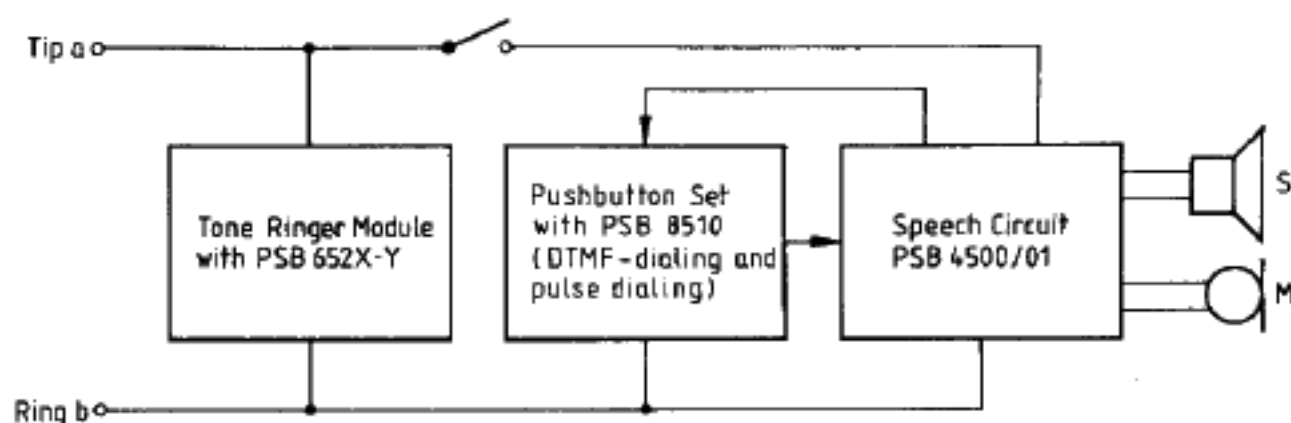

Functional Description

The tone ringer devices PSB 652X-Y are designed for use as an electronic bell in a telephone set. **Figure 2** shows the block diagram and **figure 3** the circuit example of the PSB 652X-Y in a telephone set.

Figure 2
Block Diagram of the PSB 652X-Y Tone Ringers

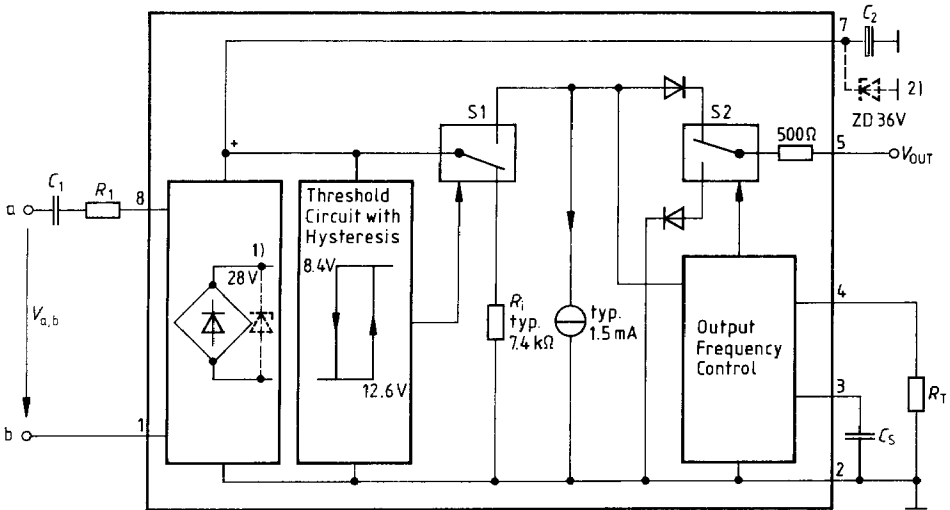

- 1) integrated Z-diode, no external Z-diode necessary: PSB 6520-2
PSB 6521-2
- 2) external Z-diode necessary, no integrated Z-diode: PSB 6523-T

The ICs contain an oscillator which generates a square wave voltage. The frequency of this voltage is periodically switched by a second oscillator back and forth between two values f_{1T} and f_{2T} having a certain ratio. The switching frequency f_s is adjusted by the capacitor C_s . The basic frequency f_{1T} is adjusted by the resistor R_T .

The diagrams in **figure 12 and 13** show the relationship.

The formulas to calculate the frequencies of the different devices are:

a) **Switching Frequency** (commonly valid) $f_s \text{ [Hz]} = \frac{750}{C \text{ [nF]}}$

b) **Tone Frequencies** (individual)

PSB 6520-2: $f_{1T} \text{ [Hz]} = \frac{2.72 \times 10^4}{R \text{ [k}\Omega\text{]}}$

$$f_{2T} = \frac{1}{1.38} \times f_{1T}$$

PSB 6521-2: $f_{1T} \text{ [Hz]} = \frac{1.7888 \times 10^4}{R \text{ [k}\Omega\text{]}}$

$$f_{2T} = \frac{1}{1.25} \times f_{1T}$$

PSB 6523-T:

Colour code:

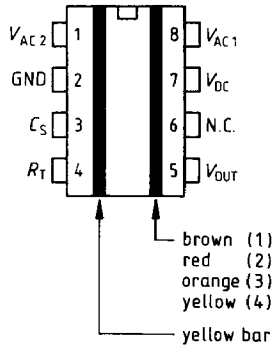

Group 1
(yellow/brown bar)

$$f_{1T} \text{ [Hz]} = \frac{1.7888 \times 10^4}{R \text{ [k}\Omega\text{]}}$$

Group 2
(yellow/red bar)

$$f_{1T} \text{ [Hz]} = \frac{1.9608 \times 10^4}{R \text{ [k}\Omega\text{]}}$$

Group 3
(yellow/orange bar)

$$f_{1T} \text{ [Hz]} = \frac{1.6336 \times 10^4}{R \text{ [k}\Omega\text{]}}$$

Group 4
(yellow/yellow bar)

$$f_{1T} \text{ [Hz]} = \frac{2.1568 \times 10^4}{R \text{ [k}\Omega\text{]}}$$

$$f_{2T} = \frac{1}{1.25} \times f_{1T}$$

Good frequency stability is achieved by means of internal temperature compensation.

An output stage increases the generated tone voltage and transfers it to a piezo-resonator via an internal resistor. An electro-dynamic converter (low impedance loudspeaker) can be similarly driven, but must be matched to the internal resistance of the output stage (fig. 6, 7, 8 and 12) with a transformer.

An integrated bridge rectifier enables direct input via the call AC voltage signal, between tip (a) and ring (b) wires or via DC voltage (independent of polarity). A DC voltage supply without use of the integrated bridge is possible via the connections 2 and 7. In conjunction with an integrated or external Z-diode, the bridge rectifier serves simultaneously as an overvoltage protection.

The application circuit shown in **figure 3** can handle overvoltages occurring due to lightning strikes between terminals a and b, or the occurrence of an AC voltage of 110 V/50 Hz over a period of 30 s. So a possible damaging of the IC is prevented. The threshold circuit with high threshold voltage and hysteresis is designed to prevent activation of the IC due to noise pulses (**figure 4**).

Figure 3

Application Circuit of PSB 652X-Y for Telephone Sets (example)

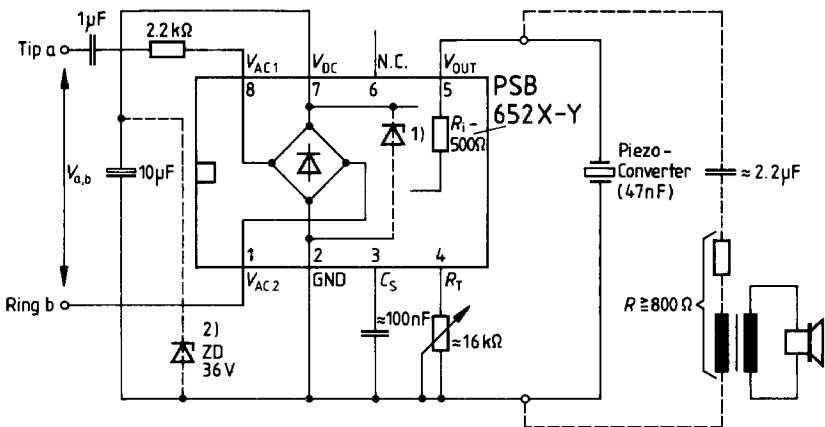

1) Integrated Z-Diode: PSB 6520-2 / PSB 6521-2

2) External Z-Diode Necessary: PSB 6523-T

The characteristic curves from **figure 4** to **figure 6** show the relationship between current consumption, supply voltage, output current, output power, output resistance and calling voltage.

Nominal Values:

$$C_s = 100 \text{ nF}, \quad f_s = 7,5 \text{ Hz}$$

$$R_T = 16 \text{ k}\Omega, \quad f_{1T} \approx 1700 \text{ Hz (PSB 6520-2)}$$

$$f_{1T} \approx 1100 \text{ Hz (PSB 6521-2)}$$

$$\text{PSB 6523-T group 1)}$$

Absolute Maximum Ratings

Parameter	Symbol	Common Values		PSB 6520-2/ 6521-2 Values	PSB 6523-T Values	Unit	Test Conditions
		min.	max.	max.	max.		
AC input voltage (pin 1 to pin 8 peak to peak)	$V_{AC\ 1,8\ pp}$			28	45	V	
DC input voltage (pin 7 to pin 2)	$V_{DC\ 7,2}$			26	40	V	continuous
				28	45	V	for max. 10 ms
Input current (pins 1, 8)	$I_{1\ rms}$		30			mA	continuous
	$I_{8\ rms}$		1			A	ON/OFF operation 100 μ s/30 s
Ringing voltage	V_{ab}		150			V 1.8 s 3.6	test circuit fig. 3 $f = 50\ Hz$ s operation/ pause
Transient current spikes into the output (pin 5)	I_{5T}		± 20			mA	30 μ s pulse 3 ms pause
Voltage applied at C_S (pin 3 to pin 2)	$V_{3,2}$		5.5			V	
Voltage applied at R_T (pin 4 to pin 2)	$V_{4,2}$		7			V	
Operating temperature	T_A	-20	70			$^{\circ}C$	
Storage temperature	T_{stg}	-55	125			$^{\circ}C$	
Junction temperature	T_j		150			$^{\circ}C$	
Thermal resistance junction-air	R_{thJA}			140	210	K/W	

Electrical Characteristics

 $T_A = -20^\circ\text{C}$ to 70°C

Parameter	Symbol	Common Values			PSB 6520-2/ 6521-2 Values	PSB 6523-T Values	Unit	Test Conditions
		min.	typ.	max.	max.	max.		
AC operating input current (pins 1,8)	$I_{AC\ 1\ rms}$ $I_{AC\ 8\ rms}$			18			mA	continuous
				24			mA	ON/OFF operation 5 s/10 s
DC operating input voltage (pin 7 to pin 2)	$V_{DC\ 7,2}$				26	36	V	
DC operating input current	$I_{DC\ 7}$				22	11	mA	$V_{DC\ 7,2} = V_{DC\ 7,2\ max.}$
Power dissipation	$P_{DC\ 7,2}$ or $P_{AC\ 1,8}$				600	400	mW	
DC current consumption without load	$I_{DC\ 7}$		1.5		1.8	1.9	mA	device activated $V_{7,2} = 8.8\ \text{V}$ to max. $V_{DC\ 7,2}$ $T_A = 25^\circ\text{C}^2)$
Turn-on voltage $V_{7,2}$	V_{ON}	12.2	12.6	13.0			V	
Turn-off voltage $V_{7,2}$	V_{OFF}	8.0	8.4	8.8			V	
DC resistance when not activated	R_{DC}	6.4	7.4	8.5			k Ω	$T_A = 25^\circ\text{C}$
Output square-wave voltage swing (pin 5 to pin 2)	$V_{O\ 5,2}$		$V_{7,2}$ -3				V	$T_A = 25^\circ\text{C}$
Short-circuit output current (peak-to-peak) ¹⁾	$I_{5,2}$ or $I_{5,7}$		± 35				mA	$V_{7,2} = 20\ \text{V}$ $T_A = 25^\circ\text{C}$
Tone frequency temperature coefficient	TC		8×10^{-4}				K ⁻¹	

1) An internal resistor of 500 Ω is connected before the output

2) Pin 4 open

Pin 3 grounded or $C \geq 10\ \text{nF}$

Operating Range

Parameter	Symbol	Common Limit Values		PSB 6520-2 Limit Values		PSB 6521-2 Limit Values		PSB 6523-T* Limit Values		Unit
		min.	max.	min.	max.	min.	max.	min.	max.	
Ringing voltage for application circuit figure 3 $f = 50$ Hz test circuit continuous operation 5 s operation/ 10 s pause	$V_{ab \text{ rms}}$		90							V
			110							V
Tone frequency $R_T = 16 \text{ k}\Omega$	f_{1T}			1615	1785	1062	1174	1062	1174	Hz
								1164	1287	
								969	1073	
								1280	1416	
Tone frequency range		0.1	15							kHz
Tone frequency ratio $R_T = 16 \text{ k}\Omega$	$f_{1T}:f_{2T}$			1.35	1.41	1.225	1.275	1.225	1.275	
Switching frequency $C_S = 100 \text{ nF}$	f_s	5.25	9.75							Hz
Switching frequency range		2	50							Hz
Input impedance $f \leq 20 \text{ kHz}$ $V_{1,8 \text{ rms}} \leq 1.3 \text{ V}$	$Z_{1,8}$	100								$\text{k}\Omega$

* Four colour coded frequency groups

Characteristic Curves

Figure 4
Current consumption I_{DC} versus supply voltage V_{DC} without output load

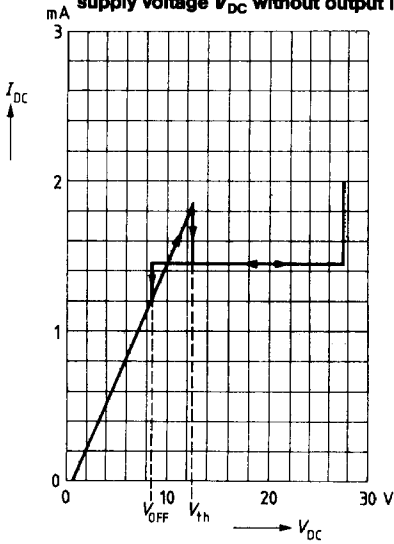

Figure 5
Output current amplitude I_{OUT} versus supply voltage V_{DC} in case of short circuit

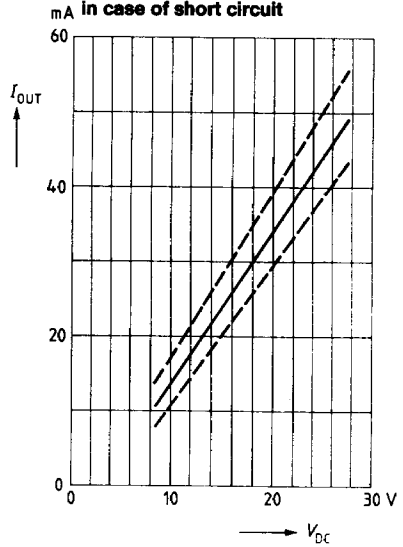

Figure 6
Output power P_{OUT} versus load resistance R_{OUT}

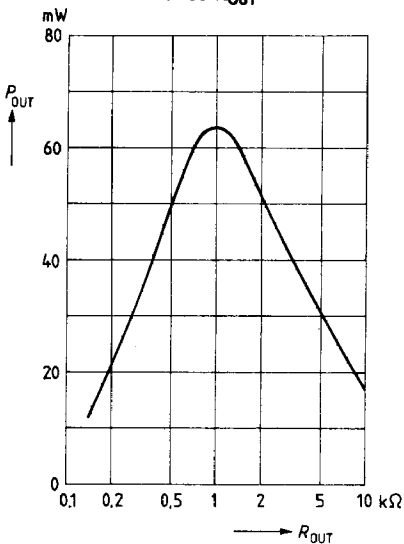
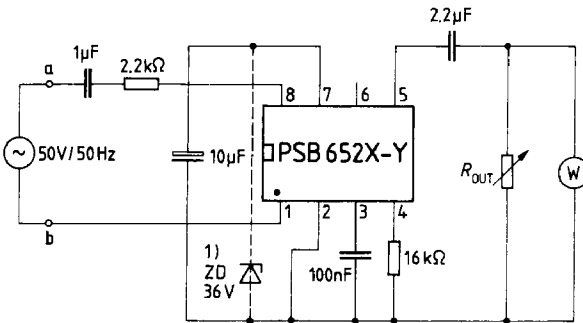

Figure 6.1

Test Circuit to Determine Output Power at Different Load Resistance



1) external Z-diode necessary : PSB 6523-T

Figure 7.1

Test Circuit to Determine Output Power for Variable Call Voltage V_{ab}

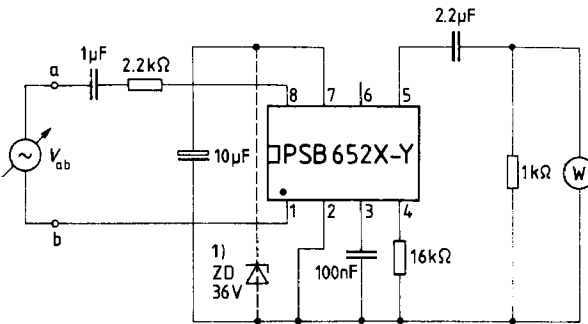

1) external Z-diode necessary : PSB 6523-T

Figure 7
Output power P_{OUT} versus call voltage V_{ab} for power matching

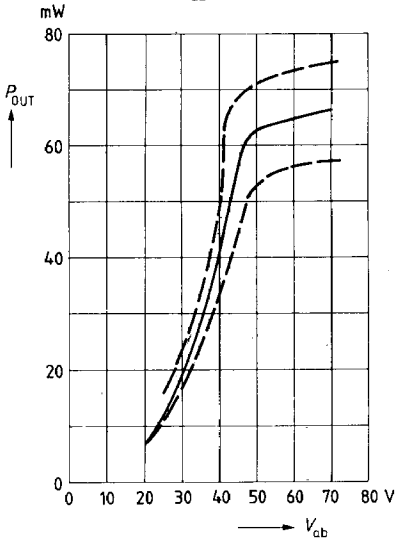

Figure 8
RMS output resistance $R_{OUT\ rms}$ versus call voltage V_{ab}

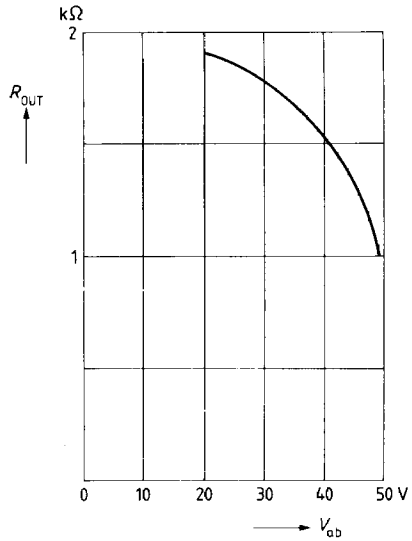
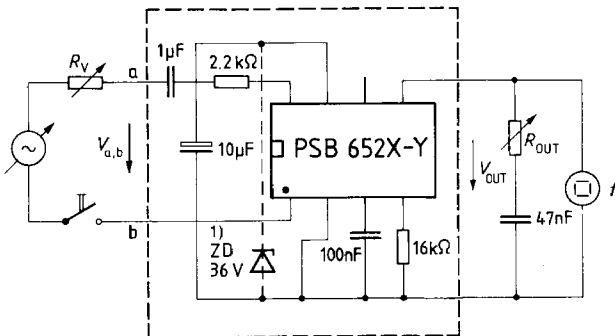

Figure 9
Test Circuit to Determine Delay Times



1) external Z-diode necessary: PSB 6523-T

Figure 9.1

Delay Times

Dependence of delay times t_{ON} , t_{OFF} on V_{ab}

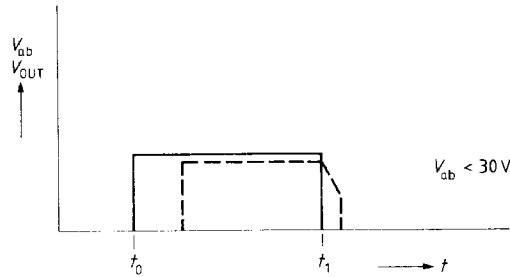
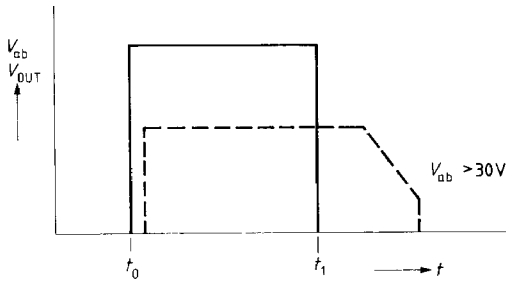
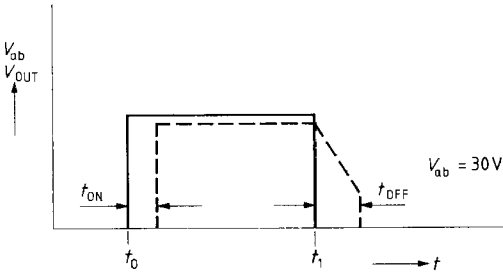

- Effective value of input signal (call voltage V_{ab})
- - - - - Effective value of output signal (output voltage V_{OUT})
- $t_1 - t_0$ Time duration of applied call voltage V_{ab}

Figure 10

Turn-on delay time t_{on} versus V_{ab}
(independent of R_{OUT})

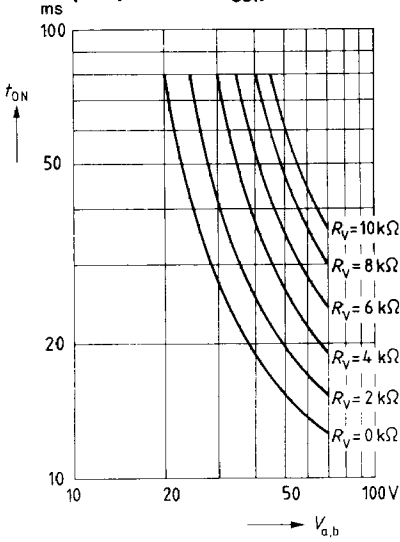

Figure 11

Turn-off delay time t_{off} versus V_{ab}
(independent of R_V)

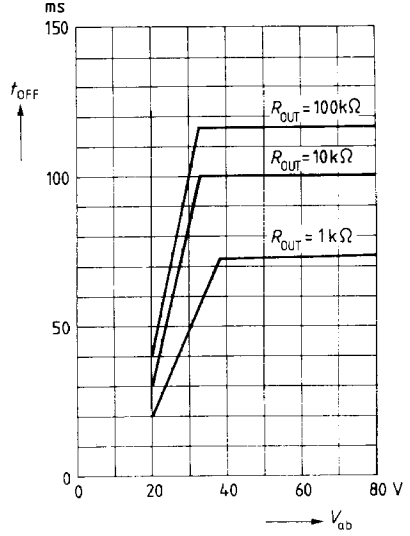

Figure 12

PSB 6520-2

Frequencies f_{1T} and f_{2T}
versus resistance R_T

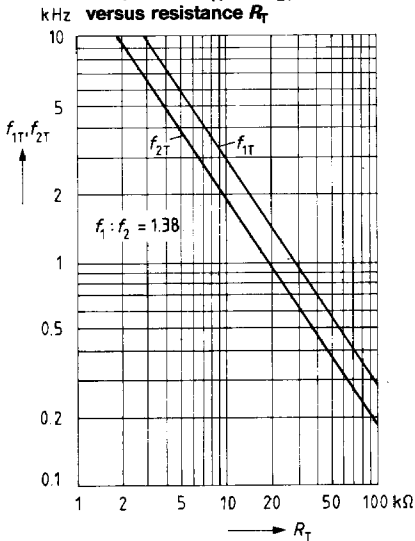

Figure 12.1

PSB 6521-2

PSB 6523-T

Frequencies f_{1T} and f_{2T}
versus resistance R_T

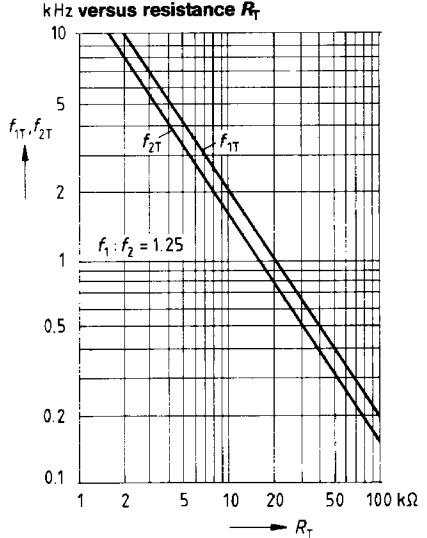

Figure 13

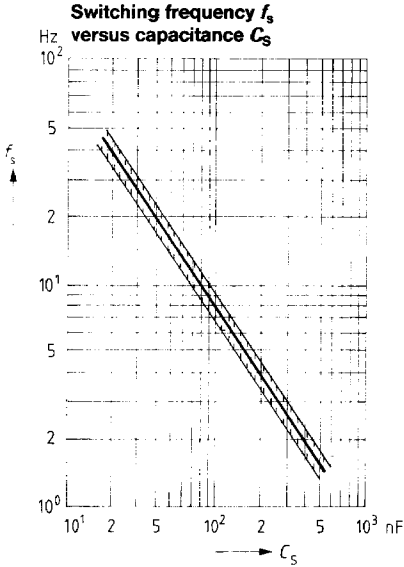
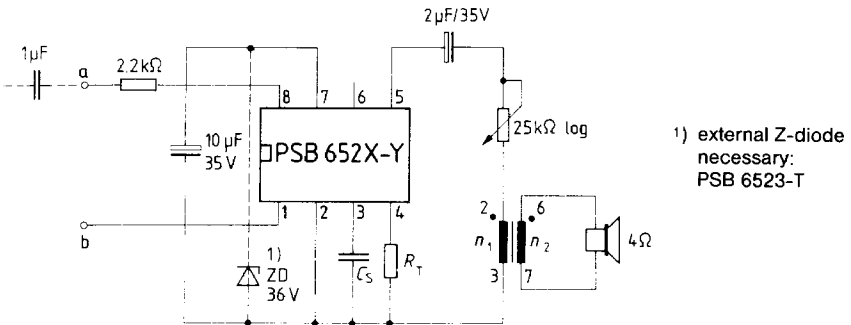

Figure 14

Recommended Circuitry of Matching a 4 Ω Loudspeaker to the PSB 652X Output (example)



Transformer

(18 x 11)

Material: N 30, $A_L = 5600 \text{ nH/W}^2$

Windings: $n_1 = 800, d_1 = 0.08 \text{ mm CuL}$
 $n_2 = 50, d_2 = 0.4 \text{ mm CuL}$