

LGA Packaged Phase Shifter for PCS Base Stations



PS196-315

Features

- Designed for PCS 1960 ± 30 MHz Band
- 100 Degree Phase Shift Range
- 1.5 Degree Phase Deviation
- 0.3 dB Insertion Loss Deviation
- 0–12 V Control Voltage Range
- Specified 33 dBm IP3
- Small Footprint LGA Package

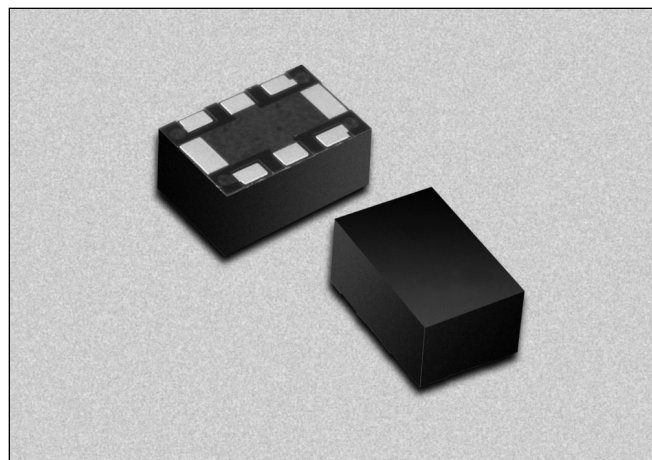

Description

The PS196-315 is a voltage controlled phase shifter specifically designed for use in power amplifier distortion compensation circuits centered at 1960 MHz in PCS band base stations. Its characteristics are specified in a 60 MHz bandwidth. The PS196-315 employs a monolithic quadrature hybrid and a pair of selected silicon varactor diodes to achieve 100-degree phase shift and low insertion loss. The PS196-315 is packaged in the small outline LGA (Land Grid Array) surface mount package with the internal elements affixed to an organic BT substrate.

Electrical Specifications at 25°C

Parameter	Condition	Min.	Typ.	Max.	Unit
Frequency Range (BW)	$F_O = 1946$	1916		1976	MHz
Phase Shift	At F_O , $C_V = 12$ V	100			Deg.
Phase Deviation in BW	$C_V = 0-12$ V		1.5	2.0	Deg.
Control Voltage (C_V) Range		0		12	V
Control Current	$C_V = 12$ V			1	μ A
Insertion Loss in BW	($C_V = 0$ V)			2.3	dB
I.L. Deviation in BW	$C_V = 0-12$ V			0.3	dB
I.L. Variation	At F_O , $C_V = 0-12$ V			0.75	dB
VSWR in BW				1.8	
IM3	$P_{IN} = 8$ dBm, 1900/1905 MHz, $C_V = 0$ V			-50	dBc
IP3	Derived from IM3	33			dBm

Typical Performance Data

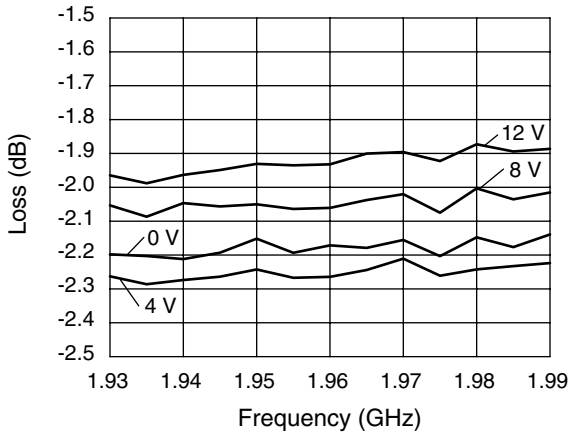

Insertion Loss vs. Frequency and Control Voltage

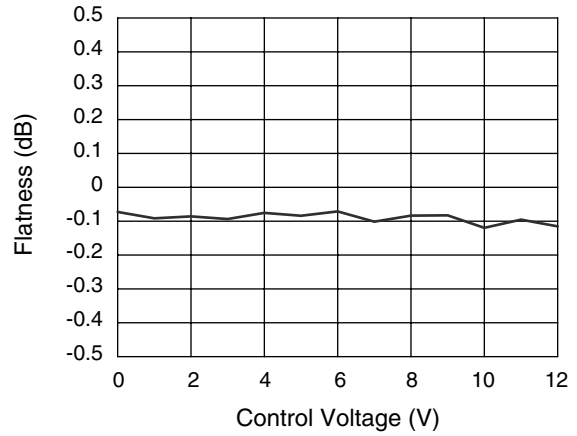

Insertion Loss Flatness vs. Control Voltage

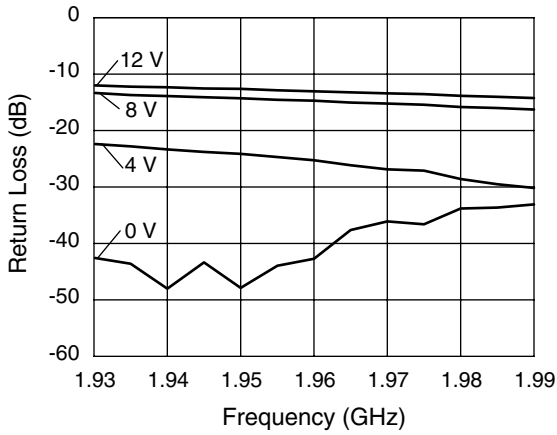

Input/Output Return Loss vs. Frequency and Control Voltage

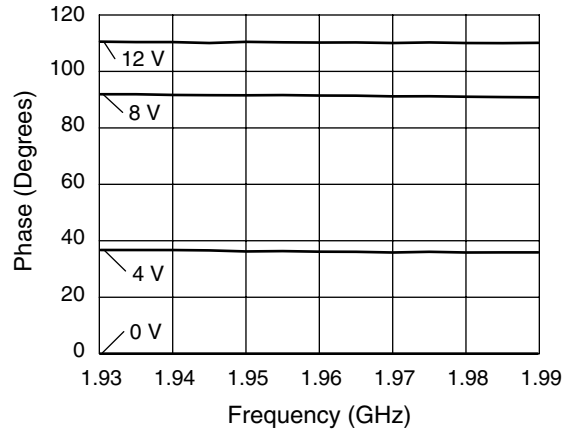

Phase vs. Frequency and Control Voltage

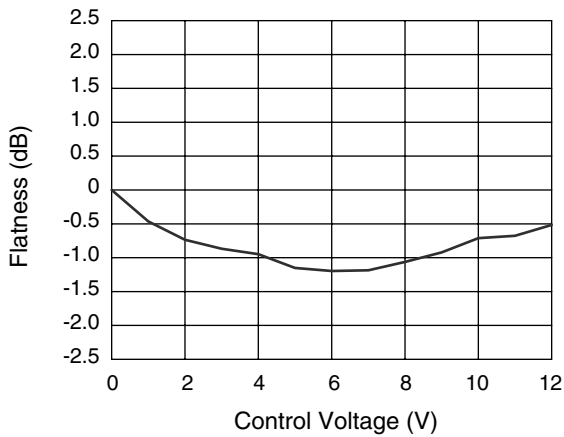

Phase Flatness vs. Control Voltage

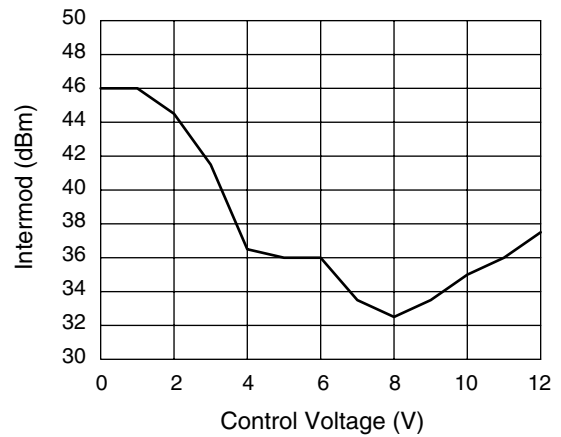

**3rd Order Intermod vs. Control Voltage
RF₁ = 1.900 GHz, RF₂ = 1.905 GHz @ 8 dBm**

Pin Out (Bottom View)

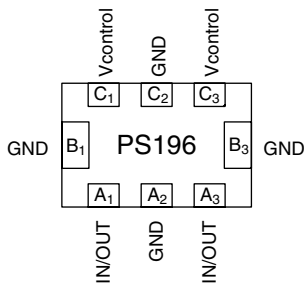

Connection Diagram

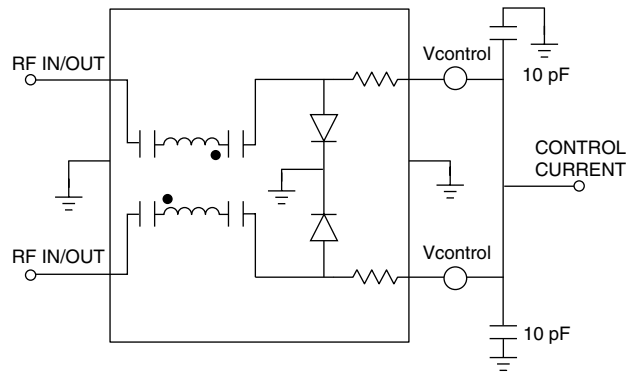

Terminal No.	Terminal Name
A ₁	IN/OUT
A ₂	GND
A ₃	IN/OUT
B ₁	GND
B ₃	GND
C ₁	Vcontrol
C ₂	GND
C ₃	Vcontrol

-315

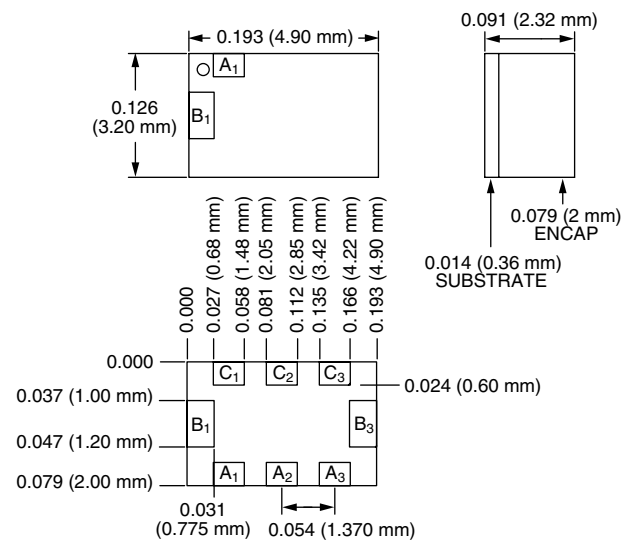

Absolute Maximum Ratings

Characteristic	Value
RF Input Power	20 dBm
Control Voltage	15 V
Operating Temperature	-40 to +85°C
Storage Temperature	-40 to +85°C