

PM557BA

P-Channel Enhancement Mode MOSFET

PRODUCT SUMMARY

$V_{(BR)DSS}$	$R_{DS(ON)}$	I_D
-30V	50mΩ @ $V_{GS} = -4.5V$	-3.3A

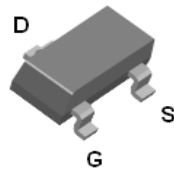

SOT-23(S)

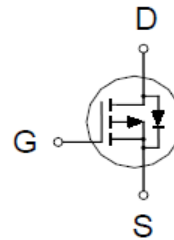

ABSOLUTE MAXIMUM RATINGS ($T_A = 25\text{ }^\circ\text{C}$ Unless Otherwise Noted)

PARAMETERS/TEST CONDITIONS		SYMBOL	LIMITS	UNITS
Gate-Source Voltage		V_{GS}	± 12	V
Continuous Drain Current	$T_A = 25\text{ }^\circ\text{C}$	I_D	-3.3	A
	$T_A = 70\text{ }^\circ\text{C}$		-2.6	
Pulsed Drain Current ¹		I_{DM}	-16	
Power Dissipation	$T_A = 25\text{ }^\circ\text{C}$	P_D	0.9	W
	$T_A = 70\text{ }^\circ\text{C}$		0.6	
Operating Junction & Storage Temperature Range		T_j, T_{stg}	-55 to 150	$^\circ\text{C}$

THERMAL RESISTANCE RATINGS

THERMAL RESISTANCE	SYMBOL	TYPICAL	MAXIMUM	UNITS
Junction-to-Ambient ²	$R_{\theta JA}$		130	$^\circ\text{C} / \text{W}$

¹Pulse width limited by maximum junction temperature.

²The value of $R_{\theta JA}$ is measured with the device mounted on 1in² FR-4 board with 2oz.Copper.

PM557BA

P-Channel Enhancement Mode MOSFET

ELECTRICAL CHARACTERISTICS (T_J = 25 °C, Unless Otherwise Noted)

PARAMETER	SYMBOL	TEST CONDITIONS	LIMITS			UNITS
			MIN	TYP	MAX	
STATIC						
Drain-Source Breakdown Voltage	V _{(BR)DSS}	V _{GS} = 0V, I _D = -250μA	-30			V
Gate Threshold Voltage	V _{GS(th)}	V _{DS} = V _{GS} , I _D = -250μA	-0.7	-0.9	-1.3	
Gate-Body Leakage	I _{GSS}	V _{DS} = 0V, V _{GS} = ±12V			±100	nA
Zero Gate Voltage Drain Current	I _{DSS}	V _{DS} = -24V, V _{GS} = 0V			-1	μA
		V _{DS} = -20V, V _{GS} = 0V, T _J = 55 °C			-10	
Drain-Source On-State Resistance ¹	R _{DS(ON)}	V _{GS} = -2.5V, I _D = -1A		50	75	mΩ
		V _{GS} = -4.5V, I _D = -3.3A		40	50	
Forward Transconductance ¹	g _{fs}	V _{DS} = -5V, I _D = -3.3A		15		S
DYNAMIC						
Input Capacitance	C _{iss}	V _{GS} = 0V, V _{DS} = -15V, f = 1MHz		807		pF
Output Capacitance	C _{oss}			81		
Reverse Transfer Capacitance	C _{rss}			61		
Total Gate Charge ²	Q _g	V _{DS} = -15V, V _{GS} = -4.5V, I _D = -3.3A		8.6		nC
Gate-Source Charge ²	Q _{gs}			1.1		
Gate-Drain Charge ²	Q _{gd}			2.6		
Turn-On Delay Time ²	t _{d(on)}	V _{DD} = -15V, V _{GS} = -4.5V I _D ≅ -3.3A, R _G = 6Ω		19		nS
Rise Time ²	t _r			30		
Turn-Off Delay Time ²	t _{d(off)}			55		
Fall Time ²	t _f			20		
SOURCE-DRAIN DIODE RATINGS AND CHARACTERISTIC (T_J = 25 °C)						
Continuous Current	I _S				-0.8	A
Forward Voltage ¹	V _{SD}	I _F = -3.3A, V _{GS} = 0V			-1.1	V
Reverse Recovery Time	t _{rr}	I _F = -3.3A, dI _F /dt = 100A / μS		8.5		nS
Reverse Recovery Charge	Q _{rr}				2.5	

¹Pulse test : Pulse Width ≤ 300 μsec, Duty Cycle ≤ 2%.

²Independent of operating temperature.

PM557BA

P-Channel Enhancement Mode MOSFET

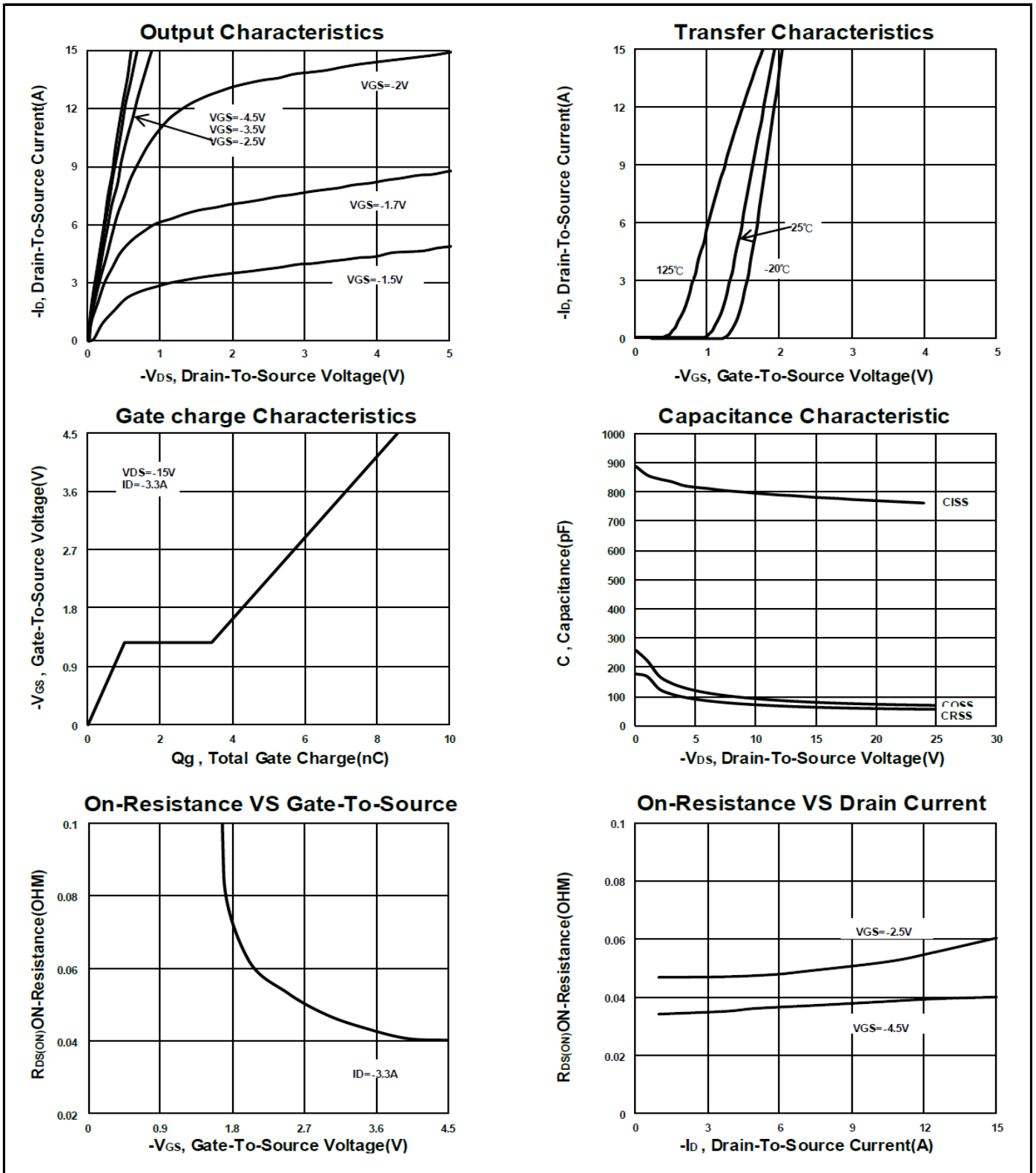

PM557BA

P-Channel Enhancement Mode MOSFET

On-Resistance VS Temperature

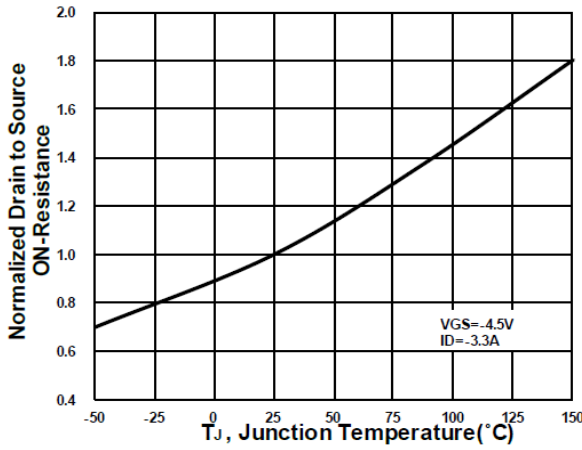

Source-Drain Diode Forward Voltage

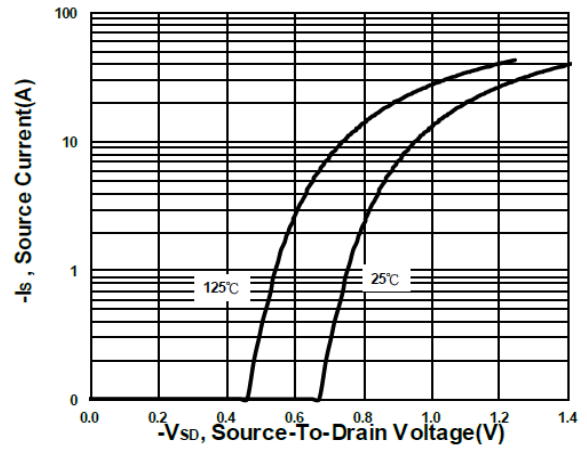

Safe Operating Area

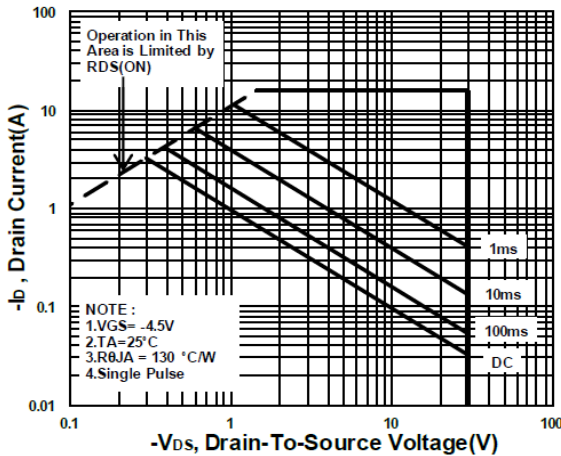

Single Pulse Maximum Power Dissipation

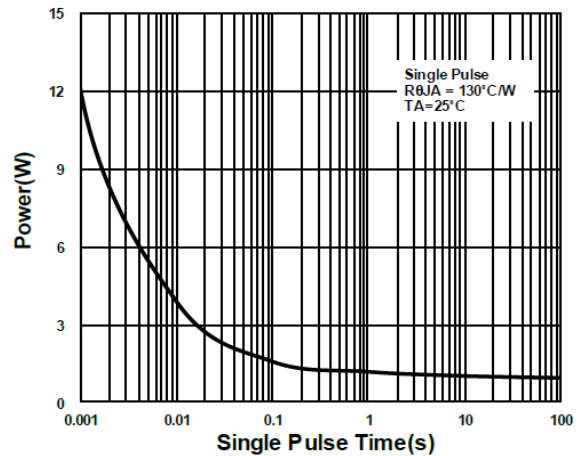

Transient Thermal Response Curve

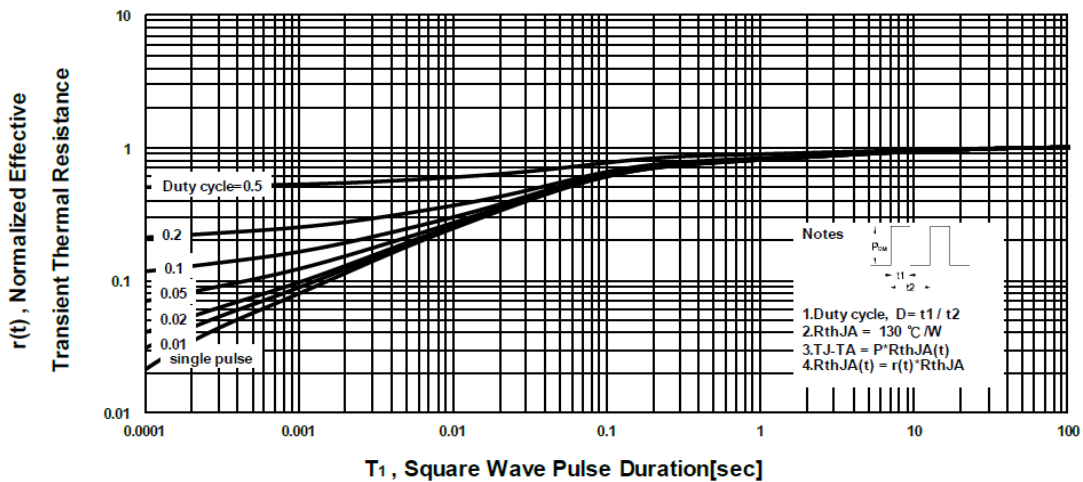

PM557BA

P-Channel Enhancement Mode MOSFET

Package Dimension

SOT-23 (S) MECHANICAL DATA

Dimension	mm			Dimension	mm		
	Min.	Typ.	Max.		Min.	Typ.	Max.
A	0.9		1	H	0.08		0.2
B	2.25		2.85	I	0.15		0.6
C	1.2		1.4				
D	2.8		3.04				
E	0.89		1.2				
F	0		0.1				
G	0.3		0.5				

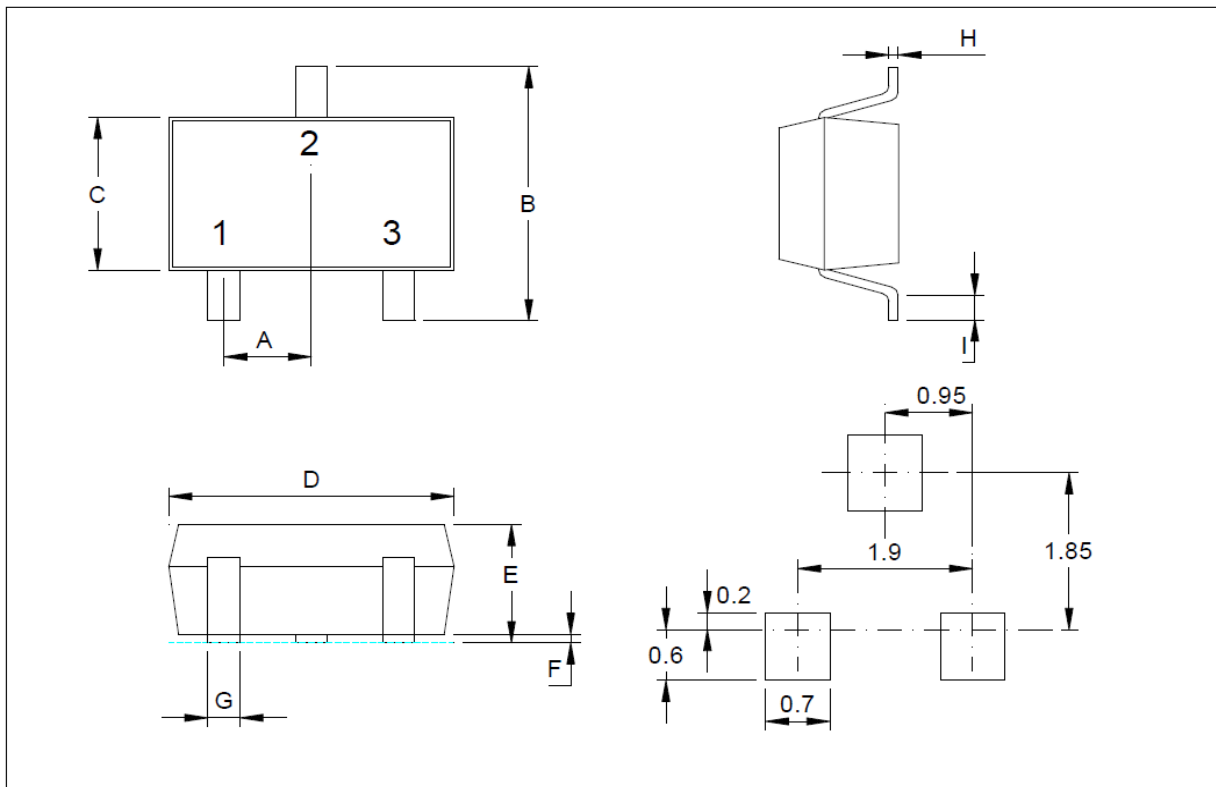

PM557BA

P-Channel Enhancement Mode MOSFET

A. Marking Information (此产品代码为 : 4C)

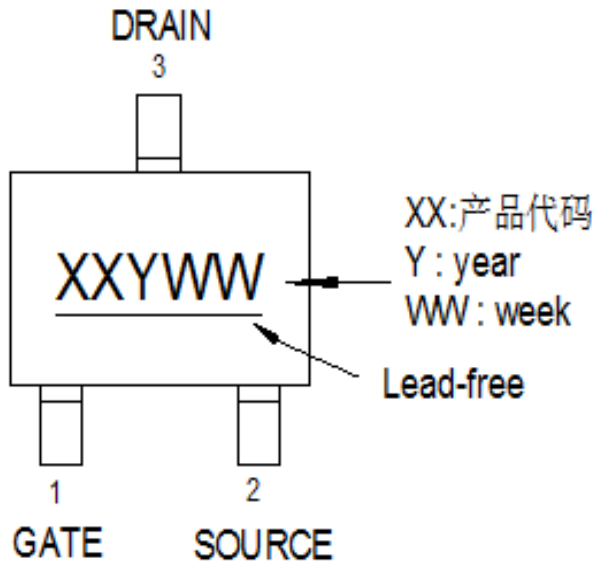

B. Tape&Reel Information:3000pcs/Reel

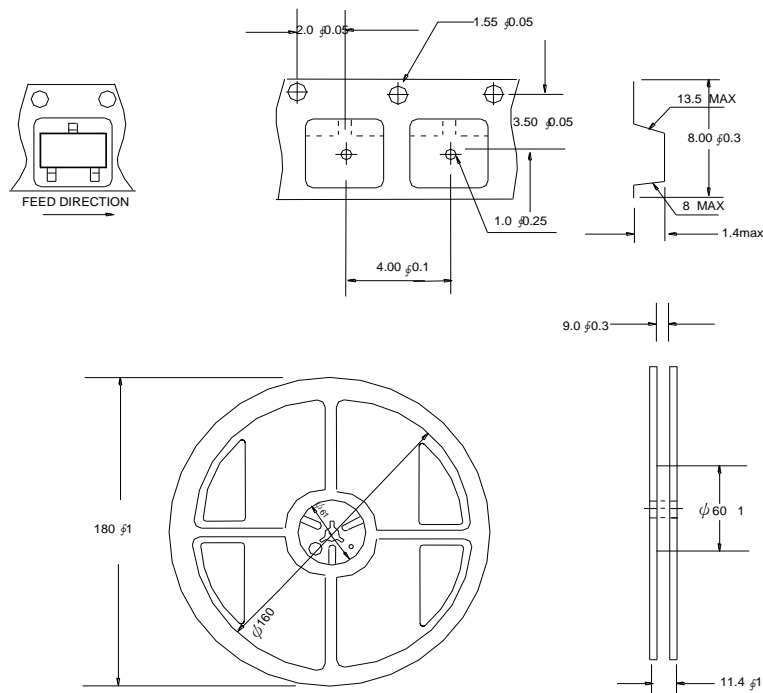

PM557BA

P-Channel Enhancement Mode MOSFET

C. Lot No.&Date Code rule

1.Lot No.

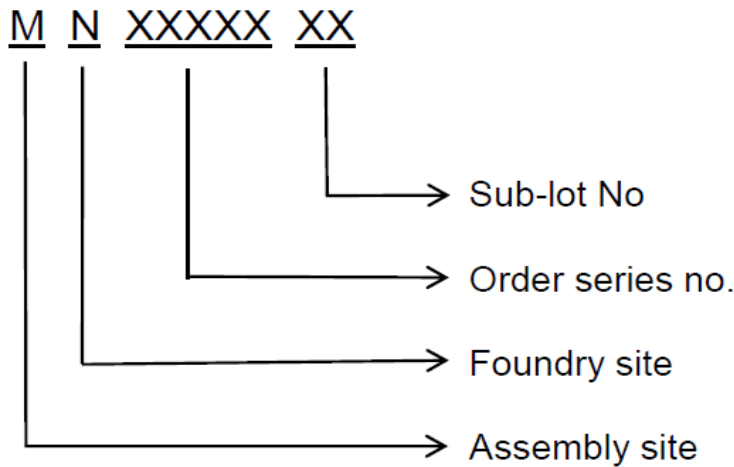

2.Date Code

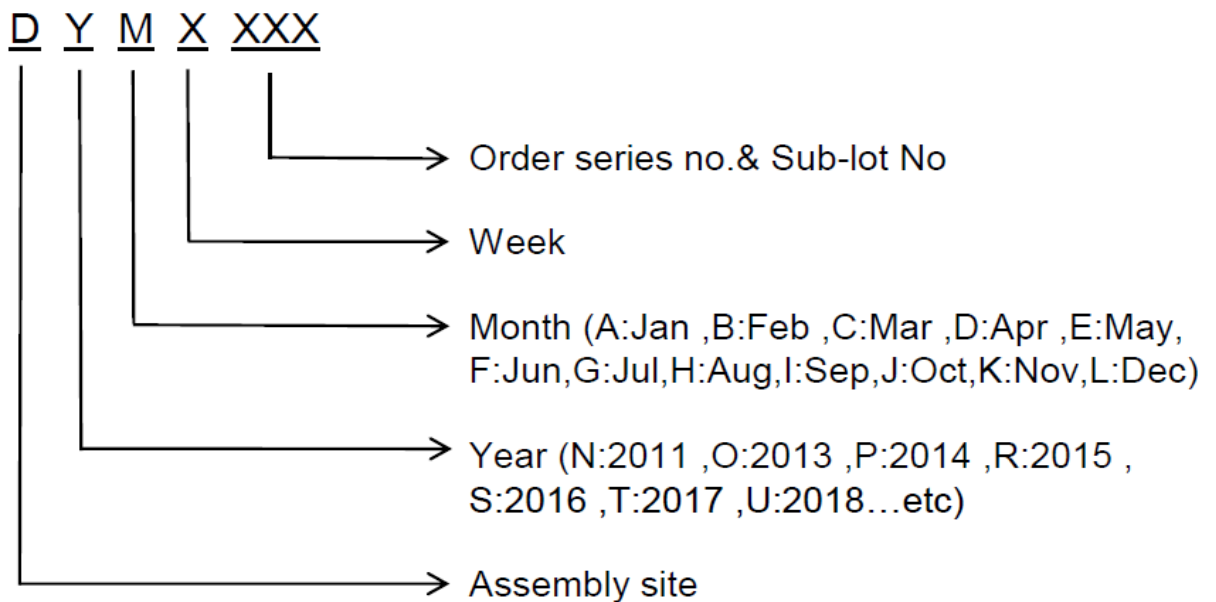



PM557BA

P-Channel Enhancement Mode MOSFET

D.Label rule

标签内容(Label content)



1	Label Size	30 * 90 mm
2	Font style	Times New Roman or Arial (或可区分英文"0"和数字"0", "G"和"Q"的字型即可)
3	U-NIKC	Height: 4 mm
4	Package	Height: 2 mm
5	Date	Height: 2 mm Shipping date: YYYY/MM/DD, ex. 2008/09/12
6	Device	Height: 3 mm (Max: 16 Digit)
7	Lot	Height: 3 mm (Max: 9 Digit) Sub lot
8	D/C	Height: 3 mm (Max: 7 Digit)
9	QTY	Height: 3 mm (Max: 6 Digit) Thousand mark is no needed
10	RoHS label	 long axis: 12 mm minor axis: 6 mm bottom color: White Font color: Black Font style: Arial
11	Halogen Free label	 Diameter: 10 mm bottom color: Green Font color: Black Font style: Arial
12	Scan information	Device / Lot / D/C / QTY , Insert " / " between every parts. for example: P3055LDG/G12345601/GGG2301/2000 DPI (Dots per inch): Over 300 dpi Code : Code 128 Height: 6 mm at least