

## AT-Cut Crystal - Square Wave - 5.0 Volts

- Frequency Range 5.0MHz to 20.0MHz
- 50.8 x 50.8 x 16.0mm 7 pin metal, solder-sealed package
- Supply Voltage 5.0 Volts
- AT-Cut Crystal
- Squarewave Output
- EFC (Voltage control) as standard

### DESCRIPTION

OC22T5A series oven-controlled crystal oscillators are close tolerance OCXOs with good phase noise performance.

### SPECIFICATION

Crystal Cut:	AT-cut
Output Waveform:	Square Wave
Supply Voltage:	+5.0 VDC $\pm 0.2V$
Frequency Range:	5.0MHz to 20.0MHz
Initial Calibration Tolerance:	$\pm 0.1$ ppm max.(at $V_{CON} + 2.5V$ )
Frequency Stability	
over 0° to +60°C:	$\pm 0.05$ ppm
over -20° to +70°C:	$\pm 0.1$ ppm
over -40° to +85°C:	$\pm 0.2$ ppm
vs. Voltage Change:	$< \pm 1.0$ ppb for $\pm 5\%$ change
vs. Ageing:	$\pm 3.0$ ppb max per day $\pm 0.5$ ppm per first year $\pm 3.0$ ppm over 10 years
vs. Load Change:	$< \pm 1.0$ ppb for $\pm 5\%$ change

Warm-up Time: 1 minutes max. to within  $\pm 0.2$ ppm of nominal freq.

### Voltage Control

Control Voltage Centre:	+2.5 Volts ( $V_{CON}$ )
Freq. Deviation Range:	$\pm 5.0$ ppm min., $\pm 20$ ppm max. ref. to 25°C and O.T.R.
Control Voltage Range:	2.5V $\pm 2.0$ Volts
Transfer Function:	Positive: Increasing control voltage increases output frequency
Input Impedance:	100k $\Omega$ minimum
EFC Linearity:	$\pm 10\%$ maximum

Power Dissipation: 2.0W max. steady state  
6.0W max. at turn on

### Output

Load:	15pF HCMOS
Output Logic HIGH:	+4.5V minimum
Output Logic LOW:	0.5V maximum
Duty Cycle:	50% $\pm 10\%$
Rise/Fall Time:	5ns max (20%~80%) Frequency dependant

Reference Voltage: +4.0  $\pm 0.3$ VDC or custom

### Environmental

Storage Temperature:	-55° to +125°C
Shock:	2000g, 0.3ms $\frac{1}{2}$ sine
Vibration:	10 ~2000Hz / 10g

### PHASE NOISE (at 10MHz)

Offset	dBc/Hz
1Hz	-75
10Hz	-100
100Hz	-130
1kHz	-140
10kHz	-150

### OUTLINE & DIMENSIONS

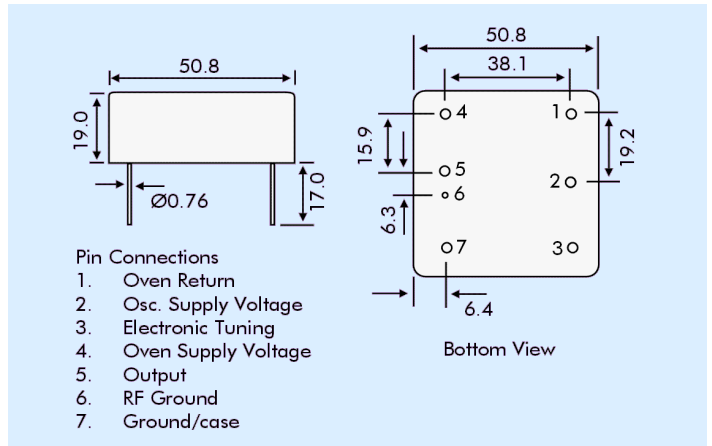

### TEST CIRCUIT

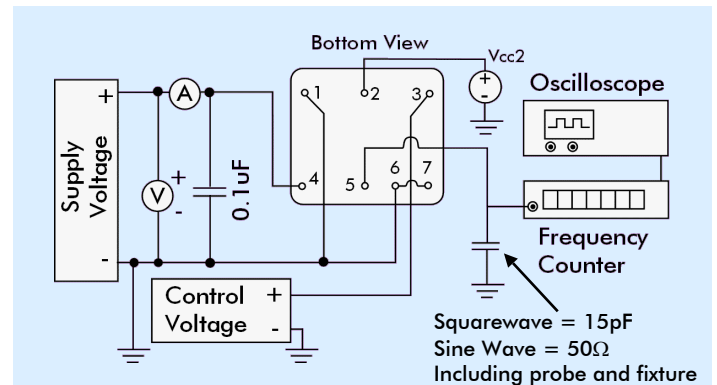

### PART NUMBER FORMAT

Example: **OC22GT5A-10.000-0.10/-20+70**

