

H530VI (TFT-LCD) PROJECT

Scaler : MSCOT V (ADC 포함)
MICOM : Novatek, NT68F63L
RESOLUTION : 1024 X 768 (MAX)
REFRESH RATE : 75Hz (MAX)
DOT CLK : 100MHz (MAX)
REVISION : 01 (TTL TYPE)

REV.	CONTENT	LOCATION	DATE

DRAWN	S . H . CHOI
CHECKED	S . H . PARK
APPROVAL	S . H . CHUNG

Title		H530VI	
Size	Document Number	Rev	
A3	012205XXXXCA	01	
Date	Thursday, May 09, 2001	Sheet	0 of 7

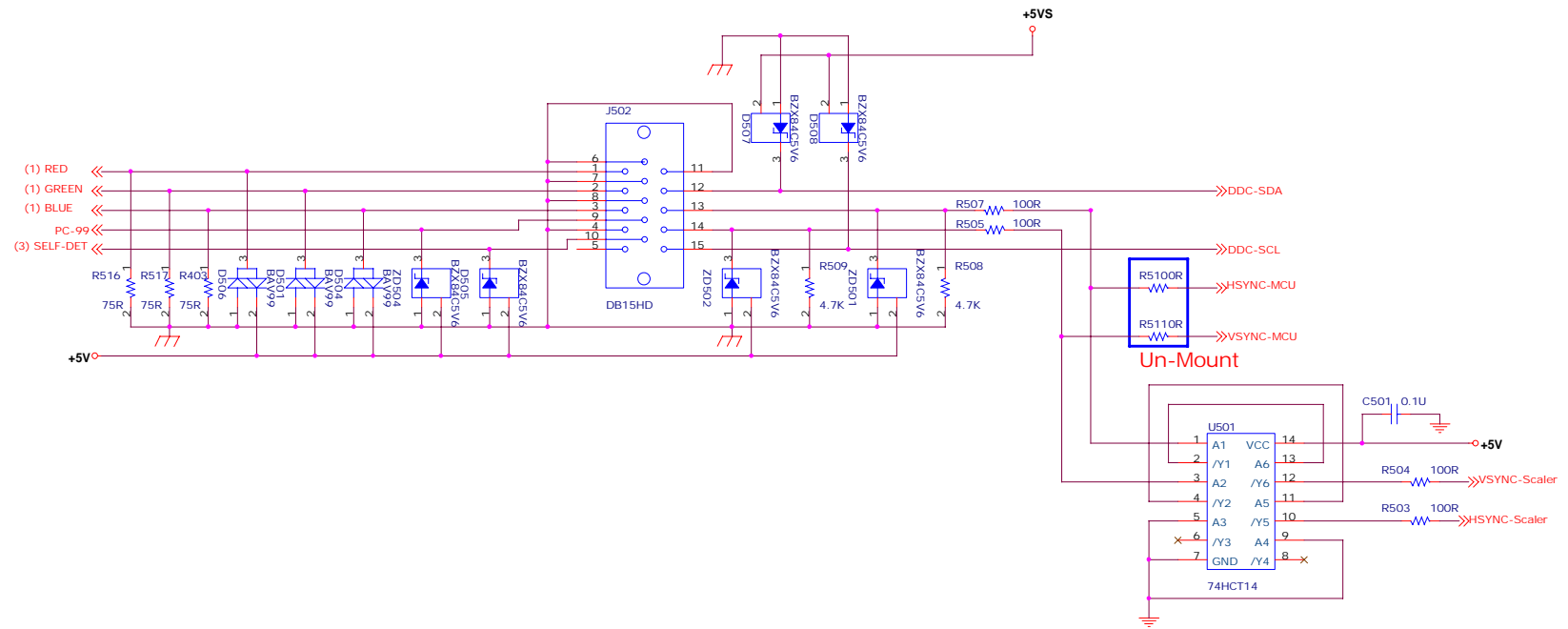

VGA INPUT		
File	Hansol H530V1	
Size	Document Number	Rev
A3	012205XXXXCA	01
Date	Thursday, May 09, 2002	Sheet 1 of 1

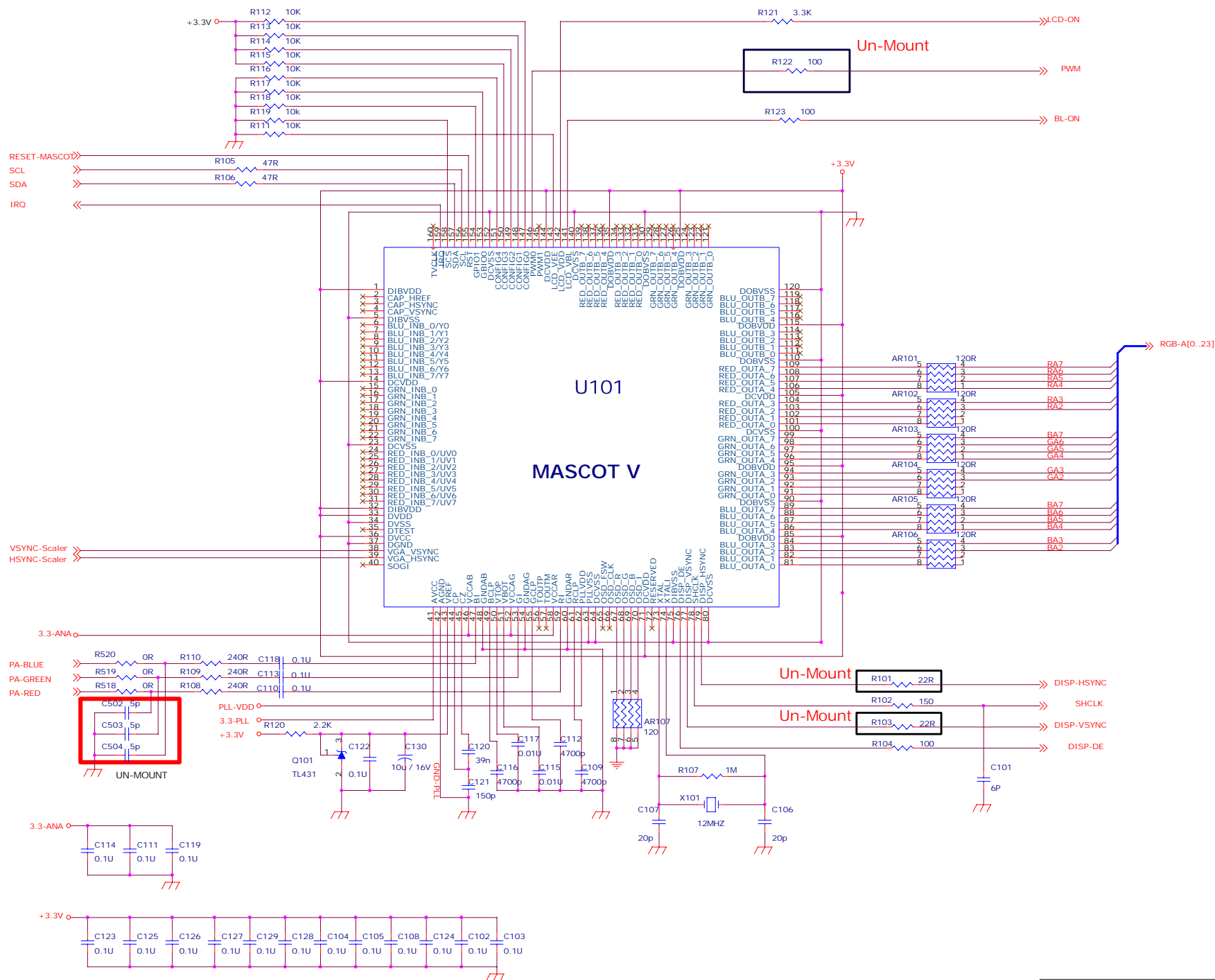

SCALER(MRT MASCOT V)		
Title Hansol H530VI		
Size A3	Document Number 012205XXXXCA	Rev 01
Date Thursday, May 09, 2002	Sheet 2 of 6	

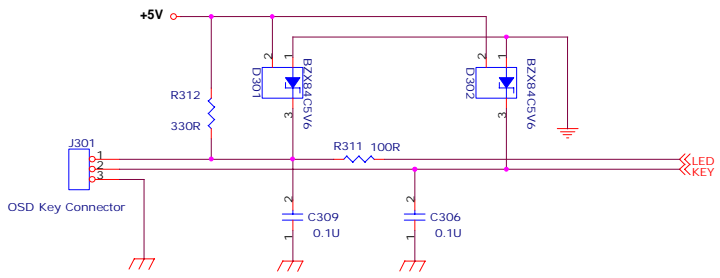
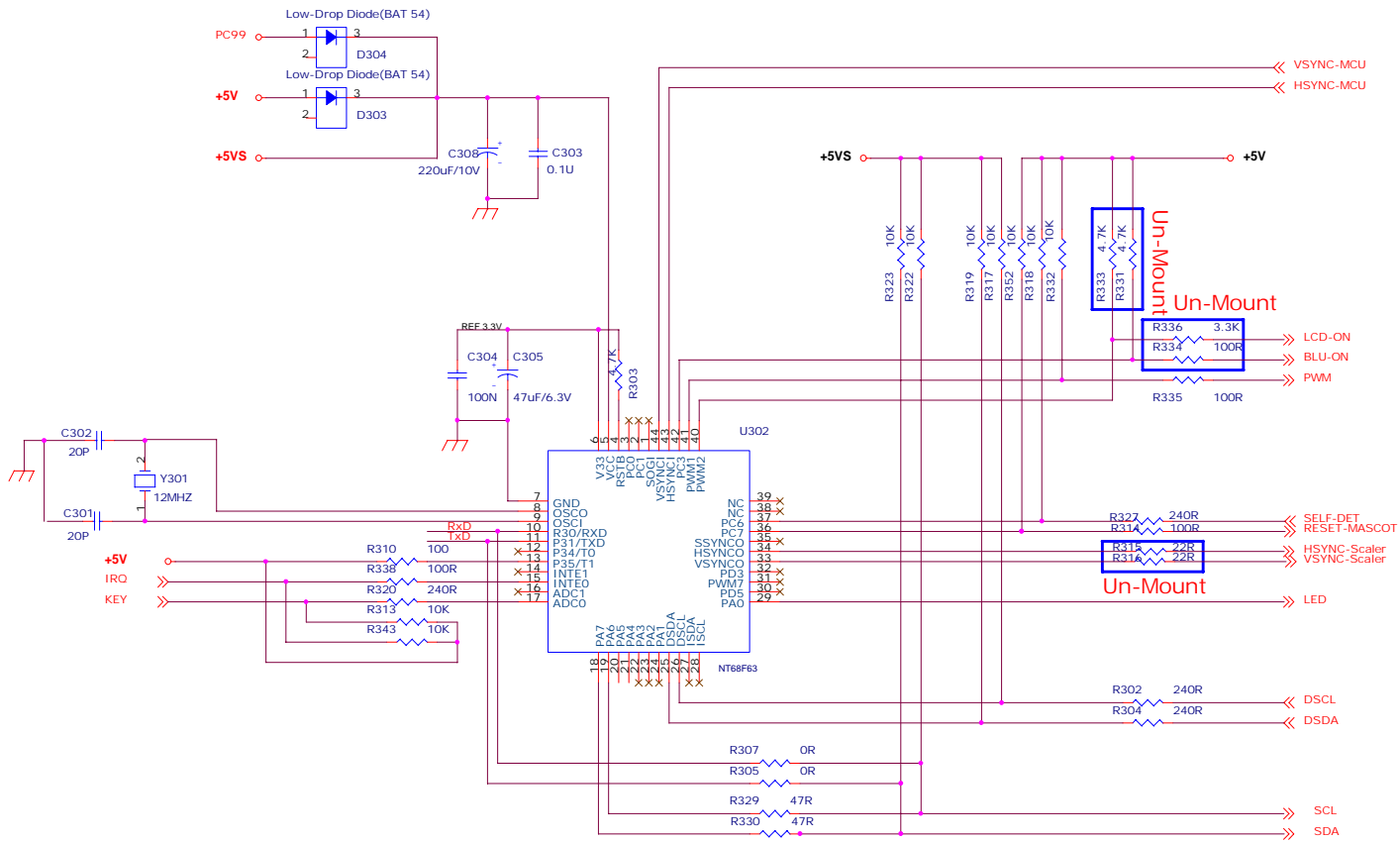

Debug-Connector

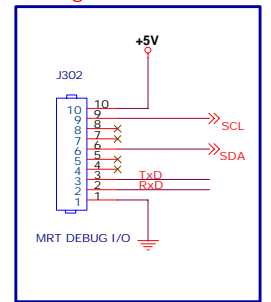

Un-Mount

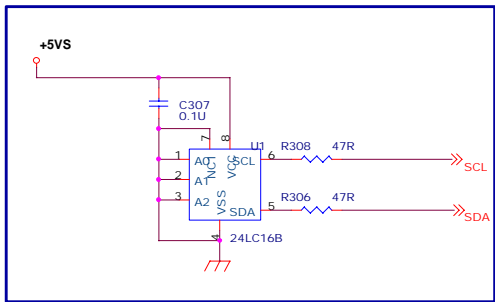

Un-Mount

MICOM(NOVATEK NT68F63L)		
title	Hansol H530VI	
Size	Document Number	Rev
A3	012205XXXXCA	01
Date: Thursday, May 09, 2002	Sheet	3 of 6

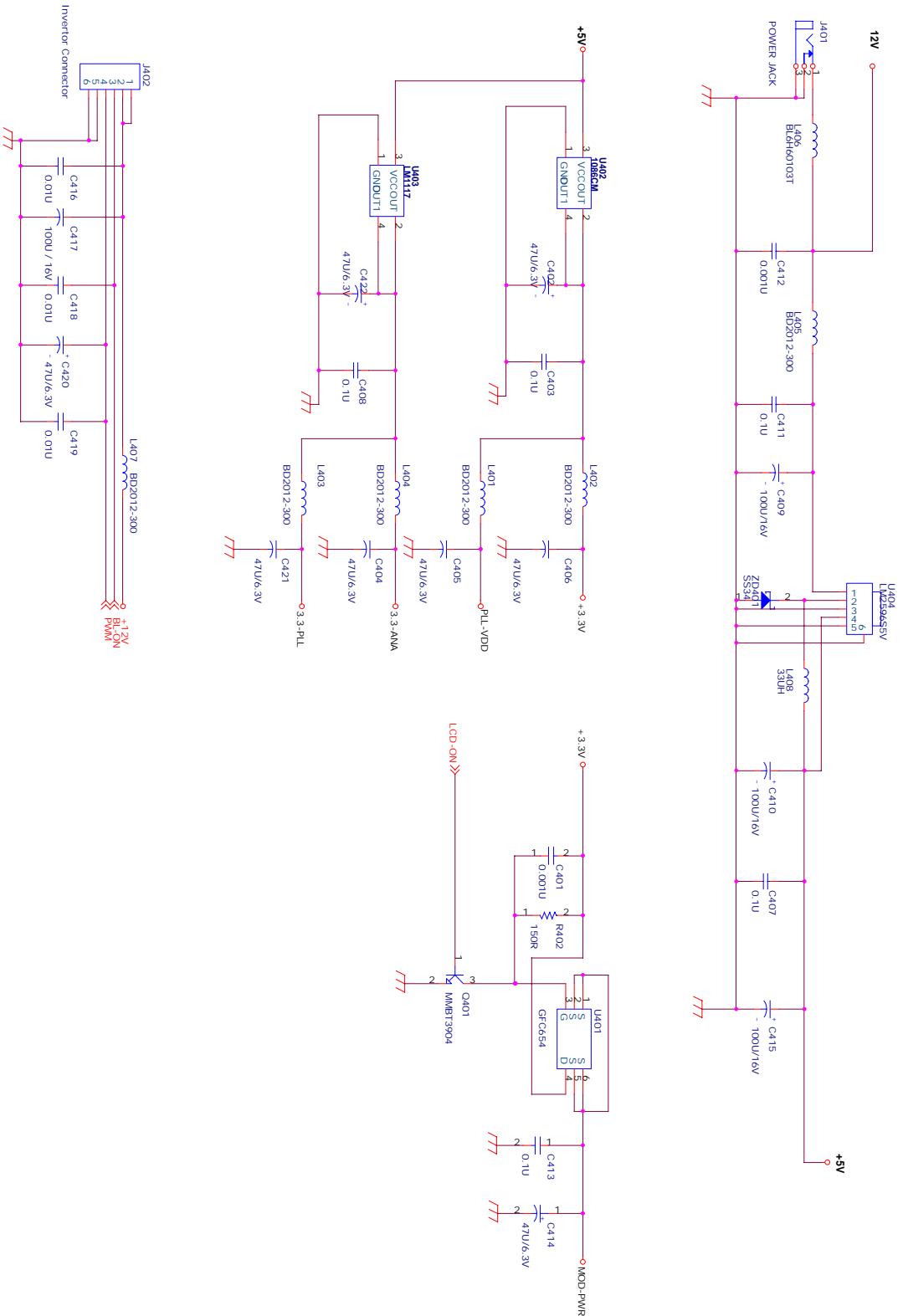

POWER LINE

Title	Hansol H530V1
Document Number	012205XXXXCA
Size	A3
File	Thurseday_May_09_2002
Sheet	4 of 6
Rev	01

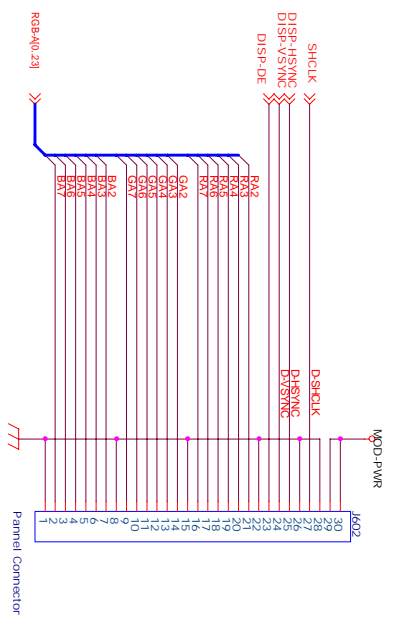

PANEL INTERFACE			
Part	Hansol HS30VI		
Rev	Revision Number	Rev	
A3	012205XXXXCA	01	
Date	Thursday, May, 09, 2002	Sheet	5 of 4

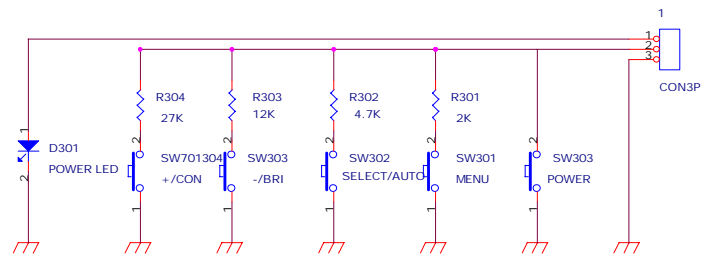

OSD KEY		
Title		
Hansol H530VI		
Size	Document Number	Rev
A3	012205XXXXCA	01
Date:	Thursday, May 09, 2002	Sheet 1 of 6