



Audio Processor with Sound Enhancement and TruSurround Virtualizer

■ GENERAL DESCRIPTION

The NJW1148 is an audio processor with BBE sound enhancement and SRS Labs' TruSurround virtualizer. It includes all of functions processing audio signal for TV, such as volume, balance, mute, line out, tone control, eala NJRC surround and simulated stereo functions. All of internal status and variables are controlled by I²C BUS.

■ PACKAGE OUTLINE

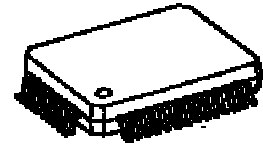

NJW1148FP1

■ FEATURES

- Operating Voltage 8 to 10 V
- I²C BUS Interface (Fast-Mode)
- Passive TruSurround
- BBE 0dB to +15dB(0.5dB/step)
- eala (surround effect ; 2 steps) and Simulated Stereo
- Volume 0 to -80dB, MUTE(0.33dB/step)
- Balance 0 to -30dB, MUTE(1dB/step)
- Tone Control -15dB to +15dB(0.5dB/step)
- Bi-CMOS Technology
- Package Outline QFP48-P1

■ BLOCK DIAGRAM

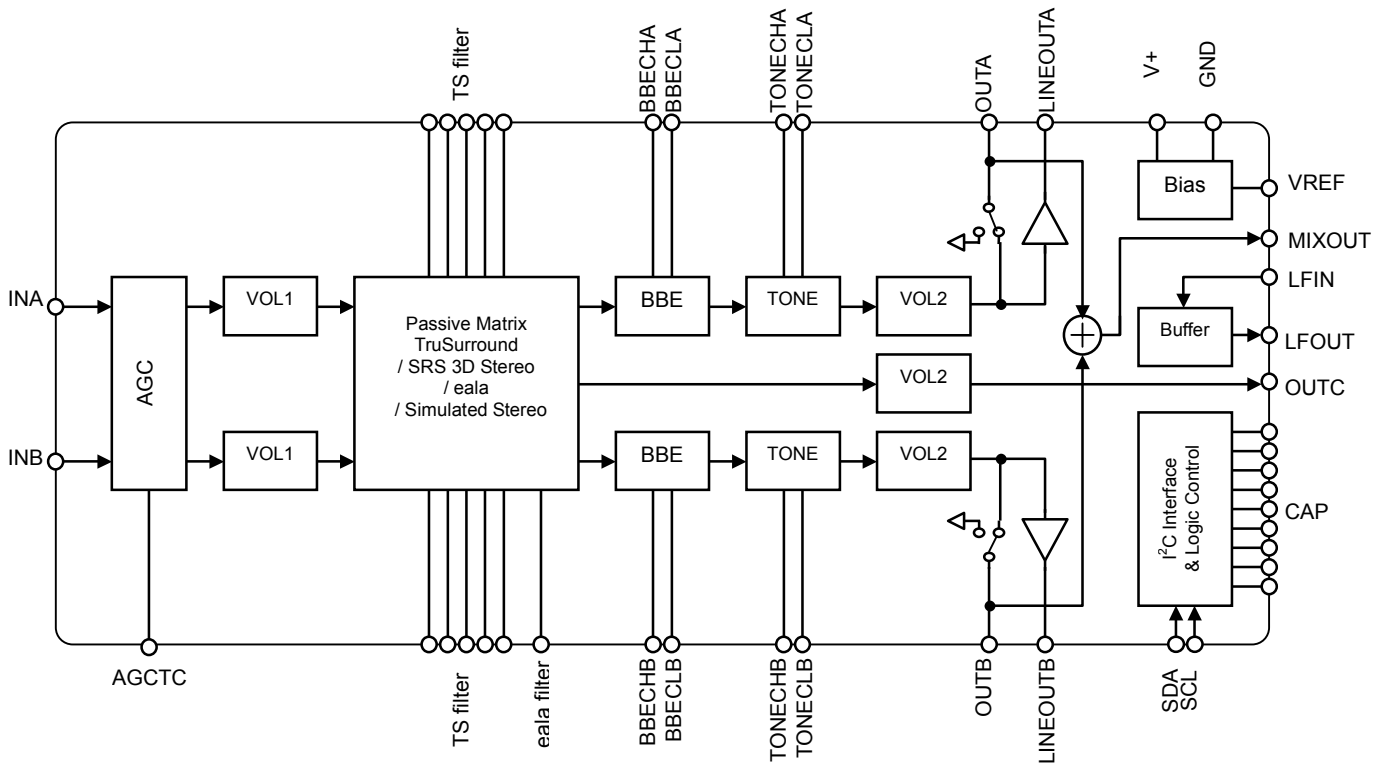

■ PIN FUNCTION

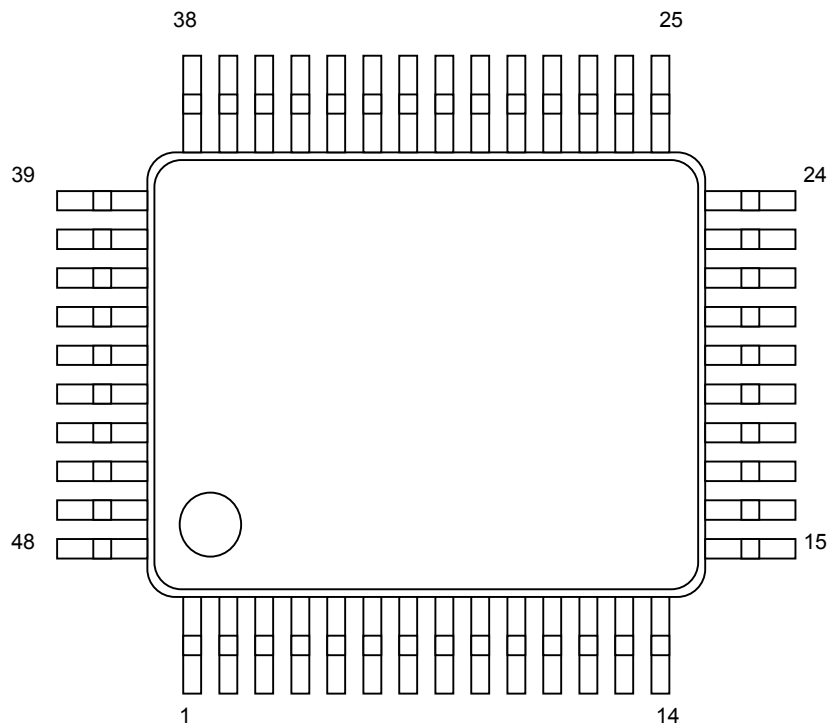

No.	SYMBOL	FUNCTION	No.	SYMBOL	FUNCTION
1	TS3	TruSurround Filter Capacitor 3	25	BBELTC	BBE Low switching noise rejection Capacitor
2	INA	Ach Input	26	BBEHTC	BBE High switching noise rejection Capacitor
3	BBECHA	Ach BBE High-Pass Filter Capacitor	27	N.C.	No Connection
4	BBECLA	Ach BBE Low-Pass Filter Capacitor	28	LFOUT	Buffer Output for LPF
5	TONECHA	Ach TONE Treble Filter Capacitor	29	LFIN	Buffer Input for LPF
6	TONECLA	Ach TONE Bass Filter Capacitor	30	MIXOUT	Ach Bch Mixed Output
7	LINEOUTA	Ach Line Output	31	OUTB	Bch Output
8	OUTA	Ach Output	32	LINEOUTB	Bch Line Output
9	OUTC	Center Output	33	TONECLB	Bch TONE Bass Filter Capacitor
10	N.C.	No Connection	34	TONECHB	Bch TONE Treble Filter Capacitor
11	AGCTC	AGC Smoothing Filter Capacitor	35	BBECLB	Bch BBE Low-Pass Filter Capacitor
12	SURTC	Surround switching noise rejection Capacitor	36	BBECHB	Bch BBE High-Pass Filter Capacitor
13	VOLATC	Ach Volume switching noise rejection Capacitor	37	INB	Bch Input
14	VOLBTC	Bch Volume switching noise rejection Capacitor	38	SRS4	SRS Filter Capacitor 4
15	VOLCTC	Center Volume switching noise rejection Capacitor	39	SRS3	SRS Filter Capacitor 3
16	SDA	I ² C Data Input	40	SRS2	SRS Filter Capacitor 2
17	SCL	I ² C Clock Input	41	SRS1	SRS Filter Capacitor 1
18	GND	Ground	42	SPACE1	SPACE Volume1
19	N.C.	No Connection	43	CENTER	CENTER Volume
20	V+	Power Supply	44	N.C.	No Connection
21	VREF	Reference Voltage stabilizing Capacitor	45	SPACE2	SPACE Volume2
22	TONEHTC	Tone Control Treble switching noise rejection Capacitor	46	CEALA	eala Filter Capacitor
23	TONELTC	Tone Control Bass switching noise rejection Capacitor	47	TS1	TruSurround Filter Capacitor 1
24	OUTTC	Line Output switching noise rejection Capacitor	48	TS2	TruSurround Filter Capacitor 2

■ ABSOLUTE MAXIMUM RATING (Ta=25°C)

PARAMETER	SYMBOL	RATING	UNIT
Supply Voltage	V ⁺	12	V
Power Dissipation	P _D	1500 (*JEDEC2 layers PCB mount)	mW
Operating Temperature Range	Topr	-20 to +75	°C
Storage Temperature Range	Tstg	-40 to +125	°C

**■ ELECTRICAL CHARACTERISTICS (Ta=25°C, V⁺=9V, R_L=47kΩ, Vin=100mVrms/1kHz
MODE ; VOL=0dB, BAL=0dB, SUR=OFF, AGC=OFF, BBE=OFF, Tone=0dB)**

PARAMETER	SYMBOL	TEST CONDITION	MIN.	TYP.	MAX.	UNIT
Operating Voltage	V ⁺		8.0	9.0	10.0	V
Supply Current	I _{CC}	No Signal	-	30	45	mA
Reference Voltage	V _{REF}	No Signal	4.0	4.5	5.0	V
Maximum Input Voltage	V _{IM}	VOL=-20dB, THD=10%	2.8	3.0	-	Vrms
Maximum Output Voltage	V _{OM}	OUTPUT VOL=0dB, THD=1%	-	2.5	-	Vrms
Channel Balance	G _{CB}	VOL=0dB	-1.5	0.0	1.5	dB
Balance Boost A	G _{BBA}	CHS="0", BAL=Mute Vin = 1Vrms	-2.0	0.0	2.0	dB
Balance Cut A	G _{BCA}	CHS="1", BAL=Mute Vin = 1Vrms	-	-	-70	dB
Balance Boost B	G _{BBB}	CHS="1", BAL=Mute Vin = 1Vrms	-2.0	0.0	2.0	dB
Balance Cut B	G _{BCB}	CHS="0", BAL=Mute Vin = 1Vrms	-	-	-70	dB
Total Harmonic Distortion	THD	Vo=0.5Vrms BW=400Hz to 30kHz	-	-	0.5	%
Maximum Voltage Gain	G _{VMAX}	VOL= 0dB	-2.0	0.0	2.0	dB
Minimum Voltage Gain	G _{VMIN}	VOL= Mute	-	-	-70	dB
MIX Output Voltage Gain	G _{VMIX}	MIXOUT, VOL=0dB	-2.0	0.0	2.0	dB
Line Output Voltage Gain	G _{VLINE}	LINEOUT, VOL=0dB	2.5	4.5	6.5	dB
Channel Separation	CS	Vin = 1Vrms	-	-	-70	dB
Output Noise 1	V _{NO1}	VOL = 0dB BW=400Hz to 30kHz	-	-90 (31.6)	-85 (56.2)	dBV (μVrms)
Output Noise 2	V _{NO2}	VOL = Mute BW = 400Hz to 30kHz	-	-106 (5.0)	-96 (15.8)	dBV (μVrms)
Output Noise 3	V _{NO3}	LINEOUT, VOL = 0dB BW=400Hz to 30kHz	-	-85 (56.2)	-80 (100)	dBV (μVrms)
Output Noise 4	V _{NO4}	LINEOUT, VOL = Mute BW = 400Hz to 30kHz	-	-101 (8.9)	-91 (28.2)	dBV (μVrms)

BW : Band Width

**◆ TONE CONTROL CHARACTERISTICS (Ta=25°C, V⁺=9V, R_L=47kΩ, Vin=100mVrms/1kHz
MODE ; VOL=0dB, BAL=0dB, SUR=OFF, AGC=OFF, BBE=OFF)**

PARAMETER	SYMBOL	TEST CONDITION	MIN.	TYP.	MAX.	UNIT
Treble Boost Gain	G _{HFBST}	TREB=+15dB, f=10kHz	12.5	15.0	17.5	dB
Treble Boost Flat	G _{HFFLT}	TREB=0dB, f=10kHz	-2.0	0.0	2.0	dB
Treble Boost Cut	G _{HFCUT}	TRBE=-15dB, f=10kHz	-17.5	-15.0	-12.5	dB
Bass Boost Gain	G _{LFBST}	BASS=+15dB, f=100Hz	12.5	15.0	17.5	dB
Bass Boost Flat	G _{LFFLT}	BASS=0dB, f=100Hz	-2.0	0.0	2.0	dB
Bass Boost Cut	G _{LF CUT}	BASS=-15dB, f=100Hz	-17.5	-15.0	-12.5	dB

◆AGC CHARACTERISTICS (Ta=25°C, V⁺=9V, R_L=47kΩ
MODE ; VOL=0dB, BAL=0dB, SUR=OFF, AGC=ON, BBE=OFF, Tone=0dB)

PARAMETER	SYMBOL	TEST CONDITION	MIN.	TYP.	MAX.	UNIT
AGC Boost	G _{AGCBST}	Vin=50mVrms, f=1kHz	1.5	3.5	5.5	dB
AGC Flat 1	G _{AGCFLT1}	Vin=300mVrms, f=1kHz	-2.5	0.0	2.5	dB
AGC Flat 2	G _{AGCFLT2}	Vin=400mVrms, f=1kHz	-2.5	0.0	2.5	dB
AGC Flat 3	G _{AGCFLT3}	Vin=500mVrms, f=1kHz	-2.5	0.0	2.5	dB
AGC Flat 4	G _{AGCFLT4}	Vin=600mVrms, f=1kHz	-2.5	0.0	2.5	dB
AGC Cut	G _{AGCCUT}	Vin=2Vrms, f=1kHz	-14	-10	-6.0	dB

◆BBE CHARACTERISTICS (Ta=25°C, V⁺=9V, R_L=47kΩ, Vin=100mVrms/1kHz
MODE ; VOL=0dB, BAL=0dB, SUR=OFF, AGC=OFF, Tone=0dB)

PARAMETER	SYMBOL	TEST CONDITION	MIN.	TYP.	MAX.	UNIT
Low Boost Gain	G _{BBELOW}	BBE-LOW =+15dB, f=50Hz	12.5	15	17.5	dB
High Boost Gain	G _{BBEHIGH}	BBE-HIGH=+15dB,f=10kHz	12.5	15	17.5	dB

◆eala CHARACTERISTICS (Ta=25°C, V⁺=9V, R_L=47kΩ, Vin=100mVrms/1kHz
MODE ; VOL=0dB, BAL=0dB, AGC=OFF, BBE=0dB, Tone=0dB)

PARAMETER	SYMBOL	TEST CONDITION	MIN.	TYP.	MAX.	UNIT
Simulated Stereo A	G _{SIMA}	LIN+RIN→OUTa, f=1KHz SUR=MONO	1.0	3.0	5.0	dB
Simulated Stereo B	G _{SIMB}	LIN+RIN→OUTb, f=1KHz SUR=MONO	1.0	3.0	5.0	dB
Surround 3D1	G _{3D1}	LIN→OUTa, f=100Hz SUR=eala6	10	12	14	dB
Surround 3D2	G _{3D2}	LIN→OUTa, f=10KHz SUR=eala6	-2.0	0.0	2.0	dB
Surround 3D3	G _{3D3}	LIN→OUTb, f=100Hz SUR=eala6	8	10	12	dB
Surround 3D4	G _{3D4}	LIN→OUTa, f=100Hz SUR=eala1	0	2	4	dB

◆TruSurround CHARACTERISTICS (Ta=25°C, V⁺=9V, R_L=47kΩ, Vin=100mVrms/1kHz
MODE; VOL=0dB, BAL=0dB, AGC=OFF, BBE=OFF, Tone=0dB)

PARAMETER	SYMBOL	TEST CONDITION	MIN.	TYP.	MAX.	UNIT
TruSurround Gain1	G _{TS1}	AIN→AOUT, f=1KHz SUR=TS	0.3	2.3	4.3	dB
TruSurround Gain2	G _{TS2}	AIN→BOUT, f=1KHz SUR=TS	-13.4	-11.4	-9.4	dB
TruSurround Gain3	G _{TS3}	A+BIN→COUT, f=1KHz SUR=TS2.1	-1.1	0.9	2.9	dB

◆SRS 3D CHARACTERISTICS (Ta=25°C, V⁺=9V, R_L=47kΩ, Vin=100mVrms/1kHz
MODE; VOL=0dB, BAL=0dB, AGC=OFF, BBE=OFF, Tone=0dB)

PARAMETER	SYMBOL	TEST CONDITION	MIN.	TYP.	MAX.	UNIT
Feed Through Gain	G _{THROUGH}	AIN→AOUT, f=1KHz SUR=SRS 3D	-20.2	-18.2	-16.2	dB
L+R Gain	G _{L+R}	AIN→AOUT, f=1KHz SUR=SRS 3D	-15.0	-13.0	-11.0	dB
L-R Gain	G _{L-R}	AIN→AOUT, f=125Hz SUR=SRS 3D	-2.0	0.0	2.0	dB

■ I²C BUS CHARACTERISTICS (SDA, SCL)

I²C BUS Load Conditions: Pull up resistance 4kΩ (Connected to +5V), Load capacitance 200pF (Connected to GND)

PARAMETER	SYMBOL	MIN.	TYP.	MAX.	UNIT
Low Level Input Voltage	V _{IL}	0.0	-	1.5	V
High Level Input Voltage	V _{IH}	3.0	-	5.0	V
Hysteresis of Schmitt trigger inputs	V _{hys}	0.25	-	-	V
LOW level output voltage (3mA at SDA pin)	V _{OL}	0	-	0.4	V
Output fall time from V _{IHmin} to V _{ILmax} with a bus capacitance from 10pF to 400pF	t _{of}	20+0.1C _b	-	250	ns
Pulse width of spikes which must be suppressed by the input filter	t _{SP}	0	-	50	ns
Input current each I/O pin with an input voltage between 0.1V _{DD} and 0.9V _{DDmax}	I _i	-10	-	10	μA
Capacitance for each I/O pin	C _i	-	-	10	pF
SCL clock frequency	f _{SCL}	-	-	400	kHz
Hold time (repeated) START condition.	t _{HD:STA}	0.6	-	-	μs
LOW period of the SCL clock	t _{LOW}	1.3	-	-	μs
HIGH period of the SCL clock	t _{HIGH}	0.6	-	-	μs
Set-up time for a repeated START condition	t _{SU:STA}	0.6	-	-	μs
Data hold time	t _{HD:DAT}	-	-	0.9	μs
Data set-up time	t _{SU:DAT}	100	-	-	ns
Rise time of both SDA and SCL signals	t _r	-	-	300	ns
Fall time of both SDA and SCL signals	t _f	-	-	300	ns
Set-up time for STOP condition	t _{SU:STO}	0.6	-	-	μs
Bus free time between a STOP and START condition	t _{BUF}	1.3	-	-	μs
Capacitive load for each bus line	C _b	-	-	400	pF
Noise margin at the LOW level	V _{nL}	0.5	-	-	V
Noise margin at the HIGH level	V _{nH}	1	-	-	V

C_b ; total capacitance of one bus line in pF.

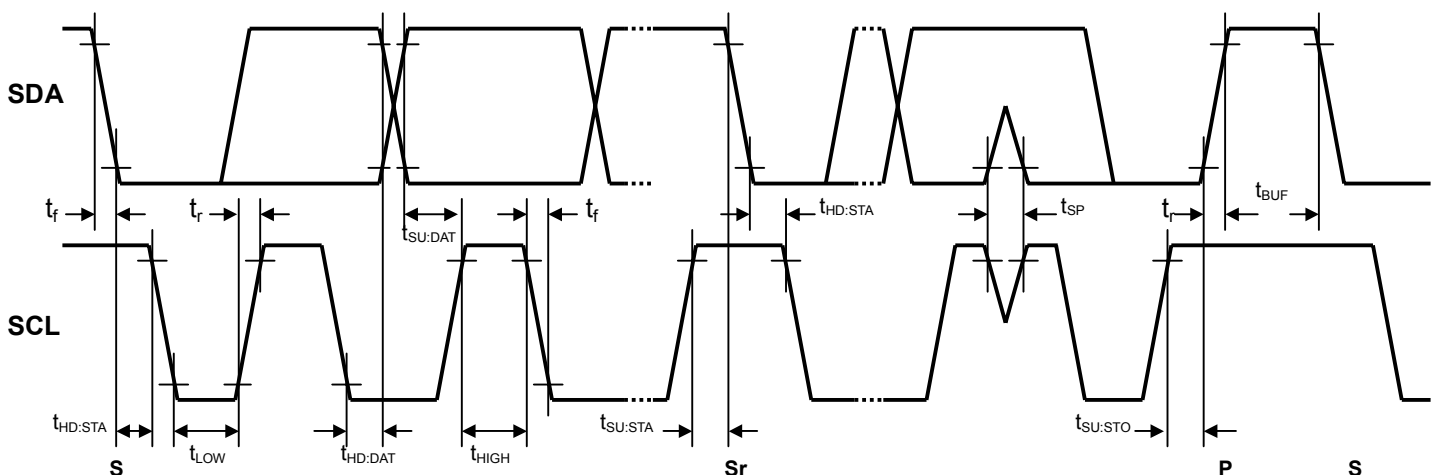

< MIXOUT, LFIN, LFOUT Low Pass Filter Setting >

LPF cut off frequency and quality factor are adjusted by the external parts and given by the following functions.

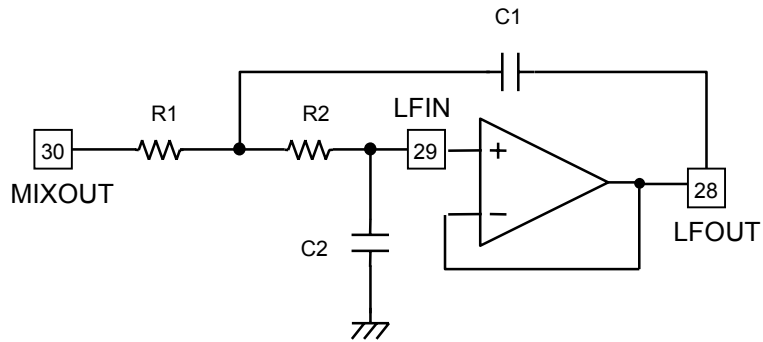

$$f_c = \frac{1}{2\pi\sqrt{R1 \cdot R2 \cdot C1 \cdot C2}} \text{ (Hz)}$$

$$Q = \frac{1}{\sqrt{\frac{C2 \cdot R1}{C1 \cdot R2}} + \sqrt{\frac{C1 \cdot R2}{C2 \cdot R1}}}$$

■ TERMINAL DESCRIPTION

PIN NO.	SYMBOL	FUNCTION	EQUIVALENT CIRCUIT	TERMINAL VOLTAGE
1 47 48	TS3 TS1 TS2	TruSurround Filter Capacitor 3 TruSurround Filter Capacitor 1 TruSurround Filter Capacitor 2		V+/2
2 37	INA INB	Ach Input Bch Input		V+/2
3 36 4 35	BBECHA BBECHB BBECLA BBECLB	Ach BBE High-Pass Filter Capacitor Bch BBE High-Pass Filter Capacitor Ach BBE Low-Pass Filter Capacitor Bch BBE Low-Pass Filter Capacitor		V+/2
5 34	TONECHA TONECHB	Ach TONE Treble Filter Capacitor Bch TONE Treble Filter Capacitor		V+/2

PIN NO.	SYMBOL	FUNCTION	EQUIVALENT CIRCUIT	TERMINAL VOLTAGE
6 33	TONECLA TONECLB	Ach TONE Bass Filter Capacitor Bch TONE Bass Filter Capacitor		V+/2
7 8 9 28 30 31 32	LINEOUTA OUTA OUTC LFOUT MIXOUT OUTB LINEOUTB	Ach Line Output Ach Output Center Output Buffer Output for LPF Ach Bch Mixed Output Bch Output Bch Line Output		V+/2
11	AGCTC	AGC Smoothing Filter Capacitor		1.4V
12	SURTC	Surround Switching Noise Rejection Capacitor		-

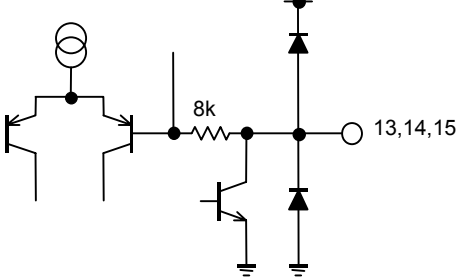
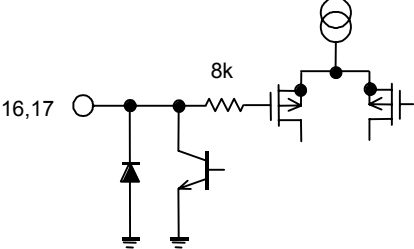
PIN NO.	SYMBOL	FUNCTION	EQUIVALENT CIRCUIT	TERMINAL VOLTAGE
13 14 15	VOLATC VOLBTC VOLCTC	A ch Volume Switching Noise Rejection Capacitor B ch Volume Switching Noise Rejection Capacitor Center ch Volume Switching Noise Rejection Capacitor		Vref-0.7V (Volume Max) (0dB)
16 17	SDA SCL	I ² C Data Input I ² C Clock Input		-
18	GND	Ground	-	-
20	V+	Power Supply	-	-

PIN NO.	SYMBOL	FUNCTION	EQUIVALENT CIRCUIT	TERMINAL VOLTAGE
21	VREF	Reference Voltage Stabilizing Capacitor		V+/2
22 23	TONEHTC TONE LTC	Tone Control Treble Switching Noise Rejection Capacitor Tone Control Bass Switching Noise Rejection Capacitor		Vref-0.7V (Tone=FLAT)
24	OUTTC	Line Output switching Noise Rejection Capacitor		5V (OUT-ON)
25	BBELTC	BBE Low Switching Noise Rejection Capacitor		Vref-0.7V (BBE=ON) (Low=0dB)

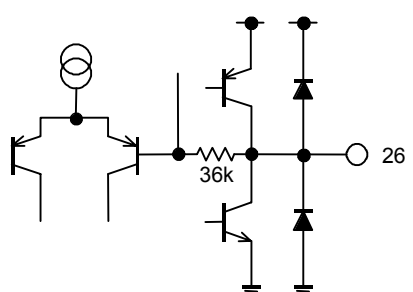
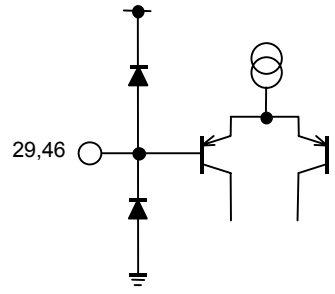
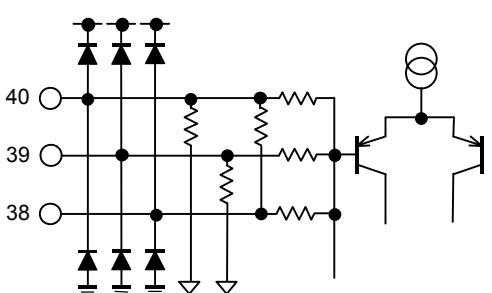
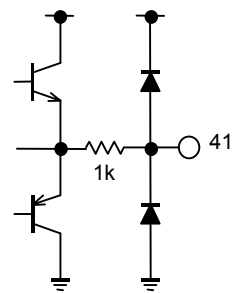
PIN NO.	SYMBOL	FUNCTION	EQUIVALENT CIRCUIT	TERMINAL VOLTAGE
26	BBEHTC	BBE High Switching Noise Rejection Capacitor		Vref-0.7V (High=0dB)
29 46	LFIN CEALA	Buffer Output for LPF eala Filter Capacitor		-
38 39 40	SRS4 SRS3 SRS2	SRS Filter Capacitor 4 SRS Filter Capacitor 3 SRS Filter Capacitor 2		V+/2
41	SRS1	SRS Filter Capacitor 1		V+/2

PIN NO.	SYMBOL	FUNCTION	EQUIVALENT CIRCUIT	TERMINAL VOLTAGE
42 43 45	SPACE1 CENTER SPACE2	SPACE Volume1 CENTER Volume SPACE Volume2		V+/2

● CONTROL COMMAND TABLE

a) Master Volume

Select Address	BIT							
	D7	D6	D5	D4	D3	D2	D1	D0
00H	VOL							

●VOL : Master Volume

Attenuation level : 0 to -80dB(0.33dB/step), MUTE

The volume is consisted of VOL1 and VOL2 and the level is divided into half to each VOL1 and VOL2.

ex) Volume setting is -2dB ; VOL1 and VOL2 is set -1dB each.

b) Balance

Select Address	BIT							
	D7	D6	D5	D4	D3	D2	D1	D0
01H	CHS	BAL					Don't Care	

●CHS : Balance channel select

“0” : Ach “Bch is attenuated”

“1” : Bch “Ach is attenuated”

●BAL : Ach and Bch Balance

Balance Level : 0 to -30dB (1dB/Step) , MUTE

c) Tone Control BASS

Select Address	BIT							
	D7	D6	D5	D4	D3	D2	D1	D0
02H	BCB	BASS					Don't Care	

●BCB : Bass Boost or Cut

“0” : Cut

“1” : Boost

●BASS : BASS Level

Cut Level : -15 to 0dB(0.5dB/Step)

Boost Level : 0 to +15dB(0.5dB/Step)

e) Tone Control TREBLE

Select Address	BIT							
	D7	D6	D5	D4	D3	D2	D1	D0
03H	BCT	TREB					Don't Care	

●BCT : Treble Boost or Cut

“0” : Cut

“1” : Boost

●TREB : Treble Level

Cut Level : -15 to 0dB(0.5dB/Step)

Boost Level : 0 to +15dB(0.5dB/Step)

f) BBE-Low

Select Address	BIT							
	D7	D6	D5	D4	D3	D2	D1	D0
04H	BBEL					BBE	Don't Care	

●BBEL:BBE-LOW Level

0dB to 15dB (0.5dB/step)

●BBE : BBE ON or OFF

g) BBE-High

Select Address	BIT							
	D7	D6	D5	D4	D3	D2	D1	D0
05H	BBEH					AGC	AGC LVL	

- BBEH: BBE-HIGH Level**
0dB to 15dB (0.5dB/step)

- AGC : AGC ON or OFF**
- AGC LVL : AGC Level**
300mVrms, 400mVrms, 500mVrms, 600mVrms

h) Surround (eala, TruSurround)

Select Address	BIT								
	D7	D6	D5	D4	D3	D2	D1	D0	
06H	2 / 2.1ch	SUR					OUT	Don't care	

- 2 / 2.1ch : Surround Output Mode**
2ch (TruSurround), 2.1ch (Center out)
- SUR : Surround Mode**
OFF, MONO, SRS 3D, TS, eala1, 2,3,4,5,6
- OUT : Output Switch**
Output ON / OFF

■ Master Volume (Select Address: 00H)

Gain(dB)	HEX	VOL							
		D7	D6	D5	D4	D3	D2	D1	D0
0	FF	1	1	1	1	1	1	1	1
-1	FC	1	1	1	1	1	1	0	0
-2	F9	1	1	1	1	1	0	0	1
-3	F6	1	1	1	1	0	1	1	0
-4	F3	1	1	1	1	0	0	1	1
-5	F0	1	1	1	1	0	0	0	0
-6	ED	1	1	1	0	1	1	0	1
-7	EA	1	1	1	0	1	0	1	0
-8	E7	1	1	1	0	0	1	1	1
-9	E4	1	1	1	0	0	1	0	0
-10	E1	1	1	1	0	0	0	0	1
-11	DE	1	1	0	1	1	1	1	0
-12	DB	1	1	0	1	1	0	1	1
-13	D8	1	1	0	1	1	0	0	0
-14	D5	1	1	0	1	0	1	0	1
-15	D2	1	1	0	1	0	0	1	0
-16	CF	1	1	0	0	1	1	1	1
-17	CC	1	1	0	0	1	1	0	0
-18	C9	1	1	0	0	1	0	0	1
-19	C6	1	1	0	0	0	1	1	0
-20	C3	1	1	0	0	0	0	1	1
-21	C0	1	1	0	0	0	0	0	0
-22	BD	1	0	1	1	1	1	0	1
-23	BA	1	0	1	1	1	0	1	0
-24	B7	1	0	1	1	0	1	1	1
-25	B4	1	0	1	1	0	1	0	0
-26	B1	1	0	1	1	0	0	0	1
-27	AE	1	0	1	0	1	1	1	0
-28	AB	1	0	1	0	1	0	1	1
-29	A8	1	0	1	0	1	0	0	0
-30	A5	1	0	1	0	0	1	0	1
-31	A2	1	0	1	0	0	0	1	0
-32	9F	1	0	0	1	1	1	1	1
-33	9C	1	0	0	1	1	1	0	0
-34	99	1	0	0	1	1	0	0	1
-35	96	1	0	0	1	0	1	1	0
-36	93	1	0	0	1	0	0	1	1
-37	90	1	0	0	1	0	0	0	0
-38	8D	1	0	0	0	1	1	0	1
-39	8A	1	0	0	0	1	0	1	0
-40	87	1	0	0	0	0	1	1	1
-41	84	1	0	0	0	0	1	0	0
-42	81	1	0	0	0	0	0	0	1

		VOL							
Gain(dB)	HEX	D7	D6	D5	D4	D3	D2	D1	D0
-43	7E	0	1	1	1	1	1	1	0
-44	7B	0	1	1	1	1	0	1	1
-45	78	0	1	1	1	1	0	0	0
-46	75	0	1	1	1	0	1	0	1
-47	72	0	1	1	1	0	0	1	0
-48	6F	0	1	1	0	1	1	1	1
-49	6C	0	1	1	0	1	1	0	0
-50	69	0	1	1	0	1	0	0	1
-51	66	0	1	1	0	0	1	1	0
-52	63	0	1	1	0	0	0	1	1
-53	60	0	1	1	0	0	0	0	0
-54	5D	0	1	0	1	1	1	0	1
-55	5A	0	1	0	1	1	0	1	0
-56	57	0	1	0	1	0	1	1	1
-57	54	0	1	0	1	0	1	0	0
-58	51	0	1	0	1	0	0	0	1
-59	4E	0	1	0	0	1	1	1	0
-60	4B	0	1	0	0	1	0	1	1
-61	48	0	1	0	0	1	0	0	0
-62	45	0	1	0	0	0	1	0	1
-63	42	0	1	0	0	0	0	1	0
-64	3F	0	0	1	1	1	1	1	1
-65	3C	0	0	1	1	1	1	0	0
-66	39	0	0	1	1	1	0	0	1
-67	36	0	0	1	1	0	1	1	0
-68	33	0	0	1	1	0	0	1	1
-69	30	0	0	1	1	0	0	0	0
-70	2D	0	0	1	0	1	1	0	1
-71	2A	0	0	1	0	1	0	1	0
-72	27	0	0	1	0	0	1	1	1
-73	24	0	0	1	0	0	1	0	0
-74	21	0	0	1	0	0	0	0	1
-75	1E	0	0	0	1	1	1	1	0
-76	1B	0	0	0	1	1	0	1	1
-77	18	0	0	0	1	1	0	0	0
-78	15	0	0	0	1	0	1	0	1
-79	12	0	0	0	1	0	0	1	0
-80	0F	0	0	0	0	1	1	1	1
Mute	00	0	0	0	0	0	0	0	0

■ **Balance (Select Address: 01H)**

Channel Setting (CHS)	D7
Attenuated Bch Gain	0
Attenuated Ach Gain	1

Gain(dB)	BAL				
	D6	D5	D4	D3	D2
0	0	0	0	0	0
-1	0	0	0	0	1
-2	0	0	0	1	0
-3	0	0	0	1	1
-4	0	0	1	0	0
-5	0	0	1	0	1
-6	0	0	1	1	0
-7	0	0	1	1	1
-8	0	1	0	0	0
-9	0	1	0	0	1
-10	0	1	0	1	0
-11	0	1	0	1	1
-12	0	1	1	0	0
-13	0	1	1	0	1
-14	0	1	1	1	0
-15	0	1	1	1	1
-16	1	0	0	0	0
-17	1	0	0	0	1
-18	1	0	0	1	0
-19	1	0	0	1	1
-20	1	0	1	0	0
-21	1	0	1	0	1
-22	1	0	1	1	0
-23	1	0	1	1	1
-24	1	1	0	0	0
-25	1	1	0	0	1
-26	1	1	0	1	0
-27	1	1	0	1	1
-28	1	1	1	0	0
-29	1	1	1	0	1
-30	1	1	1	1	0
MUTE	1	1	1	1	1

■ Tone Control Bass (Select Address: 02H)

Bass Cut or Boost	BCB D7
Cut	0
Boost	1

		BASS				
Cut Gain(dB)	Boost Gain(dB)	D6	D5	D4	D3	D2
-15	15	1	1	1	1	0
-14	14	1	1	1	0	0
-13	13	1	1	0	1	0
-12	12	1	1	0	0	0
-11	11	1	0	1	1	0
-10	10	1	0	1	0	0
-9	9	1	0	0	1	0
-8	8	1	0	0	0	0
-7	7	0	1	1	1	0
-6	6	0	1	1	0	0
-5	5	0	1	0	1	0
-4	4	0	1	0	0	0
-3	3	0	0	1	1	0
-2	2	0	0	1	0	0
-1	1	0	0	0	1	0
0	0	0	0	0	0	0

■ Tone Control Treble (Select Address: 03H)

Treble Cut or Boost	BCT D7
Cut	0
Boost	1

		TREB				
Cut Gain(dB)	Boost Gain(dB)	D6	D5	D4	D3	D2
-15	15	1	1	1	1	0
-14	14	1	1	1	0	0
-13	13	1	1	0	1	0
-12	12	1	1	0	0	0
-11	11	1	0	1	1	0
-10	10	1	0	1	0	0
-9	9	1	0	0	1	0
-8	8	1	0	0	0	0
-7	7	0	1	1	1	0
-6	6	0	1	1	0	0
-5	5	0	1	0	1	0
-4	4	0	1	0	0	0
-3	3	0	0	1	1	0
-2	2	0	0	1	0	0
-1	1	0	0	0	1	0
0	0	0	0	0	0	0

■ BBE-LOW Gain Code (Select Address: 04H)

Gain(dB)	BBEL				
	D7	D6	D5	D4	D3
15	1	1	1	1	0
14	1	1	1	0	0
13	1	1	0	1	0
12	1	1	0	0	0
11	1	0	1	1	0
10	1	0	1	0	0
9	1	0	0	1	0
8	1	0	0	0	0
7	0	1	1	1	0
6	0	1	1	0	0
5	0	1	0	1	0
4	0	1	0	0	0
3	0	0	1	1	0
2	0	0	1	0	0
1	0	0	0	1	0
0	0	0	0	0	0

■ BBE (Select Address: 04H)

BBE ON/OFF	BBE
	D2
OFF	0
ON	1

■ BBE-HIGH Gain Code (Select Address: 05H)

Gain(dB)	BBEH				
	D7	D6	D5	D4	D3
15	1	1	1	1	0
14	1	1	1	0	0
13	1	1	0	1	0
12	1	1	0	0	0
11	1	0	1	1	0
10	1	0	1	0	0
9	1	0	0	1	0
8	1	0	0	0	0
7	0	1	1	1	0
6	0	1	1	0	0
5	0	1	0	1	0
4	0	1	0	0	0
3	0	0	1	1	0
2	0	0	1	0	0
1	0	0	0	1	0
0	0	0	0	0	0

■ AGC (Select Address: 05H)

AGC ON/OFF	AGC
	D2
OFF	0
ON	1

■ AGC Level (Select Address: 05H)

AGC Level	AGC LVL	
	D1	D0
300mVrms	0	0
400mVrms	0	1
500mVrms	1	0
600mVrms	1	1

■ 2 / 2.1ch (Select Address: 06H)

2 / 2.1ch	2 / 2.1ch
	D7
2ch	0
2.1ch	1

■ Surround Mode (Select Address: 06H)

SUR	SUR			
	D6	D5	D4	D3
OFF	0	0	0	0
MONO	1	1	1	1
SRS 3D	1	1	1	0
TS	1	1	0	1
eala 1	0	0	0	1
eala 2	0	0	1	0
eala 3	0	0	1	1
eala 4	0	1	0	0
eala 5	0	1	0	1
eala 6	0	1	1	0

■ Output Switch (Select Address: 06H)

Output Switch	OUT
	D2
OFF	0
ON	1

■ TYPICAL CHARACTERISTICS

Operating Current vs. Power Supply Voltage

$R_L=47k\Omega$, VOL=0dB, BAL=0dB, AGC=OFF,
BASS=TREB=0dB, BBE=OFF, Surround=OFF

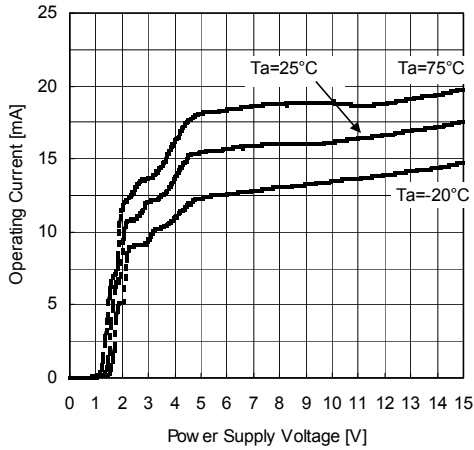

Operating Current vs. Ambient Temperature

$V+=9V$, $R_L=47k\Omega$, VOL=0dB, BAL=0dB, AGC=OFF,
BASS=TREB=0dB, BBE=OFF, Surround=OFF

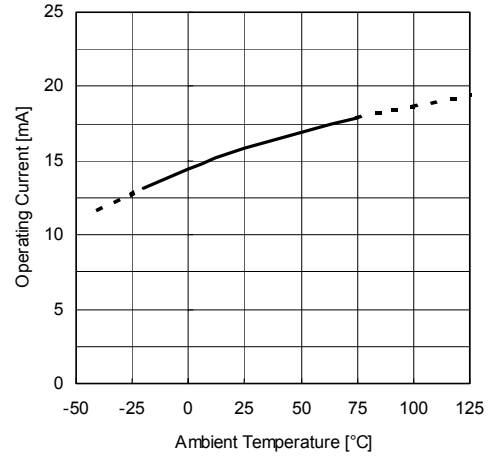

Reference Voltage vs. Power Supply Voltage

$R_L=47k\Omega$, VOL=0dB, BAL=0dB, AGC=OFF,
BASS=TREB=0dB, BBE=OFF, Surround=OFF

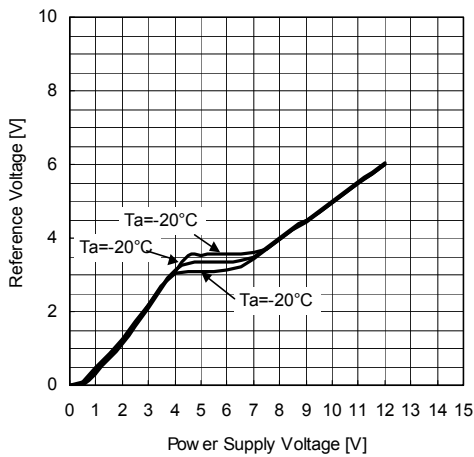

Reference Voltage vs. Ambient Temperature

$V+=9V$, $R_L=47k\Omega$, VOL=0dB, BAL=0dB, AGC=OFF,
BASS=TREB=0dB, BBE=OFF, Surround=OFF

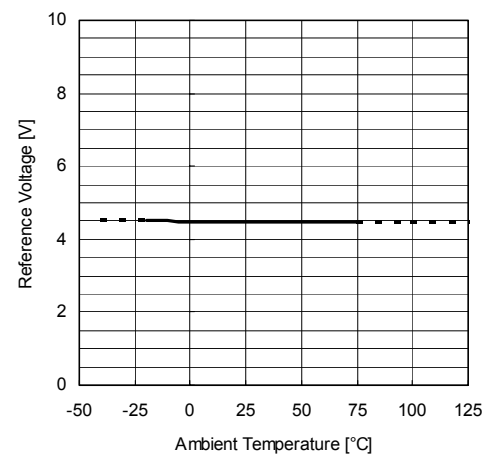

Voltage Gain vs. Volume Control

$V+=9V$, $R_L=47k\Omega$, $V_{in}(Ach)=1V_{rms}$, $f=1kHz$, BW=400Hz-30kHz,
BAL=0dB, AGC=OFF, BASS=TREB=0dB, BBE=OFF, Surround=OFF

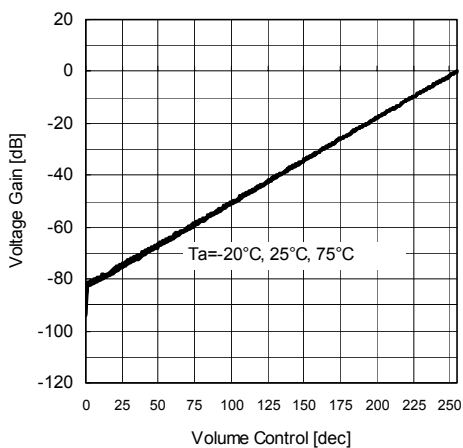

Voltage Gain vs. Balance Control

$V+=9V$, $R_L=47k\Omega$, $V_{in}(Ach)=1V_{rms}$, $f=1kHz$, BW=400Hz-30kHz,
VOL=0dB, AGC=OFF, BASS=TREB=0dB, BBE=OFF, Surround=OFF

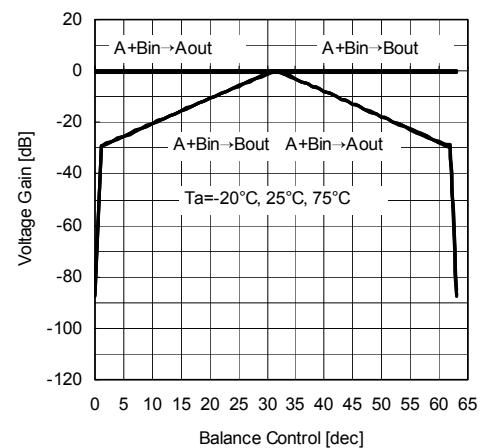

■ TYPICAL CHARACTERISTICS

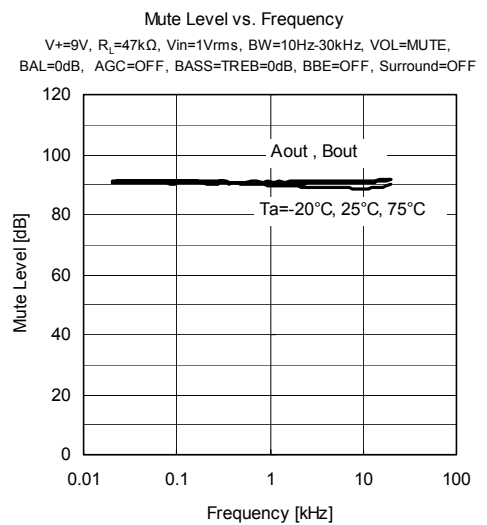
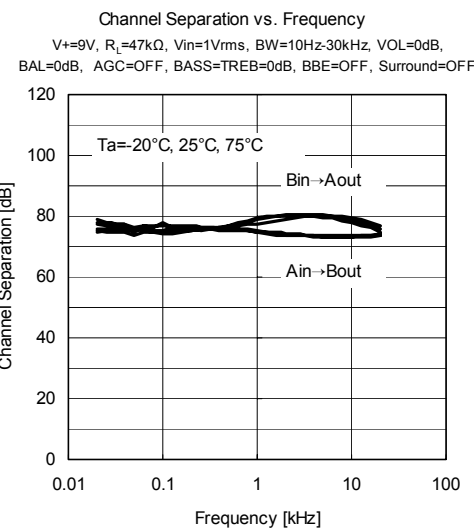
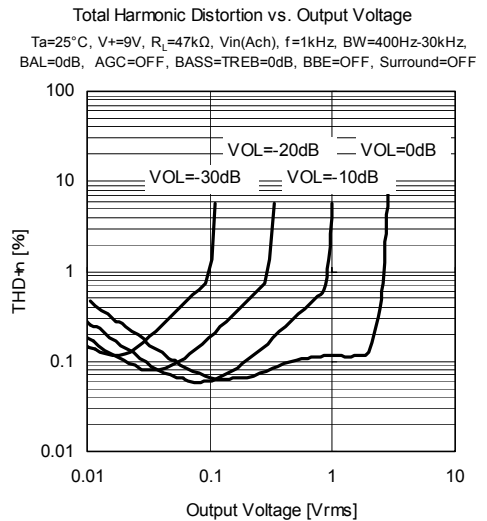
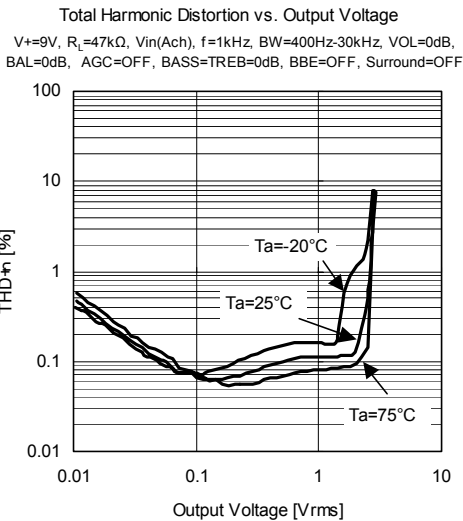
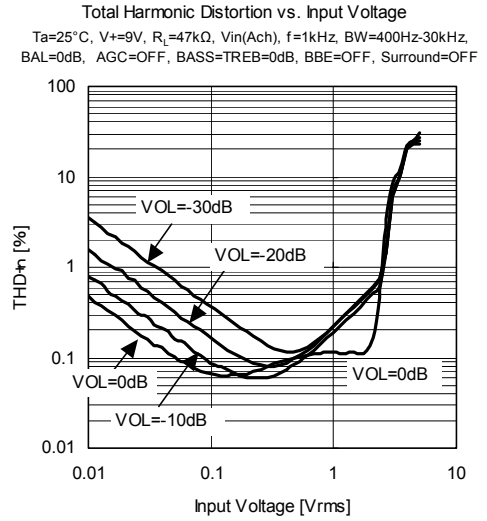
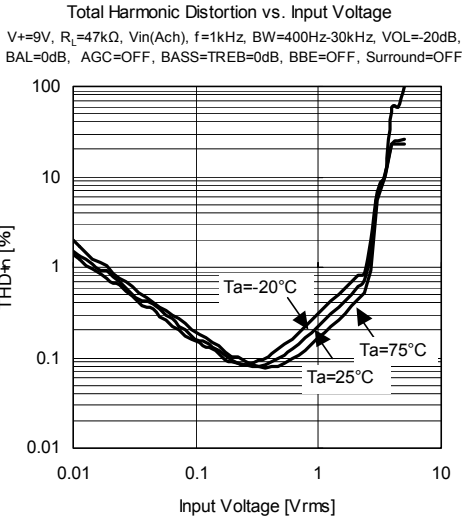

■ TYPICAL CHARACTERISTICS

Voltage Gain (LINE) vs. Frequency
 Ta=25°C, V+=9V, R_L=47kΩ, Vin(Ach)=0.1Vrms, Vout(LINEAch),
 VOL=0dB, BAL=0dB, AGC=OFF, BASS=TREB=0dB, BBE=OFF, Surround=OFF

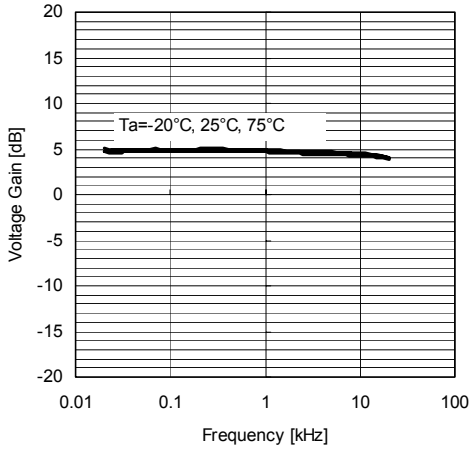

Output Noise Voltage (OUT) vs. Frequency
 V+=9V, R_L=47kΩ, BAL=0dB, AGC=OFF,
 BASS=TREB=0dB, BBE=OFF, Surround=OFF

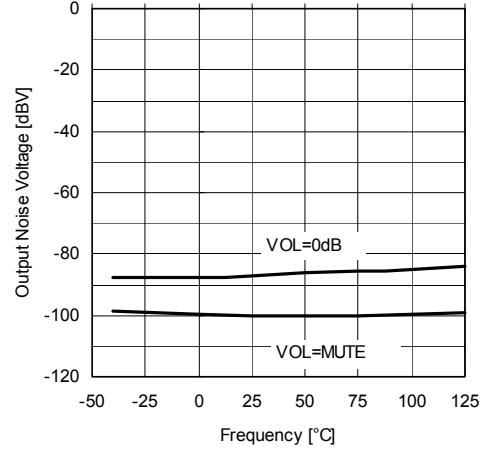

Output Noise Voltage (LINE) vs. Frequency
 V+=9V, R_L=47kΩ, BAL=0dB, AGC=OFF,
 BASS=TREB=0dB, BBE=OFF, Surround=OFF

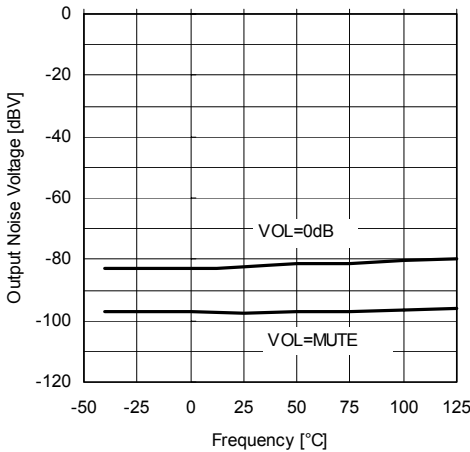

AGC Output Voltage vs. Input Voltage
 V+=9V, R_L=47kΩ, Vin(A+Bch), f=1kHz, Vout(Ach), BW=400Hz-30kHz,
 VOL=0dB, BAL=0dB, AGC=300mV, BASS=TREB=0dB, BBE=OFF, Surround=OFF

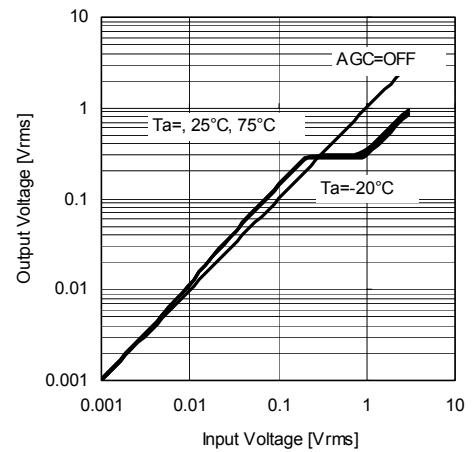

AGC Output Voltage vs. Input Voltage
 Ta=25°C, V+=9V, R_L=47kΩ, Vin(A+Bch), f=1kHz, Vout(Ach), BW=400Hz-30kHz,
 VOL=0dB, BAL=0dB, BASS=TREB=0dB, BBE=OFF, Surround=OFF

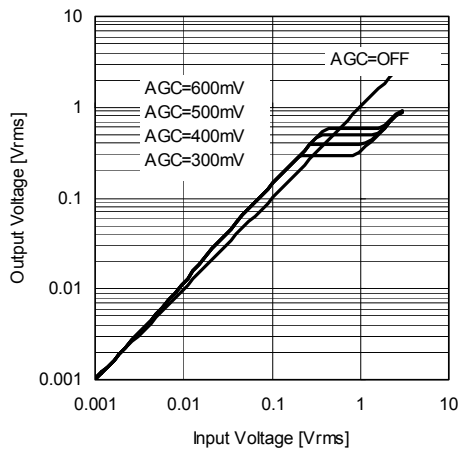

AGC Attack Time Response
 Ta=25°C, V+=9V, R_L=47kΩ, Vin(A+Bch), f=20kHz, Vout(Ach), BW=400Hz-30kHz,
 VOL=0dB, BAL=0dB, AGC=300mV, BASS=TREB=0dB, BBE=OFF, Surround=OFF

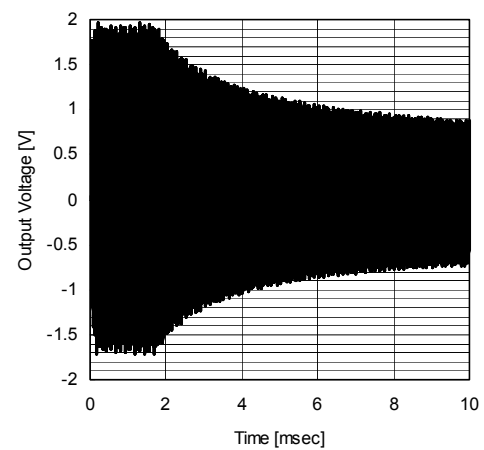

TYPICAL CHARACTERISTICS

AGC Recovery Time Response

Ta=25°C, V+=9V, R_L=47kΩ, Vin(A+Bch), f=10kHz, Vout(Ach), BW=400Hz-30kHz, VOL=0dB, BAL=0dB, AGC=300mV, BASS=TREB=0dB, BBE=OFF, Surround=OFF

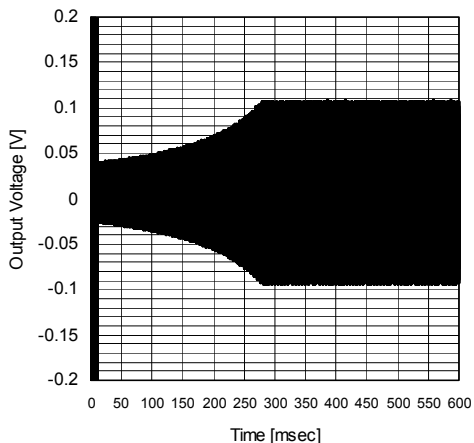

Voltage Gain vs. Frequency (TONE)

Ta=25°C, V+=9V, R_L=47kΩ, Vin(Ach)=0.1Vrms, Vout(Ach), VOL=0dB, BAL=0dB, AGC=OFF, BBE=OFF, eala=By pass, TS=By pass

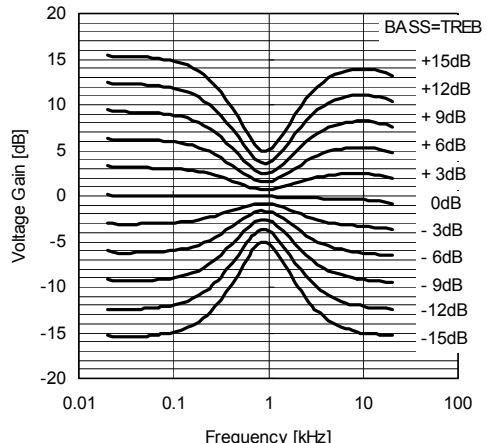

Voltage Gain vs. Frequency (TONE)

Ta=25°C, V+=9V, R_L=47kΩ, Vin(Ach)=0.1Vrms, Vout(Ach), VOL=0dB, BAL=0dB, AGC=OFF, BBE=OFF, eala=By pass, TS=By pass

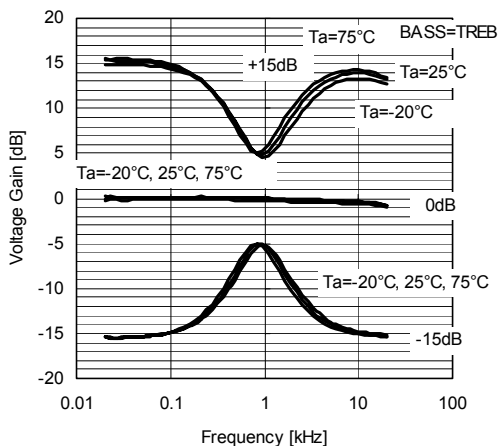

Voltage Gain vs. Frequency (BBE)

Ta=25°C, V+=9V, R_L=47kΩ, Vin(Lch)=0.1Vrms, Vout(Ach), VOL=0dB, BAL=0dB, BASS=TREB=0dB, AGC=OFF, Surround=OFF

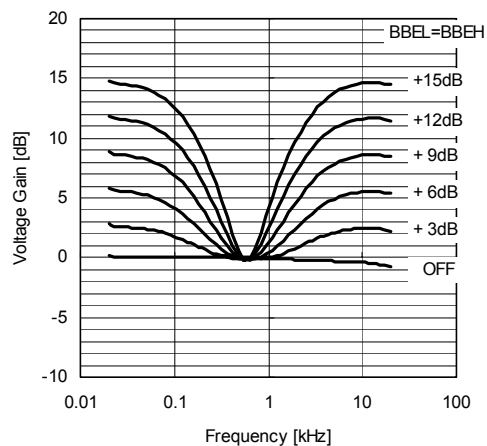

Voltage Gain vs. Frequency (BBE)

V+=9V, R_L=47kΩ, Vin(Lch)=0.1Vrms, Vout(Ach), VOL=0dB, BAL=0dB, BASS=TREB=0dB, AGC=OFF, Surround=OFF

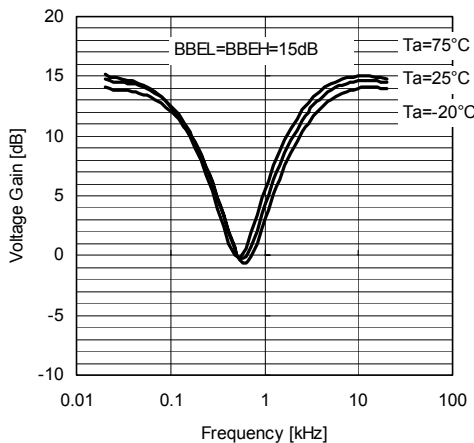

Phase vs. Frequency (BBE)

Ta=25°C, V+=9V, R_L=47kΩ, Vin(Lch)=0.1Vrms, Vout(Ach), VOL=0dB, BAL=0dB, BASS=TREB=0dB, AGC=OFF, Surround=OFF

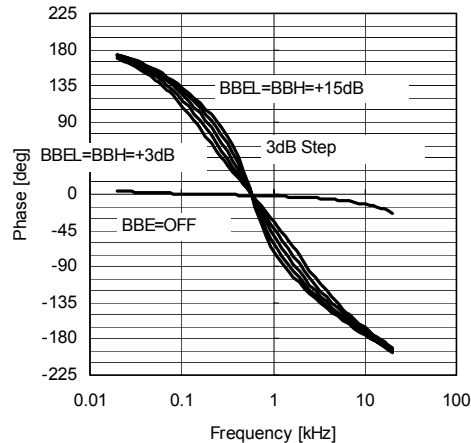

■ TYPICAL CHARACTERISTICS

Voltage Gain vs. Frequency (MONO)

V+=9V, R_L=47kΩ, Vin(A+Bch)=0.1Vrms, Vout(Ach), VOL=0dB, BAL=0dB, BASS=TREB=0dB, AGC=OFF, BBE=OFF, Surround=MONO

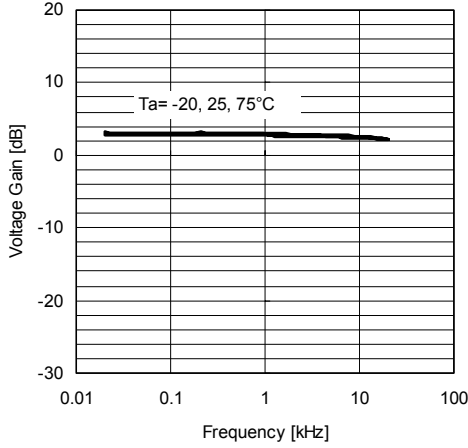

Phase vs. Frequency (MONO)

V+=9V, R_L=47kΩ, Vin(A+Bch)=0.1Vrms, VOL=0dB, BAL=0dB, BASS=TREB=0dB, AGC=OFF, BBE=OFF, Surround=MONO

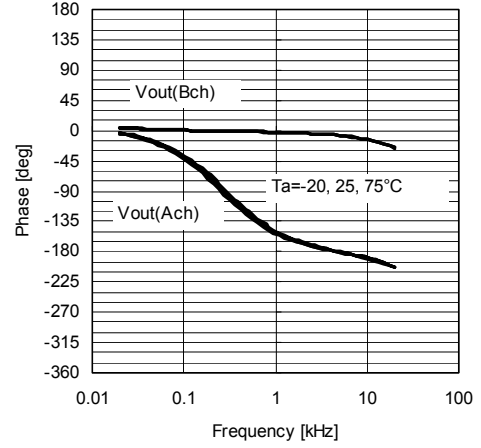

Voltage Gain vs. Frequency (eala Ach)

V+=9V, R_L=47kΩ, Vin=0.1Vrms, Vout(Ach), VOL=0dB, BAL=0dB, BASS=TREB=0dB, AGC=OFF, BBE=OFF, Surround=eala

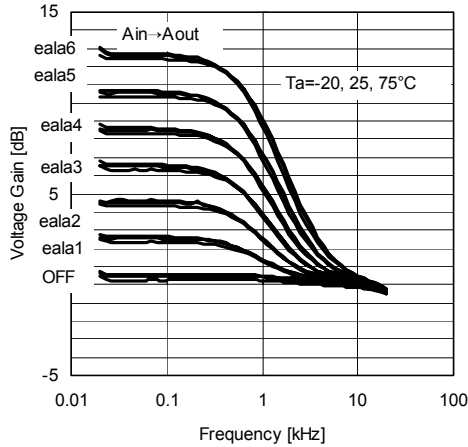

Voltage Gain vs. Frequency (eala Bch)

V+=9V, R_L=47kΩ, Vin=0.1Vrms, Vout(Ach), VOL=0dB, BAL=0dB, BASS=TREB=0dB, AGC=OFF, BBE=OFF, Surround=eala

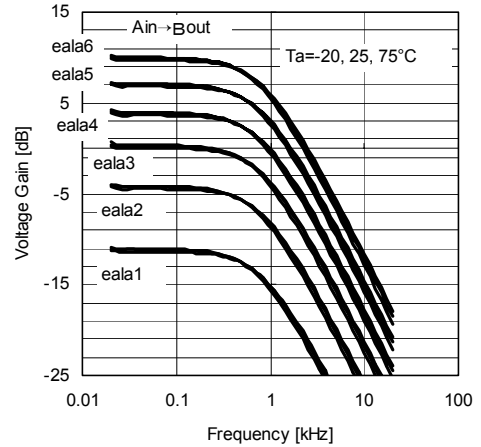

Voltage Gain vs. Frequency (TS2)

V+=9V, R_L=47kΩ, Vin=0.1Vrms, VOL=0dB, BAL=0dB, BASS=TREB=0dB, AGC=OFF, BBE=OFF, Surround=TS_2ch

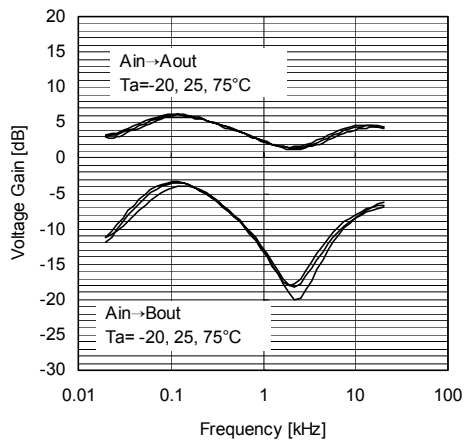

Voltage Gain vs. Frequency (TS2.1)

V+=9V, R_L=47kΩ, Vin=0.1Vrms, VOL=0dB, BAL=0dB, BASS=TREB=0dB, AGC=OFF, BBE=OFF, Surround=TS_2.1ch

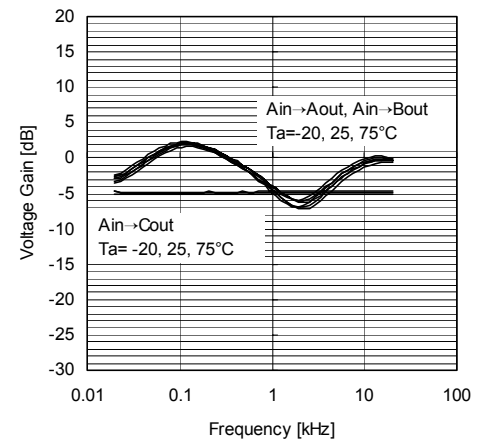

TYPICAL CHARACTERISTICS

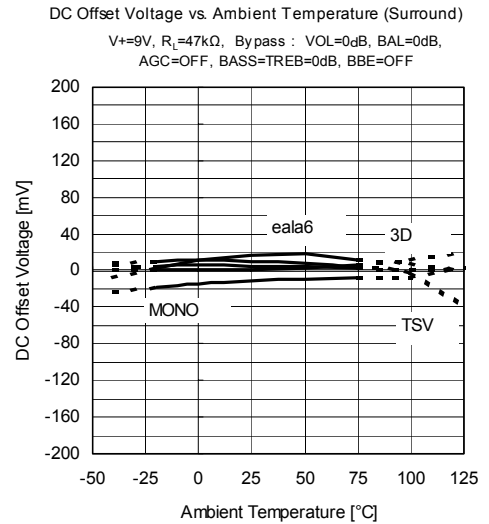
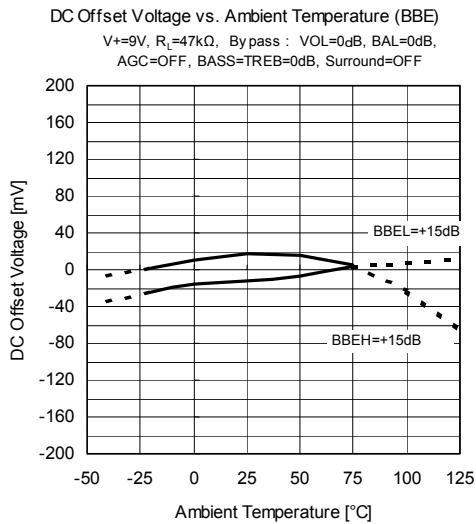
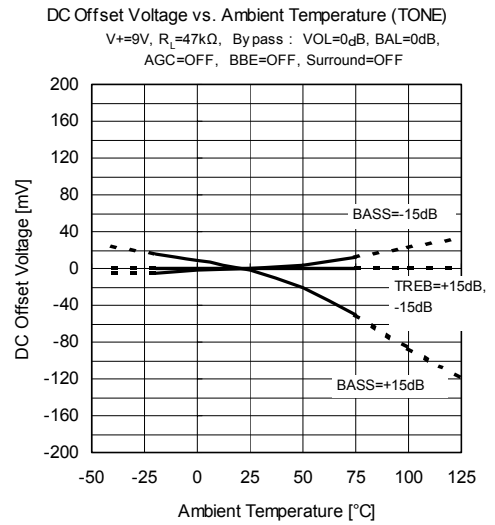
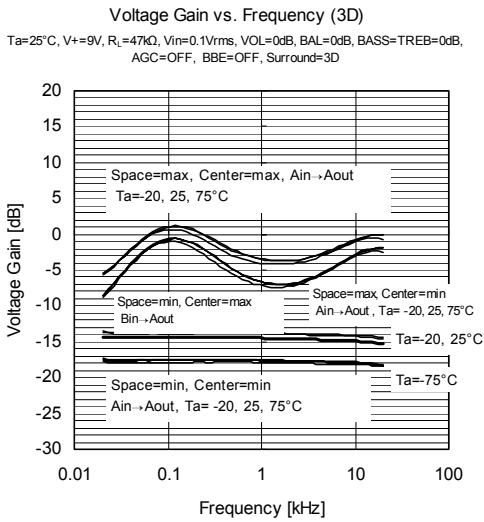

■NOTE

The **NJW1148** is manufactured by New Japan Radio Co., Ltd. under license from BBE Sound Inc. BBE is a registered trademark of BBE Sound Inc. A license from BBE Sound Inc. is required before the **NJW1148** can be purchased from New Japan Radio Co.,Ltd.

BBE Sound, Inc.
5381 Production Drive
Huntington Beach, CA 92649
Tel:(714)897-6766
Fax:(714)896-0736

The TruSurround technology right incorporated in the **NJW1148** are owned by SRS Labs, a U.S. Corporation and licensed to New Japan Radio Co., Ltd. Purchaser of **NJW1148** must sign a license for use of the chip and display of the SRS Labs trademarks. Any products incorporating the **NJW1148** must be sent to SRS Labs for review. TruSurround is protected under U.S. and foreign patents issued and/or pending. TruSurround, SRS and the  symbol are trademarks of SRS Labs, Inc. in the United States and selected foreign countries. Neither the purchase of the **NJW1148**, nor the corresponding sale of audio enhancement equipment conveys the right to sell commercialized recordings made with any SRS technology.

SRS Labs requires all set makers to comply with all rules and regulations as outlined in the SRS Trademark Usage Manual separately provided.

For further information, please contact:
SRS Labs, Inc.
2909 Daimler Street. Santa Ana, CA 92705 USA
Tel: 949-442-1070 Fax: 949-852-1099 <http://www.srslabs.com>

Purchase of I²C components of New Japan Radio Co., Ltd or one of its sublicensed Associated Companies conveys a license under the Philips I²C Patent Rights to use these components in an I²C system, provided that the system conforms to the I²C Standard Specification as defined by Philips.

[CAUTION]

The specifications on this databook are only given for information, without any guarantee as regards either mistakes or omissions. The application circuits in this databook are described only to show representative usages of the product and not intended for the guarantee or permission of any right including the industrial rights.