

LOW-POWER DUAL C-MOS OPERATIONAL AMPLIFIER

■ GENERAL DESCRIPTION

The NJU7014,15 and 16 are dual C-MOS operational amplifiers operated on a single-power-supply, low voltage and low operating current.

The input bias current is as low as than 1pA, consequently very small signal around the ground level can be amplified.

The minimum operating voltage is 1V and the output stage permits output signal to swing between both of the supply rails.

Furthermore, this series is packaged with a various small one therefore it can be especially applied to portable items.

■ PACKAGE OUTLINE

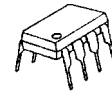

NJU701XD



NJU701XM



NJU701XV



NJU701XR



NJU701XRB1

■ FEATURES

- Single-Power-Supply
- Wide Operating Voltage ($V_{DD}=1\sim 5.5V$)
- Wide Output Swing Range ($V_{OM}=2.9V$ min. @ 3.0V)
- Low Operating Current
- Low Bias Current ($I_B=1pA$ typ.)
- Compensation Capacitor Incorporated
- Package Outline DIP8, DMP8, SSOP8, VSP8, TVSP8
- C-MOS Technology

■ PIN CONFIGURATION

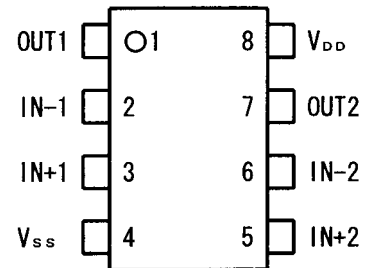

■ LINE-UP

($T_a=25^\circ C, V_{DD}=3.0V$, Per Circuit)

PARAMETER	NJU7014	NJU7015	NJU7016	UNIT
Operating Current	15	80	200	μA (typ)
Slew Rate	0.1	1.0	2.4	$V/\mu s$ (typ)
Unity Gain Bandwidth	0.2	1.0	1.0	MHz (typ)

■ EQUIVALENT CIRCUIT

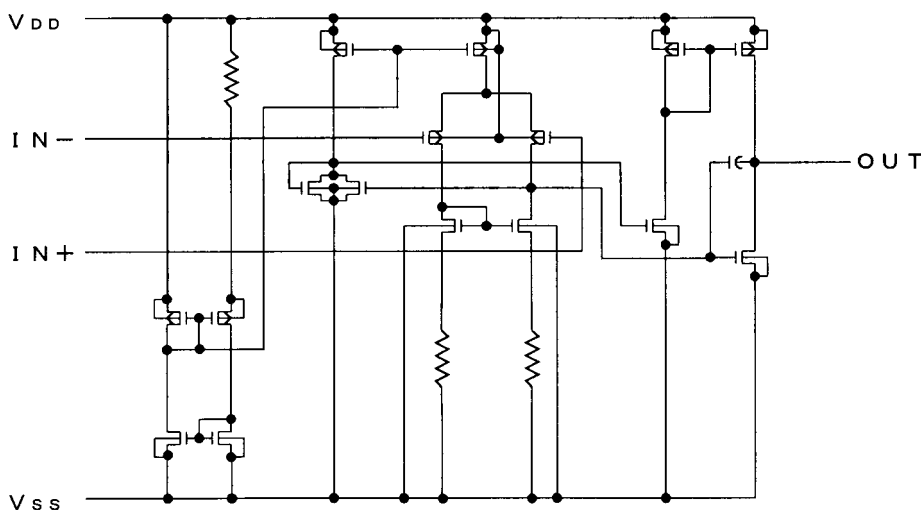

NJU7014/15/16

■ ABSOLUTE MAXIMUM RATINGS

(Ta=25°C)

PARAMETER	SYMBOL	RATINGS	UNIT
Supply Voltage	V _{DD}	7	V
Differential Input Voltage	V _{ID}	± 7 (note1)	V
Common Mode Input Voltage	V _{IC}	-0.3~7	V
Power Dissipation	P _D	(DIP8) 500 (DMP8) 300 (SSOP8) 250 (TVSP8) 320	mW
Operating Temperature Range	T _{opr}	-40~+85	°C
Storage Temperature Range	T _{stg}	-55~+125	°C

(note1) If the supply voltage (V_{DD}) is less than 7V, the input voltage must not over the V_{DD} level though 7V is limit specified.

(note2) Decoupling capacitor should be connected between V_{DD} and V_{SS} due to the stabilized operation for the circuit.

■ ELECTRICAL CHARACTERISTICS

NJU7014

(Ta=25°C, V_{DD}=3.0V, R_L=∞)

PARAMETER	SYMBOL	TEST CONDITION	MIN.	TYP.	MAX.	UNIT
Input Offset Voltage	V _{IO}	V _{IN} =1/2V _{DD}	-	-	10	mV
Input Offset Current	I _{IO}		-	1	-	pA
Input Bias Current	I _{IB}		-	1	-	pA
Input Impedance	R _{IN}		-	1	-	TΩ
Large Signal Voltage Gain	A _{VD}		60	70	-	dB
Input Common Mode Voltage Range	V _{ICM}		0~2.5	-	-	V
Maximum Output Swing Voltage	V _{OM1}	R _L =1MΩ	V _{DD} -0.1	-	-	V
	V _{OM2}	R _L =1MΩ	-	-	V _{SS} +0.1	V
Common Mode Rejection Ratio	CMR	V _{IN} =1/2V _{DD}	55	65	-	dB
Supply Voltage Rejection Ratio	SVR	V _{DD} =1.5~5.5V	60	70	-	dB
Operating Current	I _{DD}	Per Circuit	-	15	25	μA
Slew Rate	SR		-	0.1	-	V/μs
Unity Gain Bandwidth	F _t	A _v =40dB, C _L =10pF	-	0.2	-	MHz

(note3) The source current is less than 2.9μA (at V_{OM}/R_L=2.9V/1MΩ).

NJU7015

(Ta=25°C, V_{DD}=3.0V, R_L=∞)

PARAMETER	SYMBOL	TEST CONDITION	MIN.	TYP.	MAX.	UNIT
Input Offset Voltage	V _{IO}	V _{IN} =1/2V _{DD}	-	-	10	mV
Input Offset Current	I _{IO}		-	1	-	pA
Input Bias Current	I _{IB}		-	1	-	pA
Input Impedance	R _{IN}		-	1	-	TΩ
Large Signal Voltage Gain	A _{VD}		60	70	-	dB
Input Common Mode Voltage Range	V _{ICM}		0~2.5	-	-	V
Maximum Output Swing Voltage	V _{OM1}	R _L =100kΩ	V _{DD} -0.1	-	-	V
	V _{OM2}	R _L =100kΩ	-	-	V _{SS} +0.1	V
Common Mode Rejection Ratio	CMR	V _{IN} =1/2V _{DD}	55	65	-	dB
Supply Voltage Rejection Ratio	SVR	V _{DD} =1.5~5.5V	60	70	-	dB
Operating Current	I _{DD}	Per Circuit	-	80	160	μA
Slew Rate	SR		-	1.0	-	V/μs
Unity Gain Bandwidth	F _t	A _v =40dB, C _L =10pF	-	1.0	-	MHz

(note4) The source current is less than 29μA (at V_{OM}/R_L=2.9V/100kΩ).

NJU7016

(Ta=25°C, V_{DD}=3.0V, R_L=∞)

PARAMETER	SYMBOL	TEST CONDITION	MIN.	TYP.	MAX.	UNIT
Input Offset Voltage	V _{IO}	V _{IN} =1/2V _{DD}	-	-	10	mV
Input Offset Current	I _{IO}		-	1	-	pA
Input Bias Current	I _{IB}		-	1	-	pA
Input Impedance	R _{IN}		-	1	-	TΩ
Large Signal Voltage Gain	A _{VD}		60	70	-	dB
Input Common Mode Voltage Range	V _{ICM}		0~2.5	-	-	V
Maximum Output Swing Voltage	V _{OM1}	R _L =50kΩ	V _{DD} -0.1	-	-	V
	V _{OM2}	R _L =50kΩ	-	-	V _{SS} +0.1	V
Common Mode Rejection Ratio	CMR	V _{IN} =1/2V _{DD}	55	65	-	dB
Supply Voltage Rejection Ratio	SVR	V _{DD} =1.5~5.5V	60	70	-	dB
Operating Current	I _{DD}	Per Circuit	-	200	400	μA
Slew Rate	SR		-	1.0	-	V/μs
Unity Gain Bandwidth	F _t	A _v =40dB, C _L =10pF	-	1.0	-	MHz

(note5) The source current is less than 58μA (at V_{OM}/R_L=2.9V/50kΩ).

■ TYPICAL CHARACTERISTICS

(1) NJU7014

Output Voltage vs. Output Current (SOURCE)

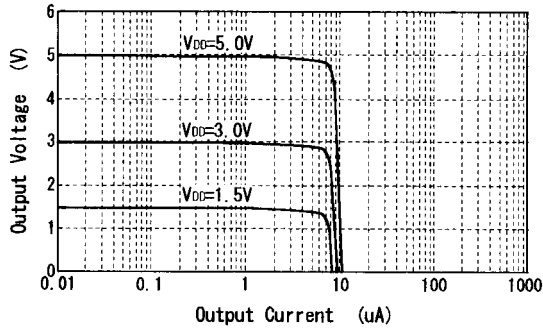

Output Voltage vs. Output Current (SINK)

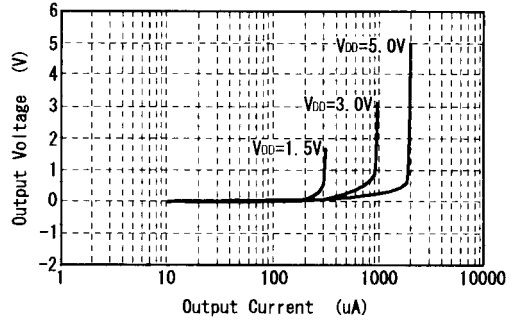

Operating Current vs. Operating Voltage

V_{IN}=0.1V

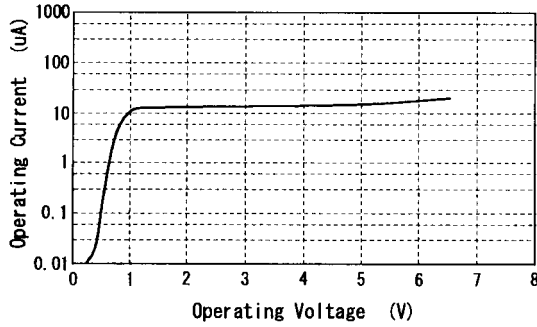

Output Current vs. Operating Voltage

V_{IN}=0.1V

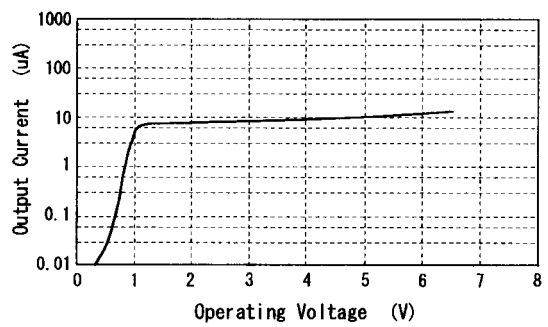

Maximum Output Swing Voltage vs. Load Resistance

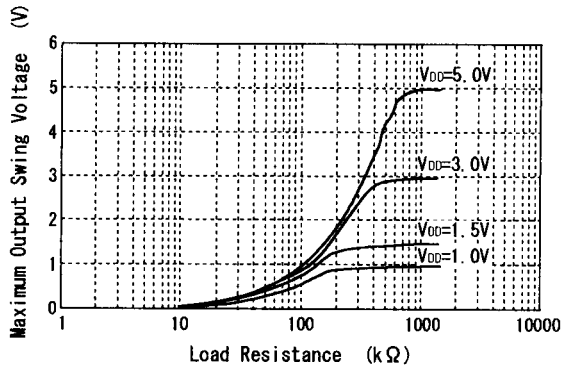

Maximum Output Swing Voltage vs. Frequency

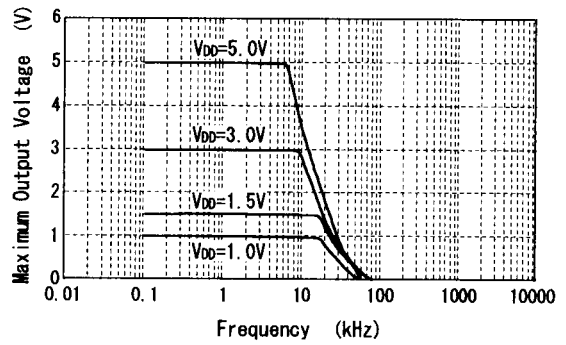

Voltage Gain-Phase vs. Frequency

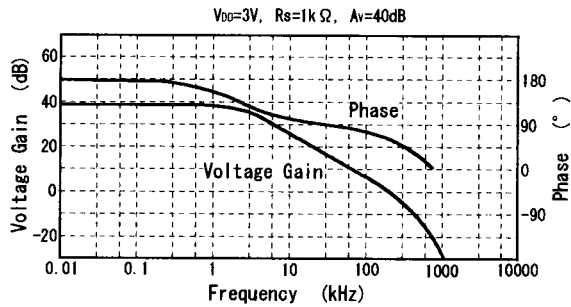

(2) NJU7015

Output Voltage vs. Output Current (SOURCE)

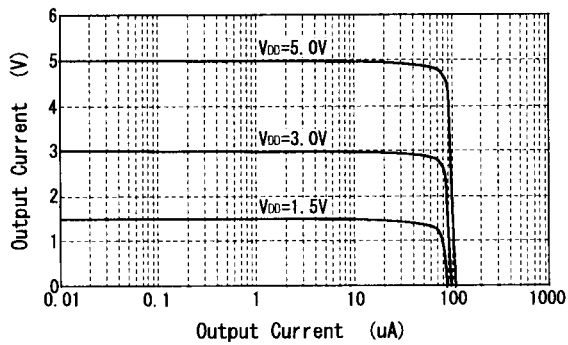

Output Voltage vs. Output Current (SINK)

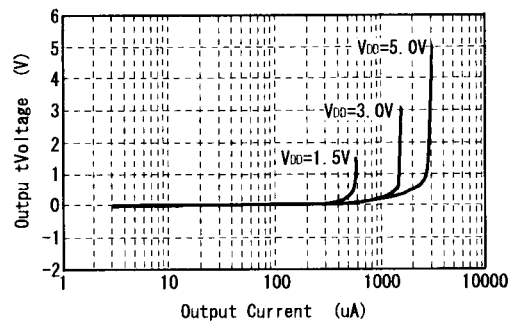

Operating Current vs. Operating Voltage

V_{IN}=0.1V

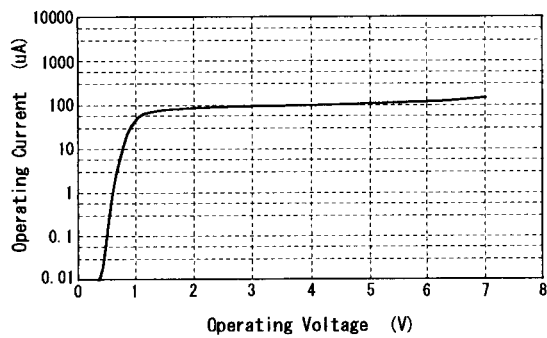

Output Current vs. Operating Voltage

V_{IN}=0.1V

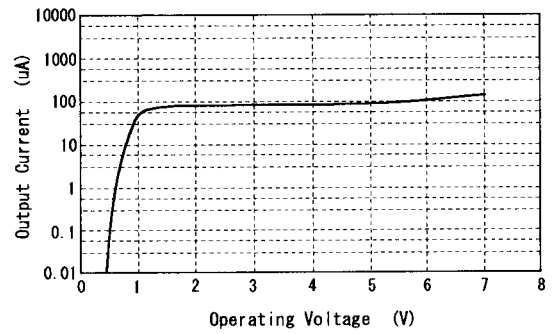

Maximum Output Swing Voltage vs. Load Resistance

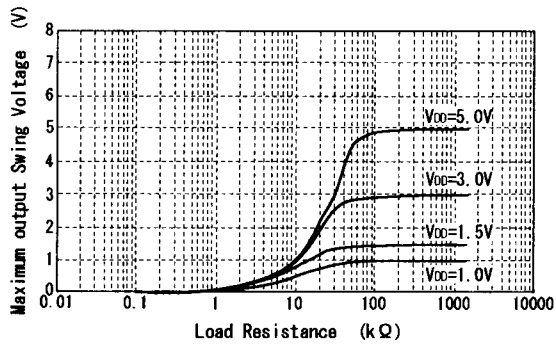

Maximum Output Swing Voltage vs. Frequency

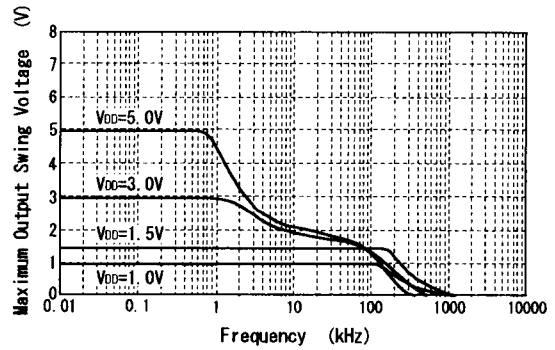

Voltage Gain-Phase vs. Frequency

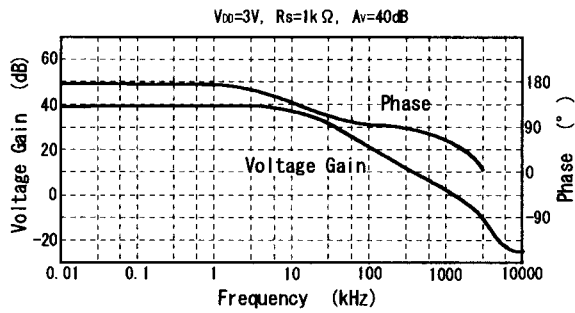

(3) NJU7016

Output Voltage vs. Output Current (SOURCE)

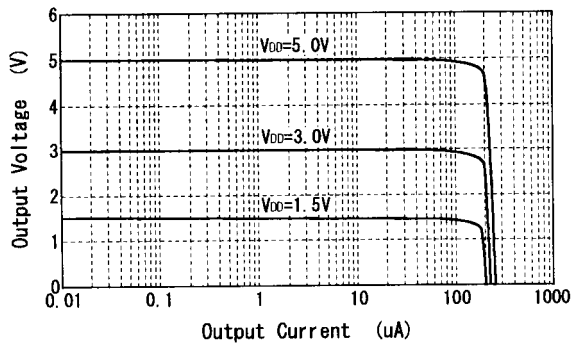

Output Voltage vs. Output Current (SINK)

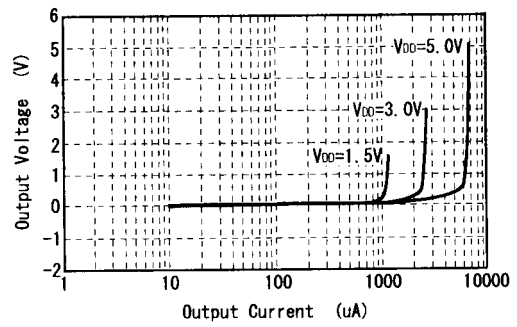

Operating Current vs. Operating Voltage

V_{IN}=0.1V

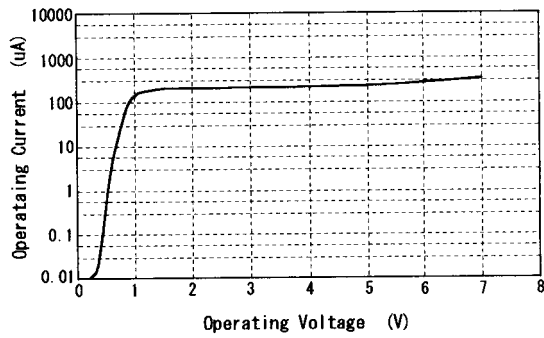

Output Current vs. Operating Voltage

V_{IN}=0.1V

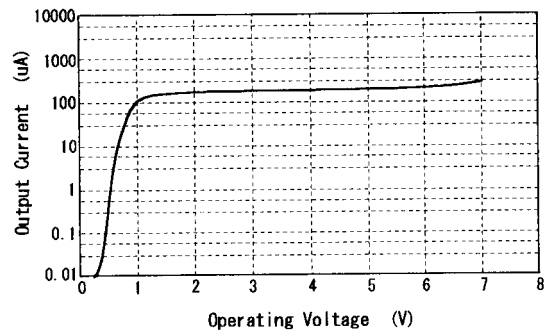

Maximum Output Swing Voltage vs. Load Resistance

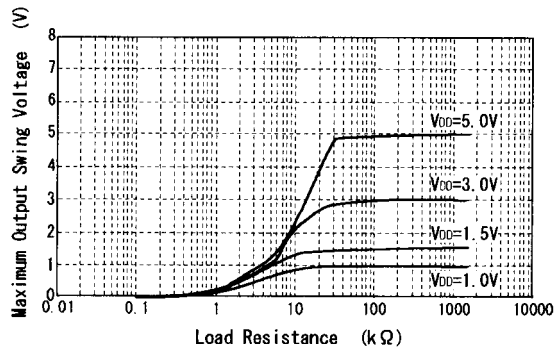

Maximum Output Swing Voltage vs. Frequency

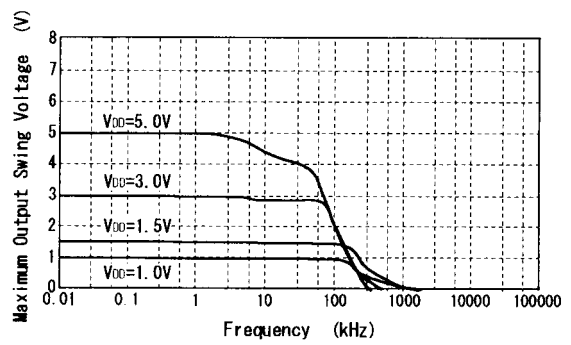

Voltage Gain·Phase vs. Frequency

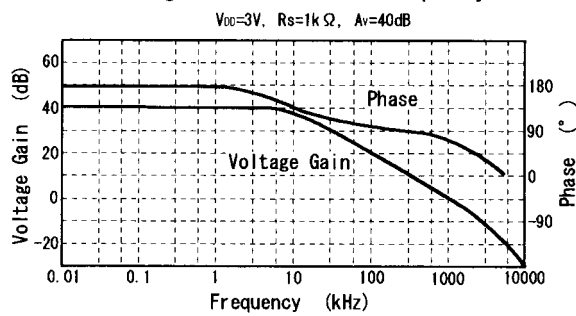

[CAUTION]

The specifications on this databook are only given for information, without any guarantee as regards either mistakes or omissions. The application circuits in this databook are described only to show representative usages of the product and not intended for the guarantee or permission of any right including the industrial rights.