

**12-CHARACTER 1-LINE  
DOT MATRIX LCD CONTROLLER DRIVER****■ GENERAL DESCRIPTION**

The NJU6467 is a Dot Matrix LCD controller driver for 12-character 1-line with icon display in single chip.

It contains CR oscillator, serial interface circuits, instruction decoder controller, character generator ROM/RAM, high voltage operation common and segment drivers.

The CR oscillator incorporates C and R, therefore no external components for oscillation are required.

The serial interface circuits which operate by 1MHz, can be connected directly to serial port of the micro-processor.

The character generator consists of 7,680 bits ROM and 32 x 5 bits RAM.

The 17-common ( 16 for character, 1 for icon ) and 30-segment drives up to 12-character 1-line, and the icon common driver display up to 24 icons.

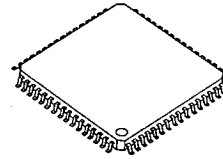
**■ PACKAGE OUTLINE****NJU6467F****■ FEATURES**

- 12-character 1-line Dot Matrix LCD Controller Driver
- Maximum 24 icon Display (Using COMMK)
- Serial interface with Microprocessor
- Display Data RAM - 12 x 8 bits : Maximum 12-character 1-line Display
- Character Generator ROM - 7,680 bits : 192 Characters for 5 x 7 Dots
- Character Generator RAM - 32 x 5 bits : 4 Patterns( 5 x 7 Dots )
- Icon Display RAM - 5 x 5 bits : 24 Icons
- High Voltage LCD Driver : 17-common / 30-segment
- Duty Ratio : 1/18 Duty
- Useful Instruction Set : Clear Display, Return Home, Display ON/OFF Cont, Cursor ON/OFF Cont, Display Blink, Cursor Shift, Character Shift
- Power On Initialize / Hardware Reset Function
- Oscillation Circuit On-chip
- Low Power Consumption -- ( 50 $\mu$ A MAX. )
- Operating Voltage --- 2.4 to 3.6 V ( Except LCD Driving Voltage )
- Package Outline --- QFP 64 / TQFP 64
- C-MOS Technology

■ PIN CONFIGURATION

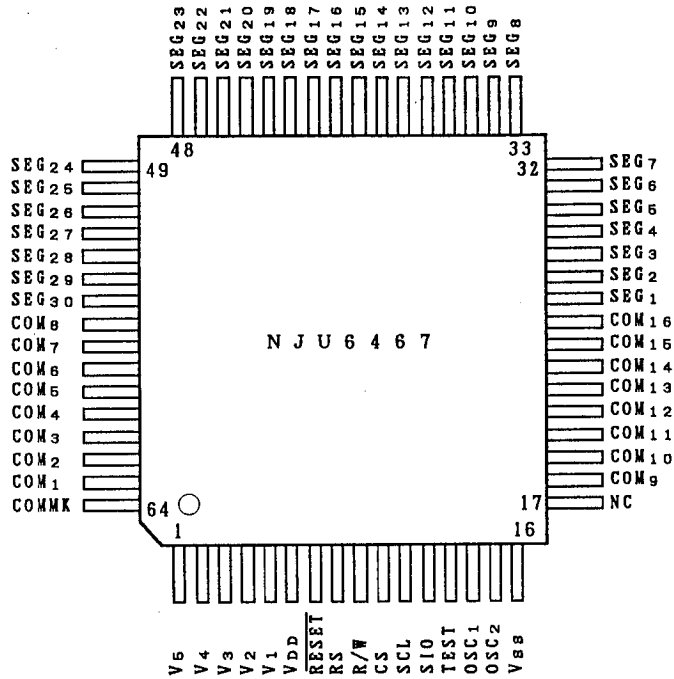

5

■ BLOCK DIAGRAM

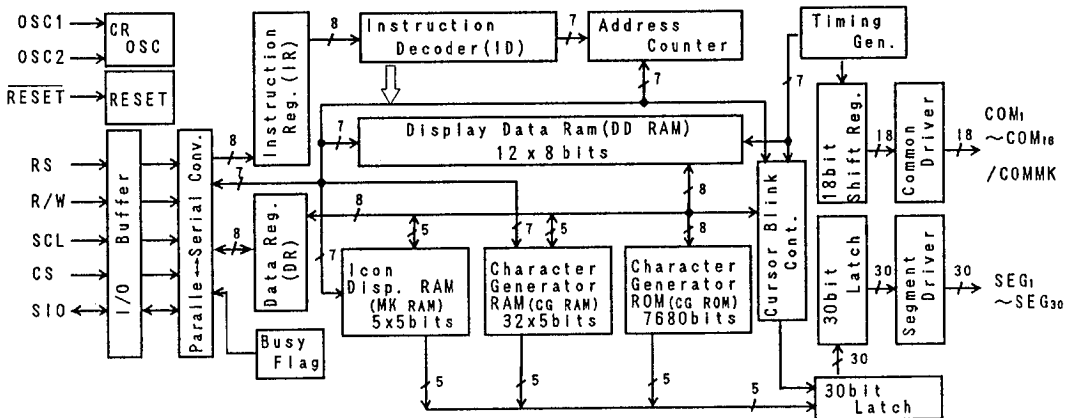

## ■ TERMINAL DESCRIPTION

PAD NO.	SYMBOL	F U N C T I O N
6	V <sub>DD</sub>	Power Source ( + 3V )
16	V <sub>SS</sub>	Power Source ( 0V )
1~5	V <sub>5</sub> ~V <sub>1</sub>	LCD Driving Voltage Output
14 15	OSC <sub>1</sub> OSC <sub>2</sub>	Oscillation Frequency Adjust Terminals. Normally open. (Oscillation C and R are incorporated, f <sub>osc</sub> =45kHz) For external clock operation, the clock should be input on OSC <sub>1</sub> .
8	RS	Register Selection Signal Input ( Pull-up Resistance On-chip ) "0" : Instruction Register ( Writing ) Busy Flag, Address Counter ( Reading ) "1" : Data Register ( Writing / Reading )
9	R/W	Read/Write Selection Signal Input ( Pull-up Resistance On-chip ) "0" : Write , "1" : Read
11	SCL	Shift Clock Input of Serial date transfer.
10	CS	Chip Select Signal Input of Serial date transfer.
12	SIO	Serial Data I/O of Serial date transfer.
56~63 18~25	COM <sub>6</sub> ~COM <sub>1</sub> COM <sub>9</sub> ~COM <sub>16</sub>	LCD Common Driving Signal output terminals.
64	COMMK	Icon Display Common Driving Signal output terminals.
26~55	SEG <sub>1</sub> ~SEG <sub>30</sub>	LCD Segment Driving Signal output terminals.
7	RESET	Reset Terminal. When the "L" level input over than 1.2ms to this terminal, the system will be reset ( f <sub>osc</sub> =45kHz ).
13	TEST	Maker testing terminal. Normally Open.
17	NC	Non connect.

**FUNCTIONAL DESCRIPTION**
**(1) Description for each blocks**
**(1-1) Register**

The NJU6467 incorporates two 8-bit registers, an Instruction Register (IR) and a Data Register (DR). The Register (IR) stores instruction codes such as "Clear Display" and "Return Home", and address data for Display Data RAM (DD RAM), Character Generator RAM (CG RAM) and Icon Display RAM (MK RAM).

The MPU can write the instruction code and address data to the Register (IR), but it cannot read out from the Register (IR).

The Register (DR) is a temporary stored register, the data stored in the Register (DR) is written into the DD RAM, CG RAM or MK RAM and read out from the DD RAM, CG RAM or MK RAM.

The data in the Register (DR) written by the MPU is transferred automatically to the DD RAM, CG RAM or MK RAM by internal operation.

When the address data for the DD RAM, CG RAM or MK RAM is written into the Register (IR), the addressed data in the DD RAM, CG RAM or MK RAM is transferred to the Register (DR). By the MPU read out the data in the Register (DR), the data transmitting process is performed completely.

After reading the data in the Register (DR) by the MPU, the next address data in the DD RAM, CG RAM or MK RAM is transferred automatically to the Register (DR) to provide for the next MPU reading.

These two registers are selected by the selection signal RS as shown below.

Table 1. shows register operation controlled by RS and R/W signals.

Table 1. Register Operation

RS	R/W	Selected Register	Operation
0	0	IR	Write
0	1		Read busy flag (DB <sub>7</sub> ) and address counter (DB <sub>0</sub> ~DB <sub>6</sub> )
1	0	DR	Write (Register (DR) to DD RAM, CG RAM or MK RAM)
1	1		Read (DD RAM, CG RAM or MK RAM to Register (DR))

**(1-2) Busy Flag (BF)**

When the internal circuits are in the operation mode, the busy flag (BF) is "1", and any instruction reading is inhibited.

The busy flag (BF) is output at DB<sub>7</sub> when RS="0" and R/W="1" as shown in Table 1.

The next instruction should be written after the busy flag (BF) goes to "0".

**(1-3) Address Counter (AC)**

The address counter (AC) addressing the DD RAM, CG RAM and MK RAM.

When the address setting instruction is written into the Register (IR), the address information is transferred from Register (IR) to Counter (AC). The selection of either the DD RAM, CG RAM or MK RAM is also determined by this instruction.

After writing (or reading) the display data to (or from) the DD RAM, CG RAM or MK RAM, the Counter (AC) increments (or decrements) automatically.

The address data in the Counter (AC) is output from DB<sub>6</sub>~DB<sub>0</sub> when RS="0" and R/W="1" as shown in Table 1.

### (1-4) Display Data RAM (DD RAM)

The display data RAM (DD RAM) consists of 12 x 8 bits stores up to 12-character display data represented in 8-bit code.

The DD RAM address data set in the address counter(AC) is represented in Hexadecimal.

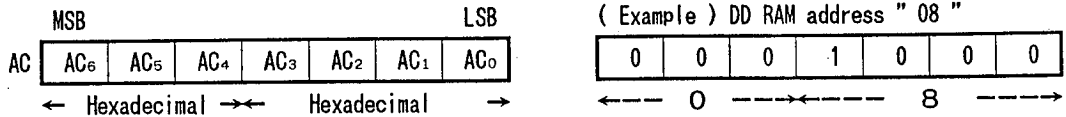

The relation between DD RAM address and display position on the LCD is shown below.

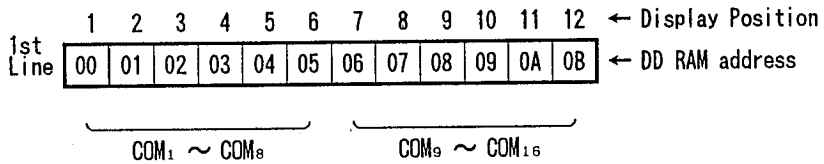

When the display shift is performed, the DD RAM address changes as follows:

( Left Shift Display )

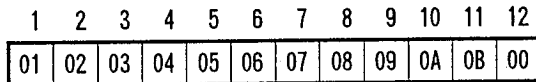

( Right Shift Display )

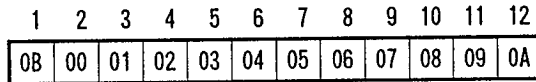

### (1-5) Character Generator ROM (CG ROM)

The Character Generator ROM (CG ROM) generates 5 x 7 dots character pattern represented in 8-bit character codes.

The storage capacity is up to 192 kinds of 5 x 7 dots character pattern.

The correspondence between character code and standard character pattern of NJU6467 is shown in Table 2.

User-defined character patterns (Custom Font) are also available by mask option.

Table 2. CG ROM Character Pattern ( ROM version -01 )

		Upper 4-bit ( Hexadecimal )															
		0	2	3	4	5	6	7			A	B	C	D	E	F	
Lower 4-bit ( Hexadecimal )	0 (01)	CG RAM (01)			0	a	P	`	P				—	9	E	0	p
	1 (02)		!	1	A	Q	a	q				=	7	7	6	8	q
	2 (03)		"	2	B	R	b	r				r	4	w	x	8	8
	3 (04)		#	3	C	S	c	s				j	0	7	7	8	w
	4 (01)		\$	4	D	T	d	t				\	I	T	7	w	0
	5 (02)		%	5	E	U	e	u				.	+	+	1	0	0
	6 (03)		&	6	F	V	f	v				7	0	2	3	p	2
	7 (04)		'	7	G	W	g	w				7	+	7	7	9	π
	8 (01)		(	8	H	X	h	x				4	0	7	U	J	X
	9 (02)		)	9	I	Y	i	y				9	7	J	w	"	y
	A (03)		*	:	J	Z	j	z				π	0	0	0	J	7
	B (04)		+	:	K	L	k	l				7	7	0	0	7	π
	C (01)		,	<	L	#	l	l				7	0	7	7	0	π
	D (02)		—	=	M	0	m	0				π	7	0	0	0	+
	E (03)		.	>	N	^	n	+				3	0	7	7	π	
	F (04)		/	?	O	_	o	+				w	U	7	7	0	π

 Character code (1X)<sub>H</sub>, (8X)<sub>H</sub>, (9X)<sub>H</sub> don't exist.

## (1-6) Character Generator RAM (CG RAM)

The character generator RAM (CG RAM) can store any kind of character pattern in 5 x 7 dots written by the user program to display user's original character pattern and icon data. The CG RAM can store 4 kind of character in 5 x 7 dots mode or 2 kind of character in 5 x 7 dots mode and icon data.

To display user's original character pattern stored in the CG RAM, the address data (00)<sub>H</sub> - (03)<sub>H</sub> should be written to the DD RAM as shown in Table 2.

Table 3. show the correspondence among the character pattern, CG RAM address and Data.

Table 3. Correspondence of CG RAM address, DD RAM character code and CG RAM character pattern( 5 x 7 dots ).

Character Code (DD RAM Data)		CG RAM Address		Character Pattern (CG RAM Data)																																																																	
7 6 5 4 3 2 1 0		5 4 3 2 1 0		7 6 5 4 3 2 1 0																																																																	
Upperbit Lowerbit		Upper	Lower	Upperbit	Lowerbit																																																																
0 0 0 0 * 0 0 0		0 0 0	0 0 0	***	<table border="1"> <tr><td>0</td><td>0</td><td>0</td><td>0</td><td>0</td><td>0</td><td>0</td><td>0</td></tr> <tr><td>0</td><td>0</td><td>0</td><td>0</td><td>0</td><td>0</td><td>0</td><td>0</td></tr> <tr><td>0</td><td>0</td><td>0</td><td>0</td><td>0</td><td>0</td><td>0</td><td>0</td></tr> <tr><td>0</td><td>0</td><td>0</td><td>0</td><td>0</td><td>0</td><td>0</td><td>0</td></tr> <tr><td>0</td><td>0</td><td>0</td><td>0</td><td>0</td><td>0</td><td>0</td><td>0</td></tr> <tr><td>0</td><td>0</td><td>0</td><td>0</td><td>0</td><td>0</td><td>0</td><td>0</td></tr> <tr><td>0</td><td>0</td><td>0</td><td>0</td><td>0</td><td>0</td><td>0</td><td>0</td></tr> <tr><td>0</td><td>0</td><td>0</td><td>0</td><td>0</td><td>0</td><td>0</td><td>0</td></tr> </table>	0	0	0	0	0	0	0	0	0	0	0	0	0	0	0	0	0	0	0	0	0	0	0	0	0	0	0	0	0	0	0	0	0	0	0	0	0	0	0	0	0	0	0	0	0	0	0	0	0	0	0	0	0	0	0	0	0	0	0	0	0	0	0	0
0	0	0	0	0	0	0	0																																																														
0	0	0	0	0	0	0	0																																																														
0	0	0	0	0	0	0	0																																																														
0	0	0	0	0	0	0	0																																																														
0	0	0	0	0	0	0	0																																																														
0	0	0	0	0	0	0	0																																																														
0	0	0	0	0	0	0	0																																																														
0	0	0	0	0	0	0	0																																																														
			0 0 1	***	<table border="1"> <tr><td>0</td><td>0</td><td>0</td><td>0</td><td>0</td><td>0</td><td>0</td><td>0</td></tr> <tr><td>0</td><td>0</td><td>0</td><td>0</td><td>0</td><td>0</td><td>0</td><td>0</td></tr> <tr><td>0</td><td>0</td><td>0</td><td>0</td><td>0</td><td>0</td><td>0</td><td>0</td></tr> <tr><td>0</td><td>0</td><td>0</td><td>0</td><td>0</td><td>0</td><td>0</td><td>0</td></tr> <tr><td>0</td><td>0</td><td>0</td><td>0</td><td>0</td><td>0</td><td>0</td><td>0</td></tr> <tr><td>0</td><td>0</td><td>0</td><td>0</td><td>0</td><td>0</td><td>0</td><td>0</td></tr> <tr><td>0</td><td>0</td><td>0</td><td>0</td><td>0</td><td>0</td><td>0</td><td>0</td></tr> <tr><td>0</td><td>0</td><td>0</td><td>0</td><td>0</td><td>0</td><td>0</td><td>0</td></tr> </table>	0	0	0	0	0	0	0	0	0	0	0	0	0	0	0	0	0	0	0	0	0	0	0	0	0	0	0	0	0	0	0	0	0	0	0	0	0	0	0	0	0	0	0	0	0	0	0	0	0	0	0	0	0	0	0	0	0	0	0	0	0	0	0	0
0	0	0	0	0	0	0	0																																																														
0	0	0	0	0	0	0	0																																																														
0	0	0	0	0	0	0	0																																																														
0	0	0	0	0	0	0	0																																																														
0	0	0	0	0	0	0	0																																																														
0	0	0	0	0	0	0	0																																																														
0	0	0	0	0	0	0	0																																																														
0	0	0	0	0	0	0	0																																																														
			0 0 0	***	<table border="1"> <tr><td>0</td><td>0</td><td>0</td><td>0</td><td>0</td><td>0</td><td>0</td><td>0</td></tr> <tr><td>0</td><td>0</td><td>0</td><td>0</td><td>0</td><td>0</td><td>0</td><td>0</td></tr> <tr><td>0</td><td>0</td><td>0</td><td>0</td><td>0</td><td>0</td><td>0</td><td>0</td></tr> <tr><td>0</td><td>0</td><td>0</td><td>0</td><td>0</td><td>0</td><td>0</td><td>0</td></tr> <tr><td>0</td><td>0</td><td>0</td><td>0</td><td>0</td><td>0</td><td>0</td><td>0</td></tr> <tr><td>0</td><td>0</td><td>0</td><td>0</td><td>0</td><td>0</td><td>0</td><td>0</td></tr> <tr><td>0</td><td>0</td><td>0</td><td>0</td><td>0</td><td>0</td><td>0</td><td>0</td></tr> <tr><td>0</td><td>0</td><td>0</td><td>0</td><td>0</td><td>0</td><td>0</td><td>0</td></tr> </table>	0	0	0	0	0	0	0	0	0	0	0	0	0	0	0	0	0	0	0	0	0	0	0	0	0	0	0	0	0	0	0	0	0	0	0	0	0	0	0	0	0	0	0	0	0	0	0	0	0	0	0	0	0	0	0	0	0	0	0	0	0	0	0	0
0	0	0	0	0	0	0	0																																																														
0	0	0	0	0	0	0	0																																																														
0	0	0	0	0	0	0	0																																																														
0	0	0	0	0	0	0	0																																																														
0	0	0	0	0	0	0	0																																																														
0	0	0	0	0	0	0	0																																																														
0	0	0	0	0	0	0	0																																																														
0	0	0	0	0	0	0	0																																																														
			0 0 1	***	<table border="1"> <tr><td>0</td><td>0</td><td>0</td><td>0</td><td>0</td><td>0</td><td>0</td><td>0</td></tr> <tr><td>0</td><td>0</td><td>0</td><td>0</td><td>0</td><td>0</td><td>0</td><td>0</td></tr> <tr><td>0</td><td>0</td><td>0</td><td>0</td><td>0</td><td>0</td><td>0</td><td>0</td></tr> <tr><td>0</td><td>0</td><td>0</td><td>0</td><td>0</td><td>0</td><td>0</td><td>0</td></tr> <tr><td>0</td><td>0</td><td>0</td><td>0</td><td>0</td><td>0</td><td>0</td><td>0</td></tr> <tr><td>0</td><td>0</td><td>0</td><td>0</td><td>0</td><td>0</td><td>0</td><td>0</td></tr> <tr><td>0</td><td>0</td><td>0</td><td>0</td><td>0</td><td>0</td><td>0</td><td>0</td></tr> <tr><td>0</td><td>0</td><td>0</td><td>0</td><td>0</td><td>0</td><td>0</td><td>0</td></tr> </table>	0	0	0	0	0	0	0	0	0	0	0	0	0	0	0	0	0	0	0	0	0	0	0	0	0	0	0	0	0	0	0	0	0	0	0	0	0	0	0	0	0	0	0	0	0	0	0	0	0	0	0	0	0	0	0	0	0	0	0	0	0	0	0	0
0	0	0	0	0	0	0	0																																																														
0	0	0	0	0	0	0	0																																																														
0	0	0	0	0	0	0	0																																																														
0	0	0	0	0	0	0	0																																																														
0	0	0	0	0	0	0	0																																																														
0	0	0	0	0	0	0	0																																																														
0	0	0	0	0	0	0	0																																																														
0	0	0	0	0	0	0	0																																																														
			0 0 0	***	<table border="1"> <tr><td>0</td><td>0</td><td>0</td><td>0</td><td>0</td><td>0</td><td>0</td><td>0</td></tr> <tr><td>0</td><td>0</td><td>0</td><td>0</td><td>0</td><td>0</td><td>0</td><td>0</td></tr> <tr><td>0</td><td>0</td><td>0</td><td>0</td><td>0</td><td>0</td><td>0</td><td>0</td></tr> <tr><td>0</td><td>0</td><td>0</td><td>0</td><td>0</td><td>0</td><td>0</td><td>0</td></tr> <tr><td>0</td><td>0</td><td>0</td><td>0</td><td>0</td><td>0</td><td>0</td><td>0</td></tr> <tr><td>0</td><td>0</td><td>0</td><td>0</td><td>0</td><td>0</td><td>0</td><td>0</td></tr> <tr><td>0</td><td>0</td><td>0</td><td>0</td><td>0</td><td>0</td><td>0</td><td>0</td></tr> <tr><td>0</td><td>0</td><td>0</td><td>0</td><td>0</td><td>0</td><td>0</td><td>0</td></tr> </table>	0	0	0	0	0	0	0	0	0	0	0	0	0	0	0	0	0	0	0	0	0	0	0	0	0	0	0	0	0	0	0	0	0	0	0	0	0	0	0	0	0	0	0	0	0	0	0	0	0	0	0	0	0	0	0	0	0	0	0	0	0	0	0	0
0	0	0	0	0	0	0	0																																																														
0	0	0	0	0	0	0	0																																																														
0	0	0	0	0	0	0	0																																																														
0	0	0	0	0	0	0	0																																																														
0	0	0	0	0	0	0	0																																																														
0	0	0	0	0	0	0	0																																																														
0	0	0	0	0	0	0	0																																																														
0	0	0	0	0	0	0	0																																																														
			0 0 1	***	<table border="1"> <tr><td>0</td><td>0</td><td>0</td><td>0</td><td>0</td><td>0</td><td>0</td><td>0</td></tr> <tr><td>0</td><td>0</td><td>0</td><td>0</td><td>0</td><td>0</td><td>0</td><td>0</td></tr> <tr><td>0</td><td>0</td><td>0</td><td>0</td><td>0</td><td>0</td><td>0</td><td>0</td></tr> <tr><td>0</td><td>0</td><td>0</td><td>0</td><td>0</td><td>0</td><td>0</td><td>0</td></tr> <tr><td>0</td><td>0</td><td>0</td><td>0</td><td>0</td><td>0</td><td>0</td><td>0</td></tr> <tr><td>0</td><td>0</td><td>0</td><td>0</td><td>0</td><td>0</td><td>0</td><td>0</td></tr> <tr><td>0</td><td>0</td><td>0</td><td>0</td><td>0</td><td>0</td><td>0</td><td>0</td></tr> <tr><td>0</td><td>0</td><td>0</td><td>0</td><td>0</td><td>0</td><td>0</td><td>0</td></tr> </table>	0	0	0	0	0	0	0	0	0	0	0	0	0	0	0	0	0	0	0	0	0	0	0	0	0	0	0	0	0	0	0	0	0	0	0	0	0	0	0	0	0	0	0	0	0	0	0	0	0	0	0	0	0	0	0	0	0	0	0	0	0	0	0	0
0	0	0	0	0	0	0	0																																																														
0	0	0	0	0	0	0	0																																																														
0	0	0	0	0	0	0	0																																																														
0	0	0	0	0	0	0	0																																																														
0	0	0	0	0	0	0	0																																																														
0	0	0	0	0	0	0	0																																																														
0	0	0	0	0	0	0	0																																																														
0	0	0	0	0	0	0	0																																																														
			1 1 1	***	<table border="1"> <tr><td>0</td><td>0</td><td>0</td><td>0</td><td>0</td><td>0</td><td>0</td><td>0</td></tr> <tr><td>0</td><td>0</td><td>0</td><td>0</td><td>0</td><td>0</td><td>0</td><td>0</td></tr> <tr><td>0</td><td>0</td><td>0</td><td>0</td><td>0</td><td>0</td><td>0</td><td>0</td></tr> <tr><td>0</td><td>0</td><td>0</td><td>0</td><td>0</td><td>0</td><td>0</td><td>0</td></tr> <tr><td>0</td><td>0</td><td>0</td><td>0</td><td>0</td><td>0</td><td>0</td><td>0</td></tr> <tr><td>0</td><td>0</td><td>0</td><td>0</td><td>0</td><td>0</td><td>0</td><td>0</td></tr> <tr><td>0</td><td>0</td><td>0</td><td>0</td><td>0</td><td>0</td><td>0</td><td>0</td></tr> <tr><td>0</td><td>0</td><td>0</td><td>0</td><td>0</td><td>0</td><td>0</td><td>0</td></tr> </table>	0	0	0	0	0	0	0	0	0	0	0	0	0	0	0	0	0	0	0	0	0	0	0	0	0	0	0	0	0	0	0	0	0	0	0	0	0	0	0	0	0	0	0	0	0	0	0	0	0	0	0	0	0	0	0	0	0	0	0	0	0	0	0	0
0	0	0	0	0	0	0	0																																																														
0	0	0	0	0	0	0	0																																																														
0	0	0	0	0	0	0	0																																																														
0	0	0	0	0	0	0	0																																																														
0	0	0	0	0	0	0	0																																																														
0	0	0	0	0	0	0	0																																																														
0	0	0	0	0	0	0	0																																																														
0	0	0	0	0	0	0	0																																																														

\* : Don't Care

- Notes :
- Character code bit 0, 1 correspond to the CG RAM address 3, 4(2bits:4 patterns).
  - CG RAM address 0 to 2 designate character pattern line position. The 8th line is the cursor position and the display is performed by logical OR with cursor. Therefore, in case of the cursor display, the 8th line should be "0". If there is "1" in the 8th line, the bit "1" is always displayed on the cursor position regardless of cursor existence.
  - Character pattern row position correspond to the CG RAM data bits 0 to 4 are shown above.
  - CG RAM character patterns are selected when character code bits 4 to 7 are all "0" and it is addressed by character code bits 0 and 1. Therefore, the address (00)<sub>H</sub>, (04)<sub>H</sub>, (08)<sub>H</sub> and (0C)<sub>H</sub> select the same character pattern as shown in Table 2.
  - "1" for CG RAM data corresponds to display On and "0" to display Off.

(1-7) Icon Display RAM (MK RAM)

The NJU6467 can display not only 5 x 7 bits character pattern but also maximum 24 icons.

The icon can be displayed by writing bit "1" to each data bit 0 to 4 in the address from (60)<sub>H</sub> to (64)<sub>H</sub> of MK RAM.

The icon display data is not affected except MK RAM writing and display ON/OFF instruction.

The relation between MK RAM address and icon display position on the LCD is fixed even if the display shift is executed. The relation is shown below:

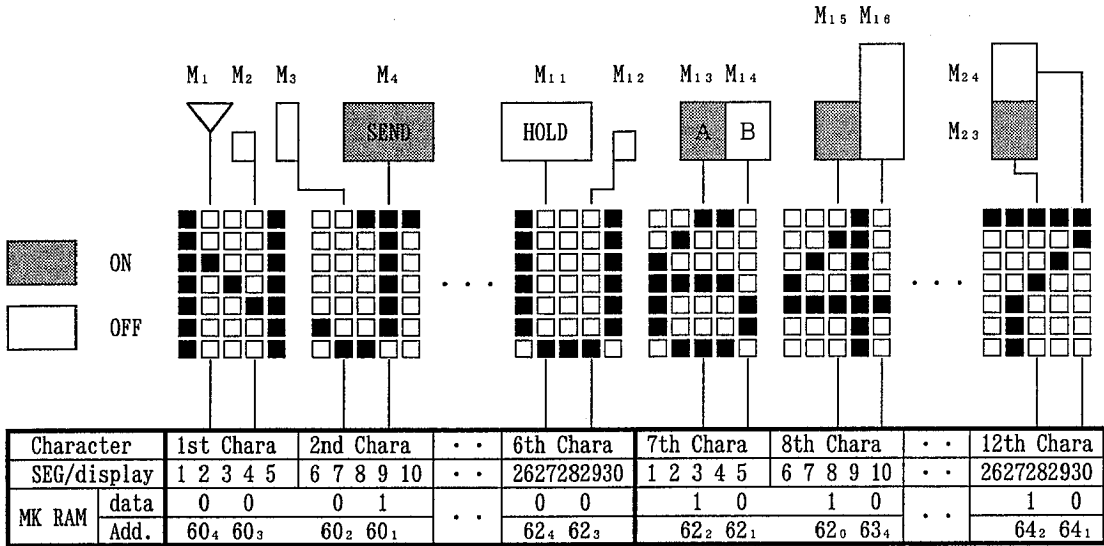

NOTE: The 60<sub>4</sub> corresponds bit 4 of (60)<sub>H</sub> in MK RAM.

Segment terminal number corresponding to the icon display position

	Segment Terminal No.
Above the 1st to 6th Character	2 4 7 9 12 14 17 19 22 24 27 29
Above the 7th to 12th Character	3 5 8 10 13 15 18 20 23 25 28 30

MK RAM address and data corresponding to the icon display position

MK RAM address	bits for icon display position							
	DB <sub>7</sub>	DB <sub>6</sub>	DB <sub>5</sub>	DB <sub>4</sub>	DB <sub>3</sub>	DB <sub>2</sub>	DB <sub>1</sub>	DB <sub>0</sub>
60 <sub>H</sub>	*	*	*	M <sub>1</sub>	M <sub>2</sub>	M <sub>3</sub>	M <sub>4</sub>	M <sub>5</sub>
61 <sub>H</sub>	*	*	*	M <sub>6</sub>	M <sub>7</sub>	M <sub>8</sub>	M <sub>9</sub>	M <sub>10</sub>
62 <sub>H</sub>	*	*	*	M <sub>11</sub>	M <sub>12</sub>	M <sub>13</sub>	M <sub>14</sub>	M <sub>15</sub>
63 <sub>H</sub>	*	*	*	M <sub>16</sub>	M <sub>17</sub>	M <sub>18</sub>	M <sub>19</sub>	M <sub>20</sub>
64 <sub>H</sub>	*	*	*	M <sub>21</sub>	M <sub>22</sub>	M <sub>23</sub>	M <sub>24</sub>	*

NOTE: When the icon display function using, the system should be initialized by the software initialization because of the MK RAM does not initialize except the software initialization.



### (1-8) Timing Generator

The timing generator generates a timing signals for the DD RAM, CG RAM, MK RAM and other internal circuits operation.

RAM read timing for the display and internal operation timing for MPU access are separately generated, so that they may not interfere with each other.

Therefore, when the data write to the DD RAM for example, there will be no undesirable influence, such as flickering, in areas other than the display area.

### (1-9) LCD Driver

LCD driver consist of 17-common driver and 30-segment driver.

When the line number is selected by a program, the required common drivers output the common driving waveform and the other common drivers output non-selection waveform automatically.

The 30 bits of character pattern data are shifted in the shift-register and latched when the 30 bits shift performed completely. This latched data controls display driver to output LCD driving waveform.

### (1-10) Cursor Blinking Control Circuit

This circuits controls cursor On/Off and the cursor position character blinks.

The cursor or blinks appear in the digit residing at the DD RAM address set in the address counter (AC).

When the address counter is (08)<sub>16</sub>, a cursor position is shown as follows:

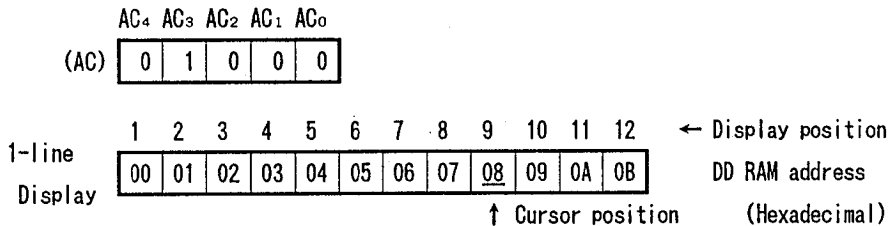

Note: The cursor or blinks also appear when the address counter (AC) selects the CG RAM.

But the displayed cursor and blink are meaningless.

If the AC storing the CG RAM address data, the cursor and blink are displayed in the meaningless position.

**(2) Power on Initialization by internal circuits**

**(2-1) Initialization By Internal Reset Circuits**

The NJU6467 is automatically initialized by internal power on initialization circuits when the power is turned on. In the internal power on initialization, following instructions are executed. During the Internal power on initialization, the busy flag (BF) is "1" and this status is kept 10 ms after  $V_{DD}$  rises to 2.4V.

Initialization flow is shown below:

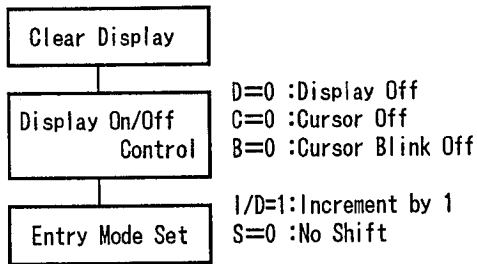

**NOTE**  
 If the condition of power supply rise time described in the Electrical Characteristics is not satisfied, the internal Power On Initialization Circuits will not operated and initialization will not performed. In this case the initialization by MPU software is required.

**(2-2) Initialization By Hardware**

The NJU6467 incorporates RESET terminal to initialize the all system. When the "L" level input over than 1.2ms to the RESET terminal, reset sequence is executed. In this time, busy signal output during 10ms after RESET terminal goes to "H".

•Reset Circuit

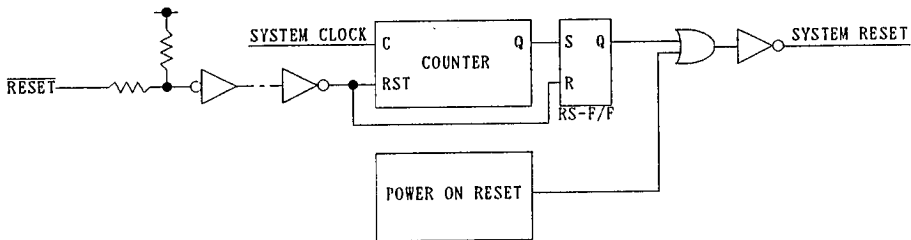

•Timing Chart

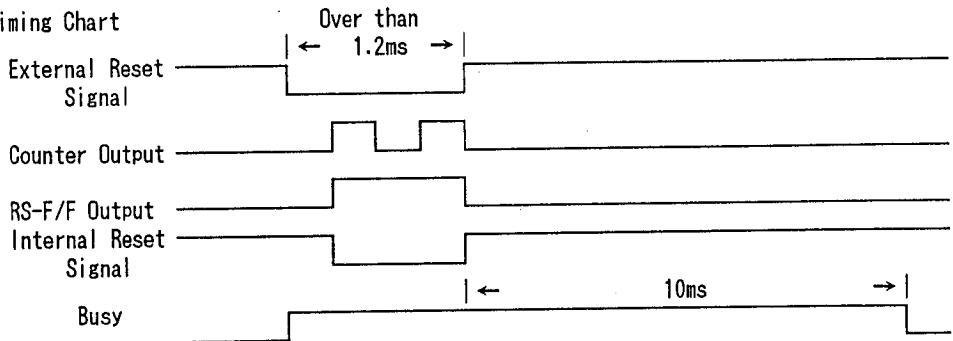

**5**

## (3) Instructions

The NJU6467 incorporates two registers, an Instruction Register (IR) and a Data Register (DR). These two registers store control information temporarily to allow interface between NJU6467 and MPU or peripheral ICs operating different cycles. The operation of NJU6467 is determined by this control signal from MPU. The control information includes register selection signals (RS), read/write signals (R/W) and data I/O signals (DB<sub>0</sub> to DB<sub>7</sub> by SIO terminal).

Table 4. Table of Instructions

INSTRUCTIONS	C O D E										DESCRIPTION	EXEC TIME	
	RS	R/W	DB <sub>7</sub>	DB <sub>6</sub>	DB <sub>5</sub>	DB <sub>4</sub>	DB <sub>3</sub>	DB <sub>2</sub>	DB <sub>1</sub>	DB <sub>0</sub>			
Maker Testing	0	0	0	0	0	0	0	0	0	0	All "0" code is using for maker testing.	-	
Clear Display	0	0	0	0	0	0	0	0	0	1	Display clear and sets DD RAM address 0 in AC.	2.89ms	
Return Home	0	0	0	0	0	0	0	0	1	*	Sets DD RAM address 0 in AC and returns display being shifted to original position. DD RAM contents remain unchanged	223us	
Entry Mode Set	0	0	0	0	0	0	0	1	I/D	S	Sets cursor move direction and specifies shift of display are performed in data read/write. I/D=1: Increment, I/D=0: Decrement S=1: Accompanies display shift	223us	
Display On/Off Control	0	0	0	0	0	0	1	D	C	B	Sets of display On/Off(D), cursor On/Off(C) and blink of cursor position character(B).	223us	
Cursor or Display Shift	0	0	0	0	0	1	S/C	R/L	*	*	Moves cursor and shifts display without changing DD RAM contents S/C=1 : Display shift S/C=0 : Cursor shift R/L=1 : Shift to the right R/L=0 : Shift to the left	312us	
Non Operation	0	0	0	0	1	*	*	*	*	*	Non operation.	-	
Set RAM Address	0	0	0	1	*	*	*	*	*	*	Sets DD RAM, CG RAM and MK RAM address.	223us	
Read Busy Flag & Address	0	1	BF	←←←	AC	→→→					Reads busy flag and AC contents. BF=1 : Internally operating BF=0 : Can accept instruction	0us	
Write Data to CG & DD RAM	1	0	←← Write Data (DD RAM) →→					← Write Data →			Writes data into DD, CG or MK RAMs	223us	
	1	0	* * *					← Write Data →					
	1	0	* * *					← Write Data →					
Read Data from CG or DD RAM	1	1	←← Read Data (DD RAM) →→					← Read Data →			Reads data from DD, CG or MK RAMs	312us	
	1	1	* * *					← Read Data →					
	1	1	* * *					← Read Data →					
Explanation of Abbreviation	DD RAM : Display data RAM , CG RAM : Character generator RAM MK RAM : Icon Display RAM AC : Address counter used for both of DD, CG and MK RAMs												

\* = Don't care

5

## (3-1) Description of each instructions

## (a) Maker Testing

	RS	R/W	DB <sub>7</sub>	DB <sub>6</sub>	DB <sub>5</sub>	DB <sub>4</sub>	DB <sub>3</sub>	DB <sub>2</sub>	DB <sub>1</sub>	DB <sub>0</sub>
Code	0	0	0	0	0	0	0	0	0	0

All "0" code writing twice is using for device testing mode ( only for maker ). Therefore, please do not normally use this instruction.

## (b) Clear Display

	RS	R/W	DB <sub>7</sub>	DB <sub>6</sub>	DB <sub>5</sub>	DB <sub>4</sub>	DB <sub>3</sub>	DB <sub>2</sub>	DB <sub>1</sub>	DB <sub>0</sub>
Code	0	0	0	0	0	0	0	0	0	1

Clear display instruction is executed when the code "1" is written into DB<sub>0</sub>. When this instruction is executed, the space code (20)<sub>H</sub> is written into every DD RAM address, the DD RAM address 0 is set into the address counter and entry mode is set increment.

If the cursor or blink are displayed, they are returned to the left end of the LCD.

The S of entry mode does not change, the contents of CG RAM and MK RAM do not change either.

Note: The character pattern for character code (20)<sub>H</sub> must be blank code in the user-defined character pattern(Custom font).

## (c) Return Home

	RS	R/W	DB <sub>7</sub>	DB <sub>6</sub>	DB <sub>5</sub>	DB <sub>4</sub>	DB <sub>3</sub>	DB <sub>2</sub>	DB <sub>1</sub>	DB <sub>0</sub>	
Code	0	0	0	0	0	0	0	0	1	*	* = Don't care

Return home instruction is executed when the code "1" is written into DB<sub>1</sub>. When this instruction is executed, the DD RAM address 0 is set into the address counter. Display is returned its original position if shifted, the cursor or blink are returned to the left end of the LCD, if the cursor or blink are on the display.

The DD RAM contents do not change.

## (d) Entry Mode Set

	RS	R/W	DB <sub>7</sub>	DB <sub>6</sub>	DB <sub>5</sub>	DB <sub>4</sub>	DB <sub>3</sub>	DB <sub>2</sub>	DB <sub>1</sub>	DB <sub>0</sub>
Code	0	0	0	0	0	0	0	1	I/D	S

Entry mode set instruction which sets the cursor moving direction and display shift On/Off, is executed when the code "1" is written into DB<sub>2</sub> and the codes of (I/D) and (S) are written into DB<sub>1</sub>(I/D) and DB<sub>0</sub>(S), as shown below.

(I/D) sets the address increment or decrement, and the (S) sets the entire display shift in the DD RAM writing.

I/D	F u n c t i o n
1	Address increment: The address of the DD RAM, CG RAM or MK RAM increment (+1) when the read/write, and the cursor or blink move to the right.
0	Address decrement: The address of the DD RAM, CG RAM or MK RAM decrement (-1) when the read/write, and the cursor or blink move to the left.
S	F u n c t i o n
1	Entire display shift. The shift direction is determined by I/D.: shift to the left at I/D=1 and shift to the right at the I/D=0. The shift is operated only for the character, so that it looks as if the cursor stands still and the display moves. The display does not shift when reading from the DD RAM and writing/reading into/from CG RAM.
0	The display does not shifting.

## (e) Display On/Off Control

	RS	R/W	DB <sub>7</sub>	DB <sub>6</sub>	DB <sub>5</sub>	DB <sub>4</sub>	DB <sub>3</sub>	DB <sub>2</sub>	DB <sub>1</sub>	DB <sub>0</sub>
Code	0	0	0	0	0	0	1	D	C	B

The Display On/Off control instruction which controls the whole display On/Off, the cursor On/Off and the cursor position character blink, is executed when the code "1" is written into DB<sub>3</sub> and the codes of (D), (C) and (B) are written into DB<sub>2</sub>(D), DB<sub>1</sub>(C) and DB<sub>0</sub>(B), as shown below.

D	F u n c t i o n
1	Display On.
0	Display Off. In this mode, the display data remains in the DD RAM so that it is retrieved immediately on the display when the D change to 1.

C	F u n c t i o n
1	Cursor On. The cursor is displayed by 5 dots on the 8th line.
0	Cursor Off. Even if the display data write, the I/D etc does not change.

B	F u n c t i o n
1	The cursor position character is blinking. Blinking rate is 540ms at $f_{osc}=45kHz$ for 12-character 1-line. The cursor and the blink can be displayed simultaneously.
0	The character does not blink.

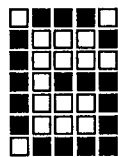

Cursor

Character Font 5 x 7 dots

(1) Cursor display example

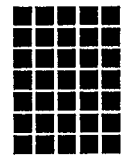
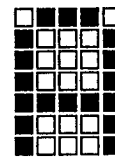

Alternating display

(2) Blink display example

## (f) Cursor/Display Shift

	RS	R/W	DB <sub>7</sub>	DB <sub>6</sub>	DB <sub>5</sub>	DB <sub>4</sub>	DB <sub>3</sub>	DB <sub>2</sub>	DB <sub>1</sub>	DB <sub>0</sub>	
Code	0	0	0	0	0	1	S/C	R/L	*	*	* = Don't care

Cursor/Display shift instruction shifts the cursor position or display to the right or left without writing or reading display data. This function is used to correct or search the display.

The contents of address counter(AC) does not change by operation of the display shift only.

This instruction is executed when the code "1" is written into DB<sub>4</sub> and the codes of (S/C) and (R/L) are written into DB<sub>3</sub>(S/C) and DB<sub>2</sub>(R/L) as shown below.

S/C	R/L	F u n c t i o n
0	0	Shifts the cursor position to the left ((AC) is decremented by 1)
0	1	Shifts the cursor position to the right ((AC) is incremented by 1)
1	0	Shifts the entire display to the left and the cursor follows it.
1	1	Shifts the entire display to the right and the cursor follows it.

## (g) Set RAM Address

	RS	R/W	DB <sub>7</sub>	DB <sub>6</sub>	DB <sub>5</sub>	DB <sub>4</sub>	DB <sub>3</sub>	DB <sub>2</sub>	DB <sub>1</sub>	DB <sub>0</sub>	
Code	0	0	1			A D D R E S S					
						←Higher order bit					Lower order bit→

Set RAM address instruction is set the address data written to DD RAM, CG RAM and MK RAM to the address counter (AC). After this instruction execution, the writing/reading is performed into/from the RAM written.

## RAM Address

DD RAM	1st Line	:	from (00) <sub>H</sub>	to (0B) <sub>H</sub>
CG RAM	4 characters	:	from (40) <sub>H</sub>	to (5F) <sub>H</sub>
MK RAM	24 icons	:	from (60) <sub>H</sub>	to (64) <sub>H</sub>

## (h) Read Busy Flag &amp; Address

	RS	R/W	DB <sub>7</sub>	DB <sub>6</sub>	DB <sub>5</sub>	DB <sub>4</sub>	DB <sub>3</sub>	DB <sub>2</sub>	DB <sub>1</sub>	DB <sub>0</sub>	
Code	0	1	BF	A	A	A	A	A	A	A	
						←Higher order bit					Lower order bit→

This instruction reads out the internal status of the NJU6467. When this instruction is executed, the busy flag (BF) which indicate internal operation is read out from DB<sub>7</sub> and the address of the CG RAM, DD RAM and MK RAM is read out from DB<sub>6</sub> to DB<sub>0</sub> (the address for the CG RAM, DD RAM or MK RAM is determined by the previous instruction).

(BF)="1" indicates that internal operation is in progress. The next instruction is inhibited when (BF)="1". Check the (BF) status before the next write operation.

(i) Write Data to DD RAM, CG RAM or MK RAM

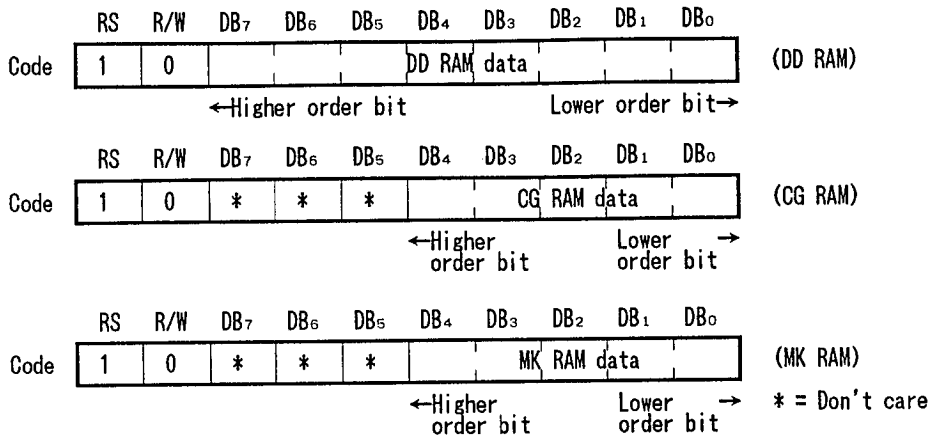

By the execution of this instruction, the RAM data of CG RAM, DD RAM or MK RAM is written into the CG RAM, DD RAM or MK RAM.

The selection of the RAM is determined by previous instruction (the RAM written must be selected before). After this instruction execution, the address increment (+1) or decrement (-1) is performed automatically according to the entry mode set. And the display shift is also executed according to the previous entry mode set.

(j) Read Data to DD RAM, CG RAM or MK RAM

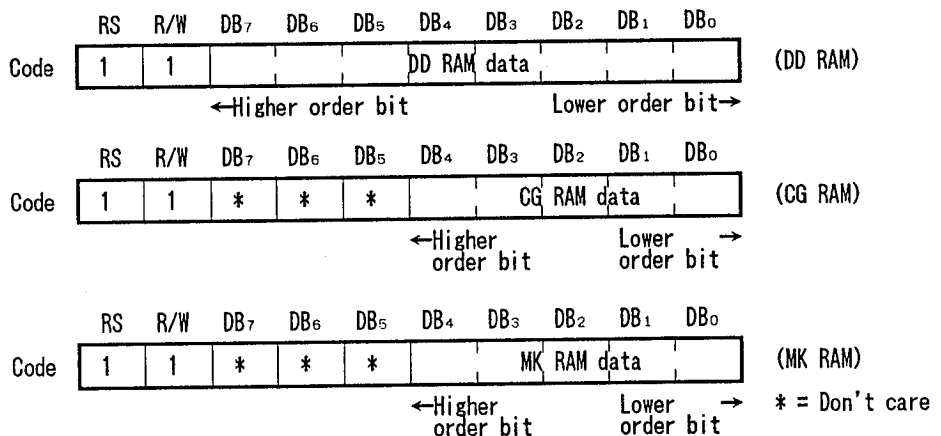

The CG RAM, DD RAM or MK RAM is determined by previous instruction.

Before executing this instruction, either the CG RAM address set, DD RAM address or MK RAM set must be executed, otherwise the first read out data are invalidated.

When this instruction is serially executed, the next address data is normally read from the second read.

The address set instruction is not required if the cursor shift instruction is executed just beforehand (only DD RAM reading). The cursor shift instruction has same function as the DD RAM address set.

After reading the RAM, the address increment or decrement is executed automatically according to the entry mode. But display shift does not occur regardless of the entry mode.



Note: The address counter(AC) is automatically incremented or decremented by 1 after write instruction to either of the DD RAM, CG RAM or MK RAM. Even if the read instruction is executed after this instruction, the addressed data can not be read out correctly. For a correct data read out, either the address set instruction or cursor shift instruction (only with DD RAM) must be implemented just before this instruction or from the second time read out instruction execution if the read out instruction is executed 2 times consecutively.

### (3-2) Initialization using the internal reset circuits

Display On/Off Control and Entry Set Instruction must be executed before the data input, as shown below.

The DD RAM of the NJU6467 can store up to 12 characters, as explained before, therefore the advertising moving display is available when combined with the display shift operation.

Since the display shift operation changes only display position and the DD RAM contents remain unchanged, display data which are entered first can be output when the return home operation is performed.

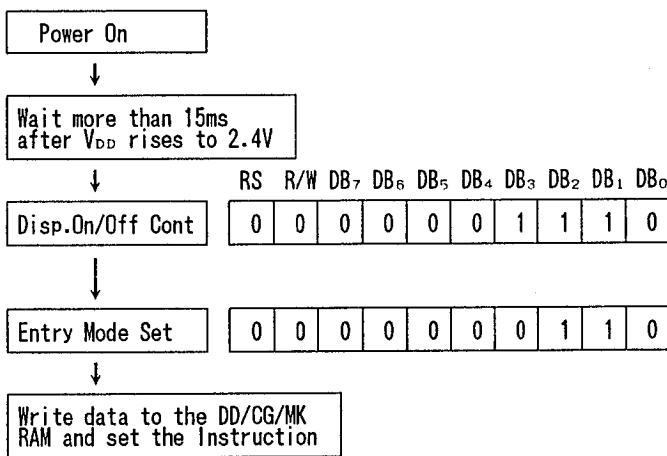

Initialized.  
No display appears.

Turns on display and cursor. Entire display is in space mode set by the initialization.

Example for set address increment and cursor right shift when the data write to the DD RAM, CG RAM or MK RAM.

### (3-3) Initialization by instruction

If the power supply conditions for the correct operation of the internal reset circuits are not met, the NJU6467 must be initialized by the following routine.

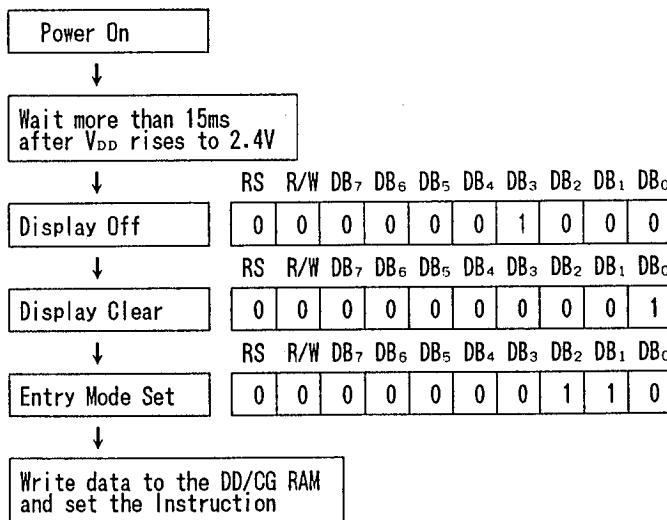

Initialized.  
No display appears.

Example for set address increment and cursor right shift when the data write to the DD RAM, CG RAM or MK RAM.

**(4) LCD DISPLAY**

**(4-1) Power Supply for LCD Driving**

In order to generate LCD driving waveform, the NJU6467 required external bleeder resistance. The bleeder resistance must be changed according to the duty ratio as shown below.

LCD Driving Voltage vs Duty Ratio

Power supply	Duty Ratio	1/16
	Bias	1/5
$V_1$		$V_{DD}$ to $1/5V_{LCD}$
$V_2$		$V_{DD}$ to $2/5V_{LCD}$
$V_3$		$V_{DD}$ to $3/5V_{LCD}$
$V_4$		$V_{DD}$ to $4/5V_{LCD}$
$V_5$		$V_{DD}$ to $V_{LCD}$

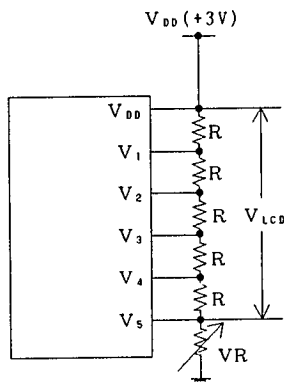

(a) 1/5 Bias (1/18 Duty)

**(4-2) Relation between oscillation frequency and LCD frame frequency.**

As the NJU6467 incorporate oscillation capacitor and resistance for CR oscillation, 45kHz oscillation is available without any external components.

The LCD frame frequency example mentioned below is based on 45kHz oscillation.

(1 clock = 22.2us)

1/18 duty

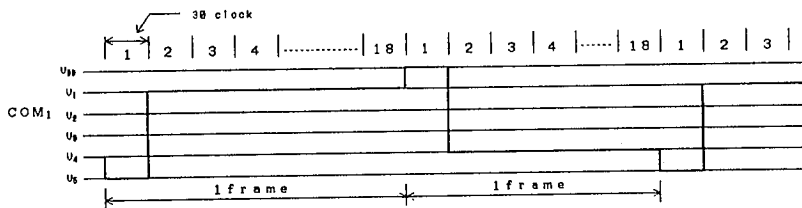

$$1 \text{ frame} = 22.2(\text{us}) \times 30 \times 18 = 12.0(\text{ms})$$

$$\text{Frame frequency} = 1/12.0(\text{ms}) = 83.3(\text{Hz})$$

**5**

(5) Serial Interface with MPU

Serial interface circuit is activated when the chip select terminal (CS) goes to "L" level. The data input/output is MSB first like as the order of DB<sub>7</sub>, DB<sub>6</sub> ... DB<sub>0</sub>.

The input data is entered into the shift register synchronized at the rise edge of the serial clock SCL. The shift register converted to parallel data at the CS rise edge input. In case of entering over than 8-bit data, valid data is last 8-bit data.

The output data is exited from the shift register synchronized at the fall edge of the serial clock SCL.

The time chart for the serial interface is shown below.

Note : The level ("L" or "H") of RS and R/W terminals should be set before CS terminal goes to "L" level.

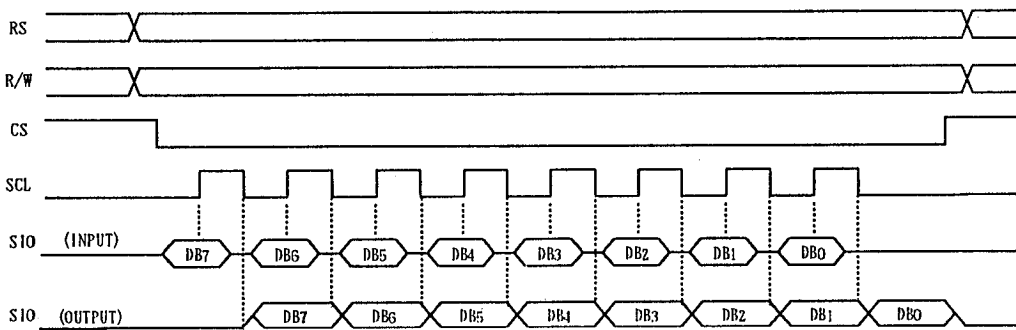

**■ ABSOLUTE MAXIMUM RATINGS**

 (  $T_a=25^{\circ}\text{C}$  )

PARAMETER	SYMBOL	RATINGS	UNIT
Supply Voltage (1)	$V_{DD}$	- 0.3 ~ + 7.0	V
Supply Voltage (2)	$V_S$	$V_{DD}-13.5 \sim V_{DD}+0.3$	V
Input Voltage	$V_{IN}$	- 0.3 ~ $V_{DD}+0.3$	V
Operating Temperature	$T_{opr}$	- 30 ~ + 80	$^{\circ}\text{C}$
Storage Temperature	$T_{stg}$	- 55 ~ + 125	$^{\circ}\text{C}$

Note 1) If the LSI are used on condition above the absolute maximum ratings, the LSI may be destroyed. Using the LSI within electrical characteristics is strongly recommended for normal operation. Use beyond the electric characteristics conditions will cause malfunction and poor reliability.

Note 2) Decoupling capacitor should be connected between  $V_{DD}$  and  $V_{SS}$ ,  $V_{DD}$  and  $V_S$  due to the stabilized operation for the LSI.

Note 3) All voltage values are specified as  $V_{SS} = 0\text{V}$

Note 4) The relation :  $V_{DD} \geq V_{SS}$ ,  $V_{DD} \geq V_1 \geq V_2 \geq V_3 \geq V_4 \geq V_5$ ,  $V_{SS}=0\text{V}$  must be maintained.

Turn on  $V_{DD}$  and  $V_S$  at same time or turn on  $V_{DD}$  first then turn on  $V_S$  must be required. If the turn on sequence does not meet above conditions, latch up will occur.

**■ ELECTRICAL CHARACTERISTICS**

 (  $V_{DD}=3\text{V} \pm 20\%$ ,  $V_{SS}=0\text{V}$ ,  $T_a=-20 \sim +75^{\circ}\text{C}$  )

PARAMETER	SYMBOL	CONDITIONS	MIN	TYP	MAX	UNIT	NOTE
Operating Voltage (1)	$V_{DD}$		2.4		3.6	V	
Operating Voltage (2)	$V_S$		$V_{DD}-$ 3.0		$V_{DD}-$ 13.5	V	
Input Voltage	$V_{IH}$		0.8 $V_{DD}$		$V_{DD}$	V	5
	$V_{IL}$			0.2 $V_{DD}$			
Output Voltage	$V_{OH}$	$-I_{OH}=0.205\text{mA}$	2.0			V	6
	$V_{OL}$	$I_{OL}=1.6\text{mA}$			0.5		
Driver On-resist.(COM)	$R_{COM}$	$\pm I_d=10\mu\text{A}$ (All com.term.)			20	k $\Omega$	9
Driver On-resist.(SEG)	$R_{SEG}$	$\pm I_d=10\mu\text{A}$ (All seg.term.)			30		
Input Leakage Current	$I_{LI}$	$V_{IN}=0 \sim V_{DD}$	- 1		1	$\mu\text{A}$	7
Pull-up Resistance Current	$-I_P$	$V_{DD}=3\text{V}$	10	25	50	$\mu\text{A}$	
Operating Current	$I_{DD}$	$V_{DD}=3\text{V}$ , $f_{OSC}$ =Internal freq			50	$\mu\text{A}$	8
Oscillation Frequency	$f_{OSC}$	$V_{DD}=3\text{V}$ , $T_a=25^{\circ}\text{C}$	25	45	70	kHz	
Output Current	$I_S$	$V_{DD}=V_{ci}=3\text{V}$			50	$\mu\text{A}$	

Note 5) Input/Output structure except LCD driver are shown below:

Input Terminal Structure

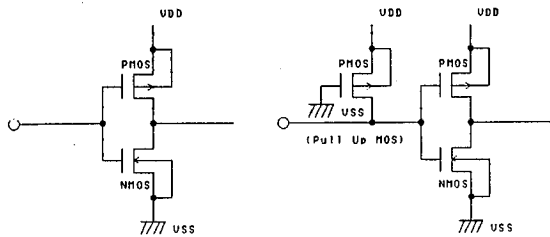

CS, SCL Terminals  
(No Pull-Up MOS)

RS, R/W, RESET Terminals  
(Pull-Up MOS)

Input/Output Terminal Structure

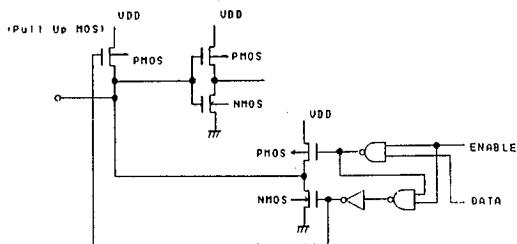

SIO Terminal

Note 6) Apply to the Output and Input/Output Terminal.

Note 7) Except pull-up MOS current and output driver current.

Note 8) Except Input/output current.

If the input level is medium, current consumption will increase due to the penetration current. Therefore, the input level must be fixed to "H" or "L".

Note 9) The relation :  $V_5 = -10.5V$ ,  $V_4 = -7.8V$ ,  $V_3 = -5.1V$ ,  $V_2 = -2.4V$ ,  $V_1 = 0.3V$ ,  $V_{DD} = 3.0$

## • Serial Interface Sequence

 (  $V_{DD}=3V\pm 20\%$ ,  $V_{SS}=0V$ ,  $T_a=-20\sim+75^\circ C$  )

PARAMETER		SYMBOL	MIN	MAX	CONDITION	UNIT
Serial Clock Cycle Time		$t_{CYCE}$	1.3		fig. 1	$\mu s$
Serial Clock Width	"High" level	$t_{SCH}$	0.3			$\mu s$
	"LOW" level	$t_{SCL}$	1.0			$\mu s$
Serial Clock rise and fall Time		$t_{SCR}, t_{SCF}$		20		ns
Chip Select Pulse Width		$PW_{CS}$	500			ns
Chip Select Setup Time		$t_{CSU}$	40			ns
Chip Select Hold Time		$t_{CH}$	60			ns
Chip Select rise and fall Time		$t_{CSR}, t_{CSF}$		20		ns
Setup Time	RS, R/W - CS	$t_{AS}$	60			ns
Address Hold Time		$t_{AH}$	20			ns
Serial Input Data Setup Time		$t_{SISU}$	60			ns
Serial Input Data Hold Time		$t_{SIH}$	40			ns
Serial Output Data Delay Time		$t_{SOD}$		950		ns
Serial Output Date Hold Time		$t_{SOH}$	0			ns

 -SIO Load Condition :  $CL=100pF$ 

## Serial Interface Timing Characteristics

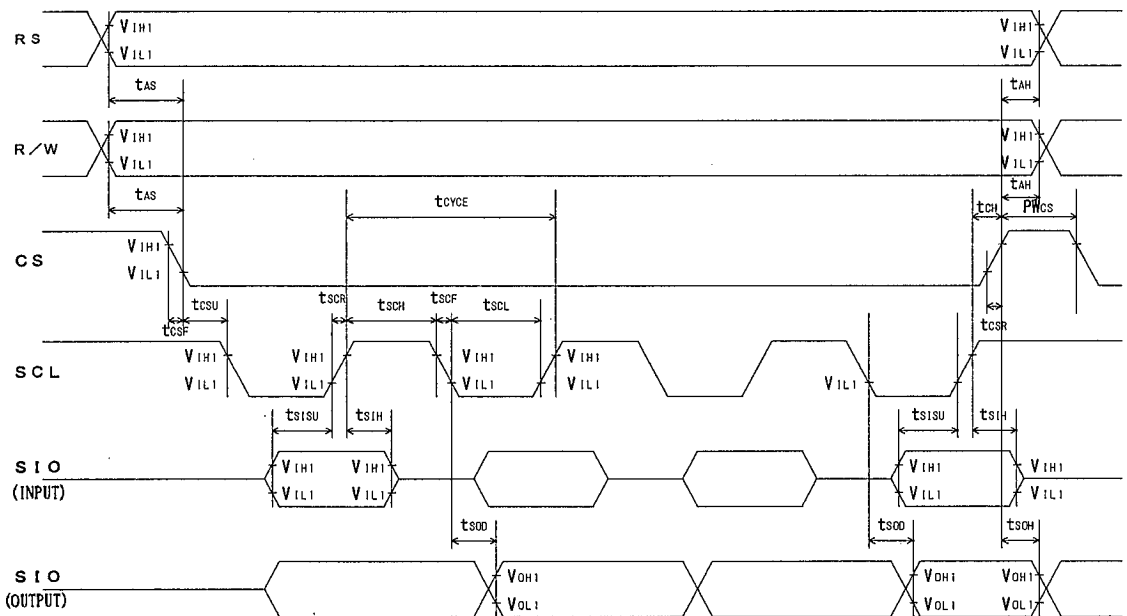
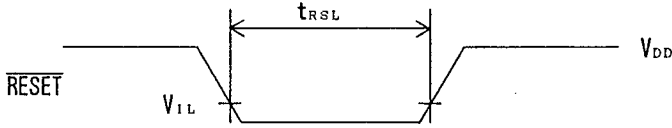

fig.1 The timing characteristics of the serial bus write/read operating sequence.

• The Input Condition when using the Hardware Reset Circuit

Input Timing



PARAMETER	SYMBOL	CONDITION	MIN	MAX	UNIT
Reset Input "L" Level Width	$t_{RSL}$	$f_{OSC}=45\text{kHz}$	1.2	-	ms

• Power Supply Condition when using the internal initialization circuit( $T_a=-20\sim+75^\circ\text{C}$ )

PARAMETER	SYMBOL	CONDITION	MIN	MAX	UNIT
Power Supply Rise Time	$t_{rDD}$		0.1	5	ms
Power Supply OFF Time	$t_{OFF}$		1		

Since the internal initialization circuits will not operate normally unless the above conditions are met, in such a case initialize by instruction.  
(Refer to initialization by the instruction)

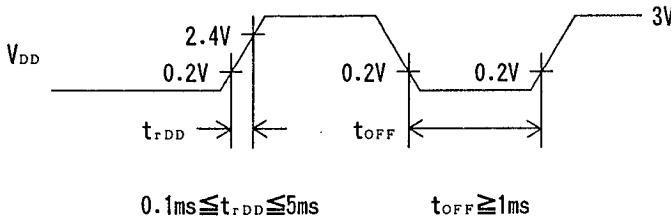

$t_{OFF}$  specifies the power off time in a short period off or cyclical on/off.

■ LCD DRIVING WAVE FORM

1/18 Duty Driving

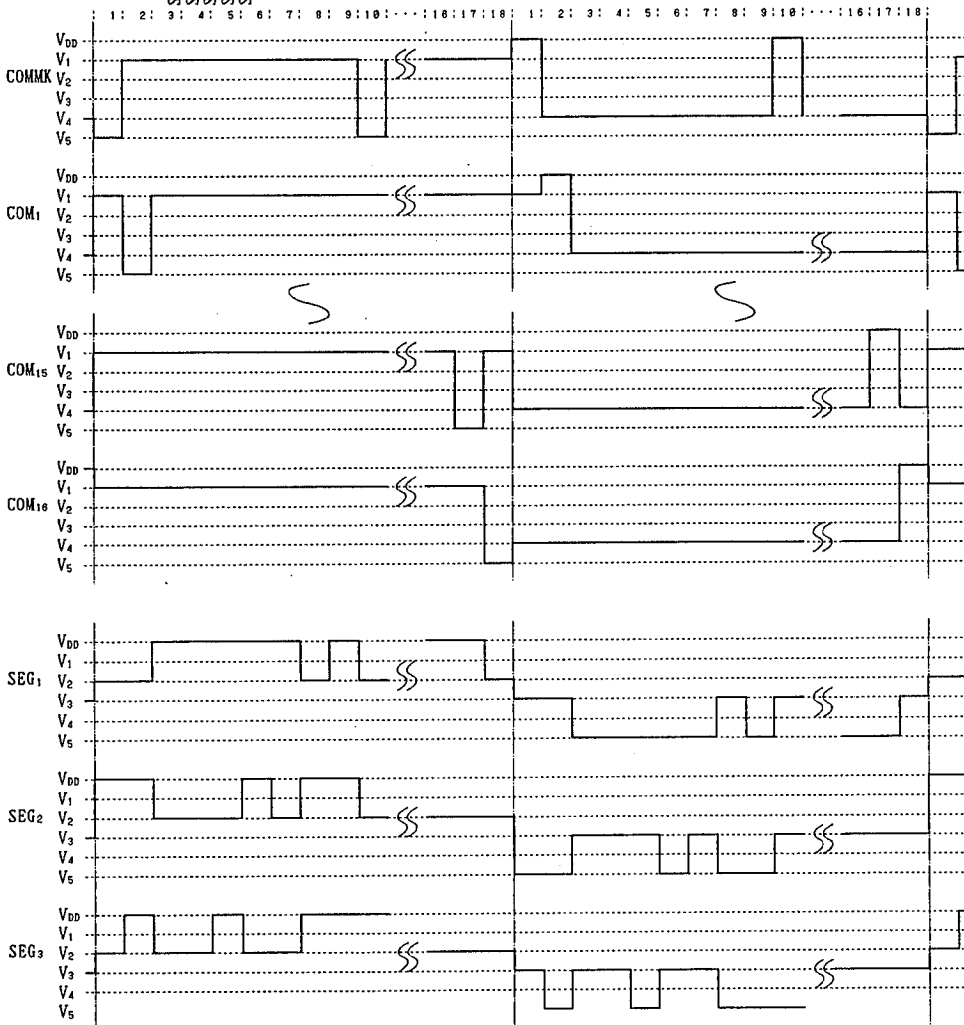
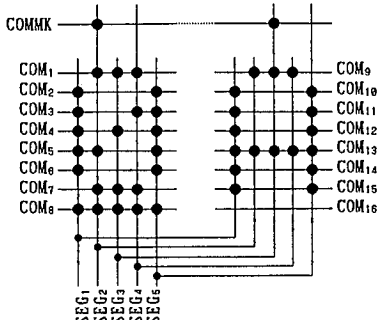

5



■ APPLICATION CIRCUITS

12-Character 1-Line With Icon Display Example

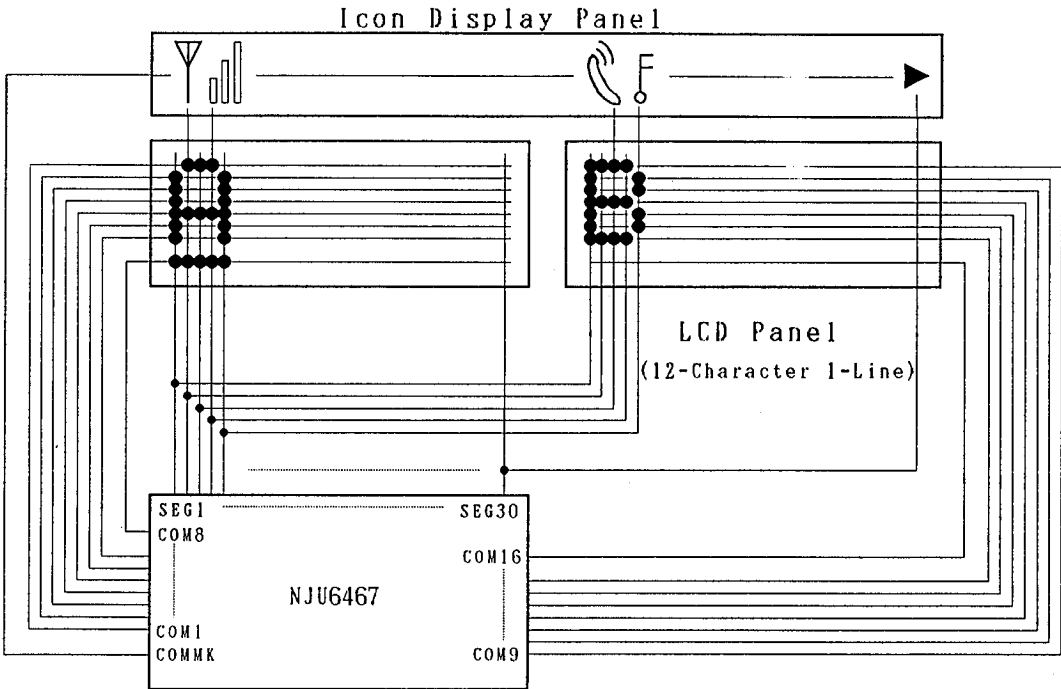

## MEMO

**[CAUTION]**

The specifications on this databook are only given for information, without any guarantee as regards either mistakes or omissions. The application circuits in this databook are described only to show representative usages of the product and not intended for the guarantee or permission of any right including the industrial rights.