

4-BIT SINGLE CHIP OTP MICRO CONTROLLER

■ GENERAL DESCRIPTION

The **NJU3554** is the C-MOS 4-bit Single Chip OTP type Micro Controller with programmable Flash Memory.

It is completely compatible with the **NJU3504** in function and the pin configuration. Therefore, the **NJU3554** is suitable for the final evaluation before **NJU3504** mask generation, the small quantity production and short lead-time.

* In this data sheet, only OTP programming and the difference between **NJU3554** and **NJU3504** are mentioned mainly. Therefore the detail function and specification should be referred on the **NJU3504** data sheet.

■ PACKAGE OUTLINE

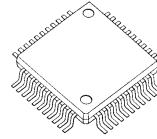

NJU3554FA1

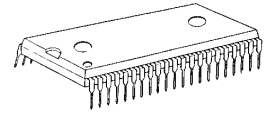

NJU3554L

■ FEATURES

- Internal One Time Programmable ROM 4,096 X 8bits
- Internal Data RAM 256 X 4bits
- Wide operating voltage range 2.7V ~ 5.5V
- Package outline QFP44-A1 / SDIP42 (Compatible with **NJU3504**)
- ROM programmer "SUPERPRO/L" by XELTEK co.,.

■ PIN CONFIGURATION IN OTP PROGRAMMING MODE

[QFP44-A1]

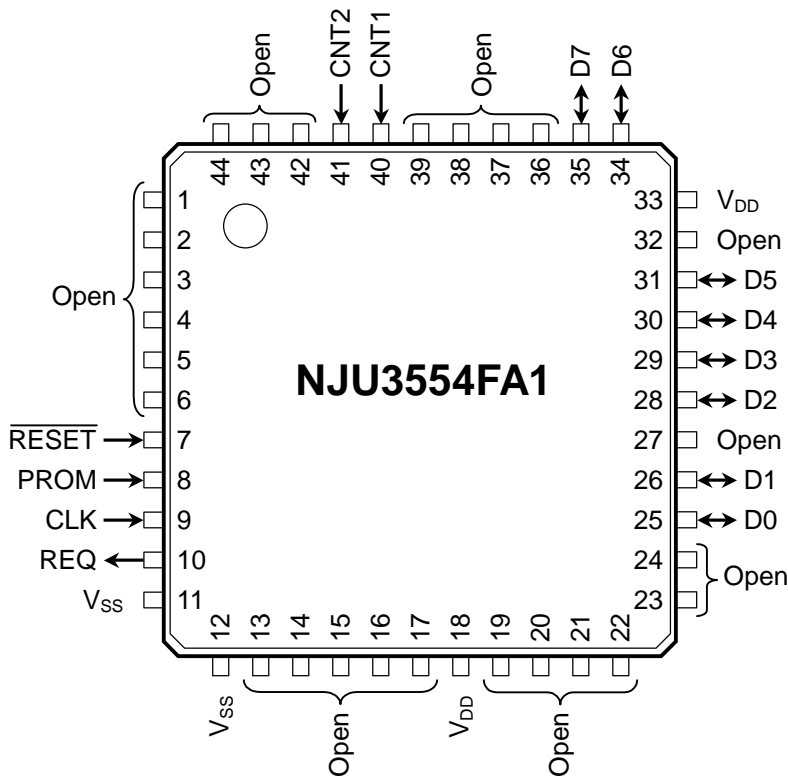

[SDIP42]

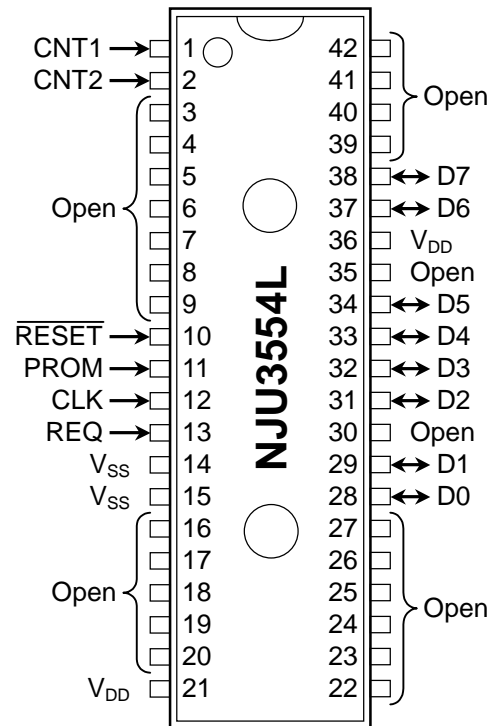

Note) The pin configuration in Normal operating mode is the same as **NJU3504**.

■ BLOCK DIAGRAM

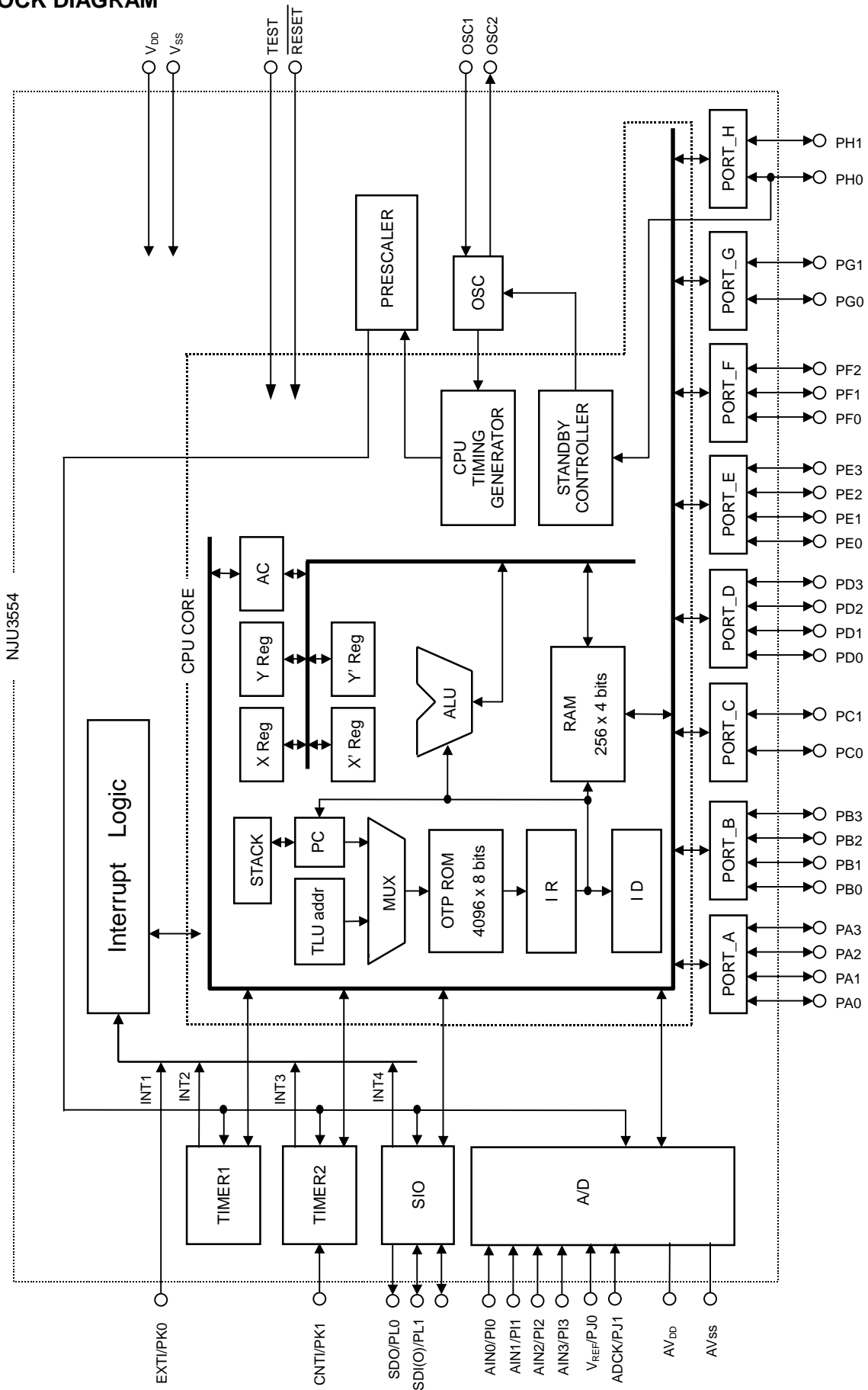

* Refer [INPUT OUTPUT TERMINAL TYPE]

■ TERMINAL DESCRIPTION IN OTP PROGRAMMING MODE

No.		SYMBOL	INPUT / OUTPUT	FUNCTION
NJU 3554F	NJU 3554L			
7	10	$\overline{\text{RESET}}$	INPUT	RESET terminal. When the low-level input-signal, the system is initialized.
25, 26, 28-31, 34, 35	28, 29, 31-34, 37, 38	D0 - D7	INPUT/OUTPUT	Data bus
1	40,	CNT1	INPUT	OTP control input terminal
2	41	CNT2	INPUT	
10	13	REQ	OUTPUT	Request output terminal
9	12	CLK	INPUT	Clock input terminal
8	11	PROM	INPUT	OTP programming enable terminal
18, 33	21, 36	V _{DD}	-	Power Source (5V)
11, 12	14, 15	V _{SS}	-	Power Source (0V)

- Note 1) Use at V_{DD}=5V in OTP programming mode.
 2) Non connect anything to the other terminals.

■ Difference between NJU3554 (OTP version) and NJU3504 (MASK version)

● Operating mode

NJU3554 has two operating modes. One is "Normal operating mode" and the other is "OTP programming mode".

• Normal operating mode

The "TEST" terminal is set to low level. (The terminal is recommended to connect to GND.)
 Operating voltage range; 2.7V ~ 5.5V.

• OTP Programming mode

User program is read out from or written into the OTP by the universal programmer "SUPERPRO/L" and converting adapter made by XELTEK co.,(USA).

● Reset Terminal Type

	NJU3554	NJU3504
Internal Pull-up Resistance	With Pull-up	Without Pull-up

● Option information set in the initialization

When the initialization is performed($\overline{\text{RESET}}$ terminal is "L"), the operation information stored in option area is set as shown in the following timing chart. The option information is set in the term of $1 / f_{\text{osc}} \times 512\text{clock}$ after RESET releasing and oscillation stability time. After information set, the program counter is set to 0000H and the **NJU3554** operates in normal.

[TIMING CHART]

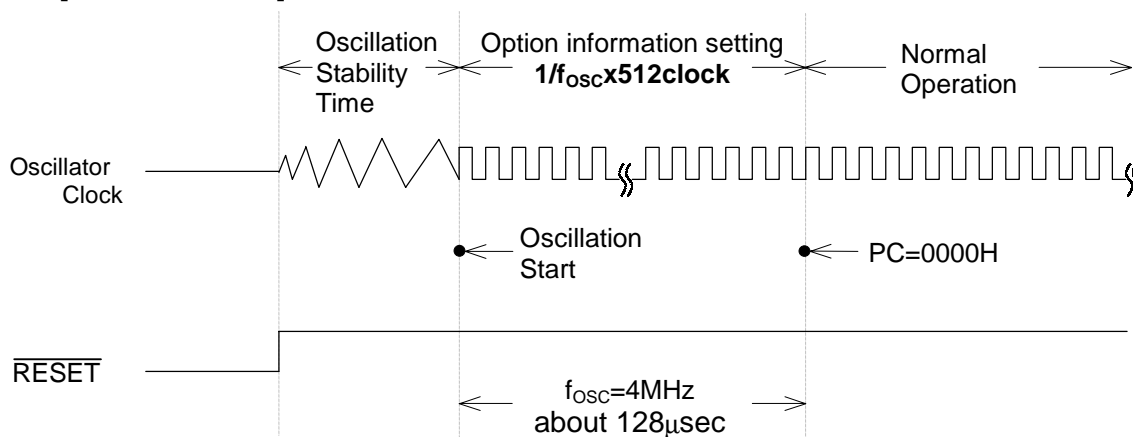

NJU3554

■ ABSOLUTE MAXIMUM RATINGS

(Ta=25°C)

PARAMETER	SYMBOL	RATINGS	UNIT
Supply Voltage	V _{DD}	-0.3 ~ +7.0	V
Input Voltage	V _{IN}	-0.3 ~ V _{DD} + 0.3	V
Output Voltage	V _{OUT}	-0.3 ~ V _{DD} + 0.3	V
Analog Supply Voltage	AV _{DD}	-0.3 ~ V _{DD} + 0.3	V
Analog Reference Voltage	V _{REF}	-0.3 ~ AV _{DD} + 0.3	V
Analog Input Voltage	AIN0 ~ AIN3	-0.3 ~ AV _{DD} + 0.3	V
Operating Temperature	T _{opr}	-20 ~ +75	°C
Storage Temperature	T _{stg}	-55 ~ +125	°C

Note)

The difference of electrical characteristics between **NJU3554** (OTP version) and **NJU3504** (MASK version)

	NJU3504		NJU3554
•Supply Voltage (V _{DD}) MIN.	2.4V	→	2.7V
•Supply Current			
5V (I _{DD1}) Max.	4.0mA	→	30mA
(I _{DD2}) Max.	4.0mA	→	30mA
(I _{DD3}) Max.	3.8mA	→	30mA
(I _{DD4}) Max.	5.2mA	→	30mA
(I _{DD5}) Max.	4.0μA	→	20μA
3V (I _{DD1}) Max.	2.0mA	→	20mA
(I _{DD2}) Max.	2.0mA	→	20mA
(I _{DD3}) Max.	1.8mA	→	20mA
(I _{DD4}) Max.	1.4mA	→	20mA
(I _{DD5}) Max.	2.0μA	→	20μA

■ ELECTRICAL CHARACTERISTICS DC CHARACTERISTICS 1-1

($V_{DD}=3.6\sim 5.5V$, $V_{SS}=0V$, $T_a=-20\sim 75^{\circ}C$)

PARAMETER	SYM BOL	CONDITIONS	MIN	TYP	MAX	UNIT	NOTE
Supply Voltage	V_{DD}	V_{DD}	3.6		5.5	V	
Supply Current	I_{DD1}	V_{DD} $V_{DD}=5V$, $f_{OSC}=2MHz$ X'tal Oscillation in Reset			30	mA	*3
	I_{DD2}	V_{DD} $V_{DD}=5V$, $f_{OSC}=2MHz$ Ceramic Oscillation in Reset			30	mA	*3
	I_{DD3}	V_{DD} $V_{DD}=5V$, $f_{OSC}=2MHz$ CR Oscillation in Reset			30	mA	*3
	I_{DD4}	V_{DD} $V_{DD}=5V$, $f_{OSC}=4MHz$ Operating (Except ADC)			30	mA	*3
	I_{DD5}	V_{DD} $V_{DD}=5V$, STANDBY Mode			20	μA	*3
	I_{ADD}	AV_{DD} $AV_{DD}=V_{DD}=5V$, $ADCK=225kHz$			3.0	5.0	mA
High-Level Input Voltage	V_{IH1}	PA0~PA3, PB0~PB3, PC0, PC1, PD0~PD3, PE0~PE3, AIN0/PI0~AIN3/PI3, SDI(O)/PL1, SCK/CKOUT	$0.7V_{DD}$		V_{DD}	V	*1
	V_{IH2}	PF0~PF2, PG0, PG1, PH0, PH1, $V_{REF}/PJ0$, $ADCK/PJ1$, $EXTI/PK0$, CNTI/PK1, \overline{RESET}	$0.8V_{DD}$		V_{DD}	V	*1
	V_{IH3}	OSC1	$V_{DD}-1.0$		V_{DD}	V	
Low-level Input Voltage	V_{IL1}	PA0~PA3, PB0~PB3, PC0, PC1, PD0~PD3, PE0~PE3, AIN0/PI0~AIN3/PI3, SDI(O)/PL1, SCK/CKOUT	0		$0.3V_{DD}$	V	*1
	V_{IL2}	PF0~PF2, PG0, PG1, PH0, PH1, $V_{REF}/PJ0$, $ADCK/PJ1$, $EXTI/PK0$, CNTI/PK1, \overline{RESET}	0		$0.2V_{DD}$	V	*1
	V_{IL3}	OSC1	0		1.0	V	

*1 Input/output port is set as an Input terminal.

*2 Input/output port is set as an Output terminal.

*3 Except the current through Pull-up resistor.

■ ELECTRICAL CHARACTERISTICS DC CHARACTERISTICS 1-2

($V_{DD}=3.6\sim 5.5V$, $V_{SS}=0V$, $T_a=-20\sim 75^{\circ}C$)

PARAMETER	SYM BOL	CONDITIONS	MIN	TYP	MAX	UNIT	NOTE
High-Level Input Current	I_{IH}	$V_{DD}=5.5V$, $V_{IN}=5.5V$ PA0~PA3, PB0~PB3, PC0, PC1, PD0~PD3, PE0~PE3, PF0~PF2, PG0, PG1, PH0, PH1, AIN0/PI0~AIN3/PI3, $V_{REF}/PJ0$, ADCK/PJ1, EXTI/PK0, CNTI/PK1, SDI(O)/PL1, RESET, SCK/CKOUT			10	μA	*1
Low-Level Input Current	I_{IL1}	$V_{DD}=5.5V$, $V_{IN}=0V$ Without pull-up resistance PA0~PA3, PB0~PB3, PC0, PC1, PD0~PD3, PE0~PE3, PF0~PF2, PG0, PG1, PH0, PH1, AIN0/PI0~AIN3/PI3, $V_{REF}/PJ0$, ADCK/PJ1, EXTI/PK0, CNTI/PK1, SDI(O)/PL1, SCK/CKOUT			-10	μA	*1
	I_{IL2}	$V_{DD}=5.5V$, $V_{IN}=0V$ With pull-up resistance PA0~PA3, PB0~PB3, PC0, PC1, PD0~PD3, PE0~PE3, PF0~PF2, PG0, PG1, PH0, PH1, AIN0/PI0~AIN3/PI3, $V_{REF}/PJ0$, ADCK/PJ1, EXTI/PK0, CNTI/PK1, SDI(O)/PL1, RESET, SCK/CKOUT			-100	μA	*1
High-Level Output Voltage	V_{OH}	$I_{OH}=-100\mu A$ PD0~PD3, PE0~PE3, PF0~PF2, PG0, PG1, PH0, PH1, SDO/PL0, SDI(O)/PL1, SCK/CKOUT	$V_{DD}-0.5$			V	*2
Low-Level Output Voltage	V_{OL1}	$I_{OL1}=400\mu A$ PD0~PD3, PE0~PE3, PF0~PF2, PG0, PG1, PH0, PH1, SDO/PL0, SDI(O)/PL1, SCK/CKOUT			0.5	V	*2
	V_{OL2}	$I_{OL2}=15mA$ PA0~PA3, PB0~PB3, PC0, PC1			2.0	V	*2
Output Leakage Current	I_{OD}	$V_{DD}=5.5V$, $V_{OH}=5.5V$ PA0~PA3, PB0~PB3, PC0, PC1			10	μA	*2
Input Capacitance	C_{IN}	Except V_{DD} , V_{SS} terminals $f_{OSC}=1MHz$ Other terminals : 0V		10	20	pF	

*1 Input/output port is set as an Input terminal.

*2 Input/output port is set as an Output terminal.

*3 Except the current through Pull-up resistor.

■ ELECTRICAL CHARACTERISTICS DC CHARACTERISTICS 2-1

($V_{DD}=2.7\sim 3.6V$, $V_{SS}=0V$, $T_a=-20\sim 75^\circ C$)

PARAMETER	SYM BOL	CONDIT IONS	MIN	TYP	MAX	UNIT	NOTE
Supply Voltage	V_{DD}	V_{DD}	2.7		3.6	V	
Supply Current	I_{DD1}	V_{DD} $V_{DD}=3V$, $f_{OSC}=1MHz$ X'tal Oscillation in Reset			20	mA	*3
	I_{DD2}	V_{DD} $V_{DD}=3V$, $f_{OSC}=1MHz$ Ceramic Oscillation in Reset			20	mA	*3
	I_{DD3}	V_{DD} $V_{DD}=3V$, $f_{OSC}=1MHz$ CR Oscillation in Reset			20	mA	*3
	I_{DD4}	V_{DD} $V_{DD}=3V$, $f_{OSC}=2MHz$ Operating (Except ADC)			20	mA	*3
	I_{DD5}	V_{DD} $V_{DD}=3V$, STANDBY Mode			20	μA	*3
	I_{ADD}	AV_{DD} $AV_{DD}=V_{DD}=3V$, $ADCK=225kHz$		2.5	3.5	mA	*3
High-Level Input Current	V_{IH1}	PA0~PA3, PB0~PB3, PC0, PC1, PD0~PD3, PE0~PE3, AIN0/PI0~AIN3/PI3, SDI(O)/PL1, SCK/CKOUT	$0.8V_{DD}$		V_{DD}	V	*1
	V_{IH2}	PF0~PF2, PG0, PG1, PH0, PH1, $V_{REF}/PJ0$, $ADCK/PJ1$, $EXTI/PK0$, CNTI/PK1, \overline{RESET}	$0.85V_{DD}$		V_{DD}	V	*1
	V_{IH3}	OSC1	$V_{DD}-0.3$		V_{DD}	V	
Low-Level Input Voltage	V_{IL1}	PA0~PA3, PB0~PB3, PC0, PC1, PD0~PD3, PE0~PE3, AIN0/PI0~AIN3/PI3, SDI(O)/PL1, SCK/CKOUT	0		$0.2V_{DD}$	V	*1
	V_{IL2}	PF0~PF2, PG0, PG1, PH0, PH1, $V_{REF}/PJ0$, $ADCK/PJ1$, $EXTI/PK0$, CNTI/PK1, \overline{RESET}	0		$0.15V_{DD}$	V	*1
	V_{IL3}	OSC1	0		0.3	V	

*1 Input/output port is set as an Input terminal.

*2 Input/output port is set as an Output terminal.

*3 Except the current through Pull-up resistor.

■ ELECTRICAL CHARACTERISTICS DC CHARACTERISTICS 2-2

($V_{DD}=2.7\sim 3.6V$, $V_{SS}=0V$, $T_a=-20\sim 75^\circ C$)

PARAMETER	SYMBOL	CONDITIONS	MIN	TYP	MAX	UNIT	NOTE
High-Level Input Current	I_{IH}	$V_{DD}=3.6V$, $V_{IN}=3.6V$ PA0~PA3, PB0~PB3, PC0, PC1, PD0~PD3, PE0~PE3, PF0~PF2, PG0, PG1, PH0, PH1, AIN0/PI0~AIN3/PI3, $V_{REF}/PJ0$, ADCK/PJ1, EXTI/PK0, CNTI/PK1, SDI(O)/PL1, RESET, SCK/CKOUT			10	μA	*1
Low-Level Input Current	I_{IL1}	$V_{DD}=3.6V$, $V_{IN}=0V$ Without pull-up resistance PA0~PA3, PB0~PB3, PC0, PC1, PD0~PD3, PE0~PE3, PF0~PF2, PG0, PG1, PH0, PH1, AIN0/PI0~AIN3/PI3, $V_{REF}/PJ0$, ADCK/PJ1, EXTI/PK0, CNTI/PK1, SDI(O)/PL1, SCK/CKOUT			-10	μA	*1
	I_{IL2}	$V_{DD}=3.6V$, $V_{IN}=0V$ With pull-up resistance PA0~PA3, PB0~PB3, PC0, PC1, PD0~PD3, PE0~PE3, PF0~PF2, PG0, PG1, PH0, PH1, AIN0/PI0~AIN3/PI3, $V_{REF}/PJ0$, ADCK/PJ1, EXTI/PK0, CNTI/PK1, SDI(O)/PL1, RESET, SCK/CKOUT			-100	μA	*1
High-Level Output Voltage	V_{OH}	$I_{OH}=-80\mu A$ PD0~PD3, PE0~PE3, PF0~PF2, PG0, PG1, PH0, PH1, SDO/PL0, SDI(O)/PL1, SCK/CKOUT	$V_{DD}-0.5$			V	*2
Low-Level Output Voltage	V_{OL1}	$I_{OL1}=350\mu A$ PD0~PD3, PE0~PE3, PF0~PF2, PG0, PG1, PH0, PH1, SDO/PL0, SDI(O)/PL1, SCK/CKOUT			0.5	V	*2
	V_{OL2}	$I_{OL2}=5mA$ PA0~PA3, PB0~PB3, PC0, PC1			1.0	V	*2
Output Leakage Current	I_{OD}	$V_{DD}=3.6V$, $V_{OH}=3.6V$ PA0~PA3, PB0~PB3, PC0, PC1			10	μA	*2
Input Capacitance	C_{IN}	Except V_{DD} , V_{SS} terminals $f_{OSC}=1MHz$ Other terminals : 0V		10	20	pF	

*1 Input/output port is set as an Input terminal.

*2 Input/output port is set as an Output terminal.

*3 Except the current through Pull-up resistor.

■ ELECTRICAL CHARACTERISTICS AC CHARACTERISTICS 1

(V_{SS}=0V, T_a= -20~75°C)

PARAMETER	SYM BOL	CONDITIONS		MIN	TYP	MAX	UNIT
Operating Frequency	f _{OSC}	V _{DD} =2.7~3.6V	X'tal Resonator	0.03		2.0	MHz
			Ceramic Resonator	0.03		2.0	
			External Resistor Oscillation	0.03		1.0	
				External Clock	0.03		
		V _{DD} =3.6~5.5V	X'tal Resonator	0.03		4.0	
			Ceramic Resonator	0.03		4.0	
			External Resistor Oscillation	0.03		2.0	
				External Clock	0.03		
Instruction Cycle Time	t _C			6/f _{OSC}		s	
External Clock Pulse Width	t _{CPH}	V _{DD} =2.7~3.6V	250		16600	ns	
	t _{CPL}	V _{DD} =3.6~5.5V	125		16600		
External Clock Rise Time Fall Time	t _{CPR}	V _{DD} =2.7~5.5V			20	ns	
	t _{CPF}						
RESET Low-Level Width	t _{RST}	V _{DD} =2.7~5.5V	4/f _{OSC}			s	
RESET Rise Time	t _{RSR}	V _{DD} =2.7~5.5V			20	ms	
Port Input Level Width	t _{PIN}	V _{DD} =2.7~5.5V	6/f _{OSC}			s	
Edge Detection (PH1) Rise Time Fall Time	t _{EDR}	V _{DD} =2.7~5.5V			200	ns	
	t _{EDF}						
Restart Signal (PH0) Rise Time	t _{STR}	V _{DD} =2.7~5.5V			200	ns	
External interrupt input (EXTI) Rise Time	t _{EXR}	V _{DD} =2.7~5.5V			200	ns	
CNTI Clock Frequency	f _{CT}	V _{DD} =2.7~5.5V			f _{OSC} /64	Hz	
CNTI High-Level Width	t _{CT}	V _{DD} =2.7~5.5V	6/f _{OSC}			s	
CNTI Rise Time Fall Time	t _{CTR}	V _{DD} =2.7~5.5V			200	ns	
	t _{CTF}						

■ AC CHARACTERISTICS 1 TIMING CHART

EXTERNAL CLOCK

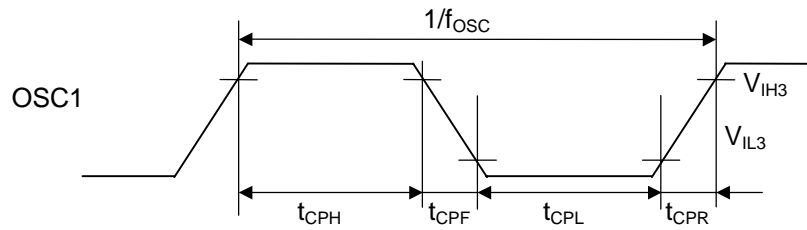

RESET INPUT

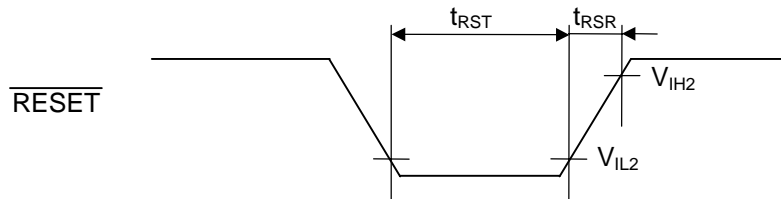

PORT INPUT

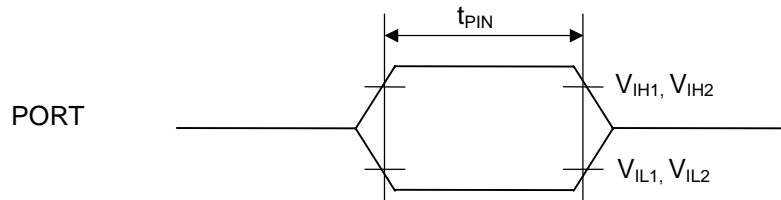

EDGE DETECTOR INPUT

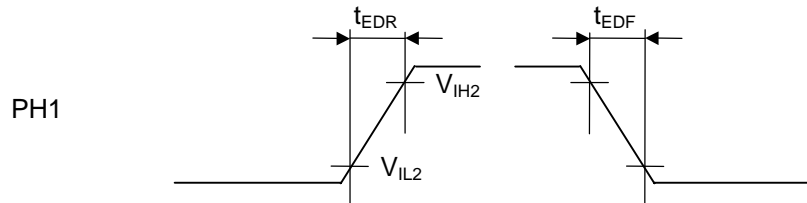

RESTART SIGNAL INPUT

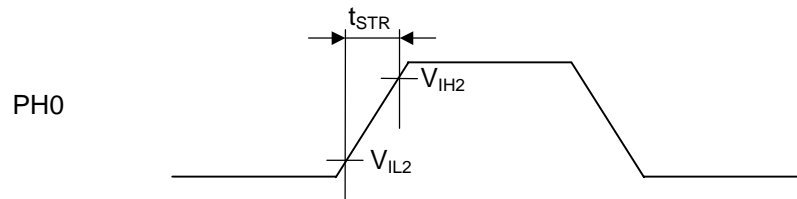

EXTERNAL INTERRUPT

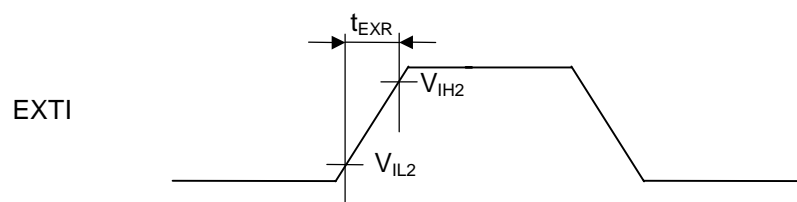

TIMER2 EXTERNAL CLOCK TIMING CHART

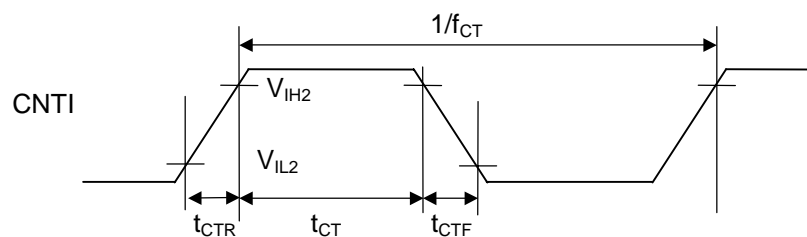

■ ELECTRICAL CHARACTERISTICS AC CHARACTERISTICS 2 SERIAL INTERFACE

($V_{SS}=0V$, $V_{DD}=2.7\sim 5.5V$, $T_a=-20\sim 75^\circ C$)

PARAMETER	SYM BOL	CONDITIONS		MIN	TYP	MAX	UNIT
Serial Operating Frequency	f_{SC}	Internal Clock				$(1/12) \times f_{OSC}^*$	Hz
		External Clock				500k	
Clock Pulse Width Low-Level	t_{SCL}	Internal Clock	$V_{DD}=2.7\sim 3.6V$ $f_{OSC}=2MHz$	3.0			μs
			$V_{DD}=3.6\sim 5.5V$ $f_{OSC}=4MHz$	1.5			
		External Clock		1.0			
Clock Pulse Width High-Level	t_{SCH}	Internal Clock	$V_{DD}=2.7\sim 3.6V$ $f_{OSC}=2MHz$	3.0			μs
			$V_{DD}=3.6\sim 5.5V$ $f_{OSC}=4MHz$	1.5			
		External Clock		1.0			
SDI setup Time To SCK	t_{DS}			0.5			μs
SDI Hold time To SCK	t_{DH}			0.5			μs
SDO Data Fix Time To SCK	t_{DCD}					0.5	μs

* The dividing ratio of the internal clock is 1/2.

■ AC CHARACTERISTICS 2 SERIAL INTERFACE TIMING CHART

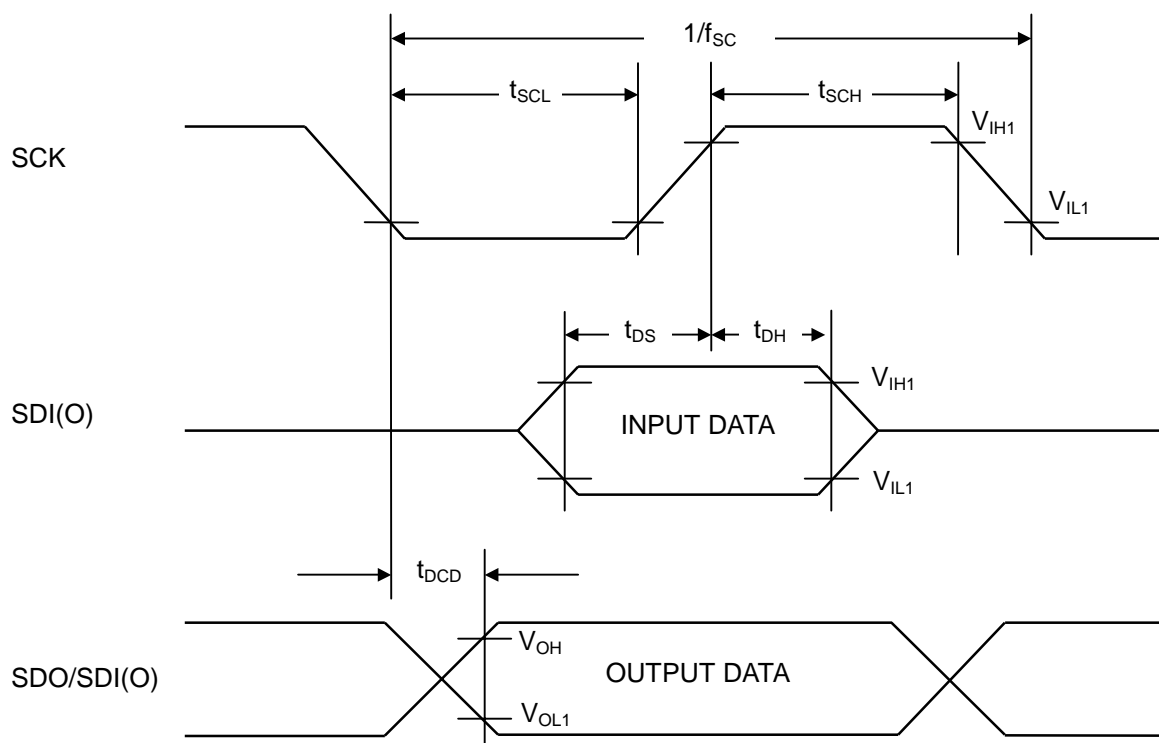

■ ELECTRICAL CHARACTERISTICS A/D CONVERTER CHARACTERISTICS

($V_{DD}=AV_{DD}=2.7\sim 5.5V$, $V_{SS}=AV_{SS}=0V$, $T_a=25^\circ C$, $f_{OSC}=4MHz$)

PARAMETER	SYMBOL	CONDITIONS	MIN	TYP	MAX	UNIT
Resolution	-		-	8	-	bits
Absolute Accuracy	-	$V_{DD}=5V$, $AV_{DD}=5V$, $V_{REF}=5V$			± 2	LSB
Conversion Time	t_{CONV}	$V_{DD}=5V$, $AV_{DD}=5V$, $V_{REF}=5V$	40			μs
Reference Voltage	V_{REF}		2.7		AV_{DD}	V
Analog Input Voltage	V_{IA}		AV_{SS}		V_{REF}	V
ADCK Frequency	f_{ADCK}				225	kHz

■ **OPTION as same as mask version (NJU3504)**

1) INPUT OUTPUT Terminal Selection

All of input-output terminals select a terminal type for each port from the following table1 and table2 by the mask option.

[CIRCUIT TYPE TABLE 1]

SYMBOL	TERMINAL TYPES			EXTRA FUNCTION	REMARKS
	Input / Output Terminal*1				
	Port of Input	Port of Output	Programmable Input / Output		
PA0			IOP IO		
PA1			IOP IO		
PA2			IOP IO		
PA3			IOP IO		
PB0			IOP IO		
PB1			IOP IO		
PB2			IOP IO		
PB3			IOP IO		
PC0	ICP IC	ONP ON			
PC1	ICP IC	ONP ON			
PD0	ICP IC	OC			
PD1	ICP IC	OC			
PD2	ICP IC	OC			
PD3	ICP IC	OC			
PE0	ICP IC	OC			
PE1	ICP IC	OC			
PE2	ICP IC	OC			
PE3	ICP IC	OC			

Note) The symbol in the above table is the same as in mask option generator software.

*1) The symbol and the detail circuits of INPUT OUTPUT TERMINAL are written in INPUT OUTPUT TERMINAL TYPE.

[CIRCUIT TYPE TABLE 2]

SYMBOL	TERMINAL TYPES				EXTRA FUNCTION	REMARKS
	Input / Output Terminal*1			Programmable Input / Output		
	Port of Input	Port of Output				
PF0	ISP IS	OC				
PF1	ISP IS	OC				
PF2	ISP IS	OC				
PG0	ISP IS	OC				
PG1	ISP IS	OC				
PH0	ISP IS	OC			Restart signal input	
PH1	ISP IS	OC			Edge detection	R Rise edge detection F Fall edge detection
AIN0 / PI0	ICP IC			AD	Analog input to ADC (AIN0)	
AIN1 / PI1	ICP IC			AD	Analog input to ADC (AIN1)	
AIN2 / PI2	ICP IC			AD	Analog input to ADC (AIN2)	
AIN3 / PI3	ICP IC			AD	Analog input to ADC (AIN3)	
V _{REF} / PJ0	ISP IS			AD	Reference input (V _{REF})	
ADCK / PJ1 *2	ISP IS			ACP AC	External clock input (ADCK)	
EXTI / PK0 *2	ISP IS			IIP II	External interrupt input (EXTI)	R Rise interrupt input F Fall interrupt input
CNT1 / PK1 *2	ISP IS			IIP II	External clock of Timer 2 input (CNT1)	
SDO / PL0		OC		SO	Serial data output	MSB MSB first
SDI(O) / PL1 *2	ICP IC	OC		SDP SD	Serial data input/output	LSB LSB first
SCK / CKOUT *2 *3				SCP SC -	Serial clock input/output Output clock divide by pre-scaler	

Note) The symbol in the above table is the same as in mask option generator software.

*1) The symbol and the detail circuits of INPUT OUTPUT TERMINAL are written in INPUT OUTPUT TERMINAL TYPE.

*2) The pull-up resistance is added to the terminal selected as the extra function.

*3) When Serial INPUT-OUTPUT is selected, "SCK" is selected automatically. When it is not selected, "CKOUT" is selected automatically.

[MASK OPTION LIST]

SYM BOL	FUNCTION
ICP	C-MOS input with pull-up resistance
ISP	C-MOS Schmitt trigger input with pull-up resistance
IC	C-MOS input
IS	C-MOS Schmitt trigger input
ONP	Nch-FET Open-Drain output with pull-up resistance
OC	C-MOS output
ON	Nch-FET Open-Drain output
IIP	External interrupt input with pull-up resistance
II	External interrupt input
SDP	Serial data input/output with pull-up resistance
SD	Serial data input/output
SO	Serial data output
SCP	Serial clock input/output with pull-up resistance
SC	Serial clock input/output
AD	A/D converter
ACP	External clock input with pull-up resistance for ADC
AC	External clock input for ADC
IOP	Programmable input/output with pull-up resistance
IO	Programmable input/output

SYM BOL	FUNCTION
R	Rise edge detection
F	Fall edge detection
MSB	Serial data order MSB first
LSB	Serial data order LSB first
1	1/2
2	1/4
3	1/8
4	1/16
5	1/32
6	1/64
7	1/128
8	1/256
9	1/512
a	1/1024
b	1/2048
c	1/4096

[INPUT OUTPUT TERMINAL TYPE]

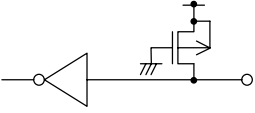
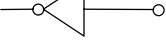
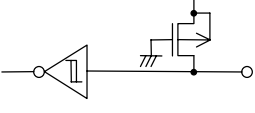
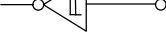
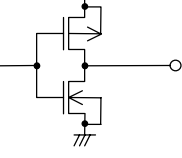
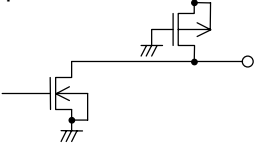
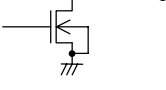
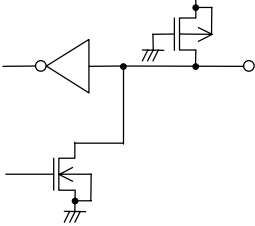
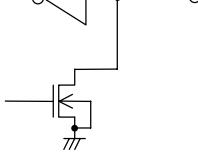
	Types	With Pull-up	Without Pull-up	Terminals	
INPUT TERMINAL	C-MOS	Type ICP 	Type IC 	PC0, PC1, PD0~PD3, PE0~PE3, AIN0/PI0~ AIN3/PI3, SDI(O)/PL1	
	SCHMITT TRIGGER	Type ISP 	Type IS 	PF0~PF2, PG0, PG1, PH0, PH1, V _{REF} /PJ0, ADCK/PJ1, EXTI/PK0, CNTI/PK1	
OUTPUT TERMINAL	C-MOS	/		Type ON 	PD0~PD3, PE0~PE3, PF0~PF2, PG0, PG1, PH0, PH1, SDO/PL0, SDI(O)/PL1
	N-channel(Nch) OPEN DRAIN	Type ONP 	Type ON 	PC0, PC1	
PROGRAMMABLE INPUT OUTPUT TERMINAL	C-MOS INPUT / Nch OPEN DRAIN OUTPUT	Type IOP 	Type IO 	PA0~PA3, PB0~PB3	

2) Edge Detector Selection

PH1 terminal is added the "Edge detect function" by the mask option.



3) The data order (MSB, LSB) of the Serial Interface

The data order of the Serial Interface is selected select either MSB or LSB first by the mask option.

4) A/D Control Clock

A/D Control Clock is selected either the external clock from ADCK terminal or the internal clock from the prescaler by the mask option.

5) Dividing ration of the internal clock

Each dividing ration of the count clocks of Timer1 and Timer2, the Internal shift clock of the Serial Interface, the clock of the A/D control clock and the output clock through the SCK/CKOUT terminal is selected among the following by the mask option.

The frequency of each clock is determined by the dividing ration and the 1-instruction term ($1/f_{OSC} \times 6$).

1/2, 1/4, 1/8, 1/16, 1/32, 1/64, 1/128, 1/256, 1/512, 1/1024, 1/2048, 1/4096

Note) As Timer2 clock, the external clock or the internal is selected by the program.

As the shift clock of the serial interface, the external clock or the internal is selected by the program.

[CAUTION]

The specifications on this databook are only given for information, without any guarantee as regards either mistakes or omissions. The application circuits in this databook are described only to show representative usages of the product and not intended for the guarantee or permission of any right including the industrial rights.