

4-BIT SINGLE CHIP OTP MICRO CONTROLLER

■ GENERAL DESCRIPTION

The **NJU3552** is the C-MOS 4-bit Single Chip OTP type Micro Controller with programmable Flash Memory.

It is completely compatible with the **NJU3502** in function and the pin configuration. Therefore, the **NJU3552** is suitable for the final evaluation before **NJU3502** mask generation, the small quantity production and short lead-time.

* *In this data sheet, only OTP programming and the difference between **NJU3552** and **NJU3502** are mentioned mainly. Therefore the detail function and specification should be referred on the **NJU3502** data sheet.*

■ PACKAGE OUTLINE

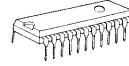

NJU3552L

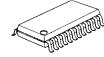

NJU3552M

■ FEATURES

- Internal One Time Programmable ROM 1,024 X 8bits
- Internal Data RAM 64 X 4bits
- Wide operating voltage range 2.7V ~ 5.5V
- Package outline SDIP24 / DMP24
- ROM programmer "SUPERPRO/L" by XELTEK co.,.

■ PIN CONFIGURATION IN OTP PROGRAMMING MODE

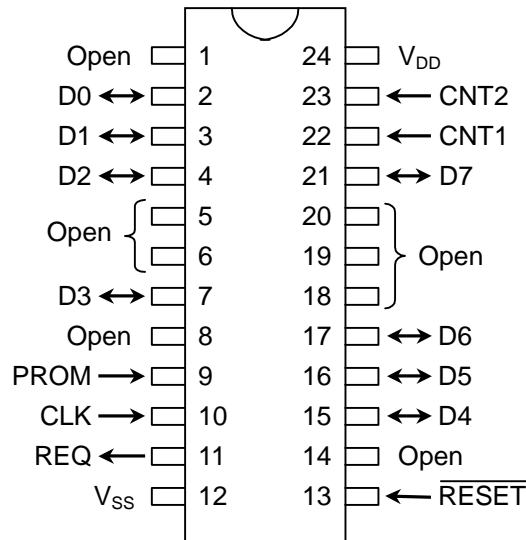

Note) The pin configuration in Normal operating mode is the same as **NJU3502**.

■ BLOCK DIAGRAM

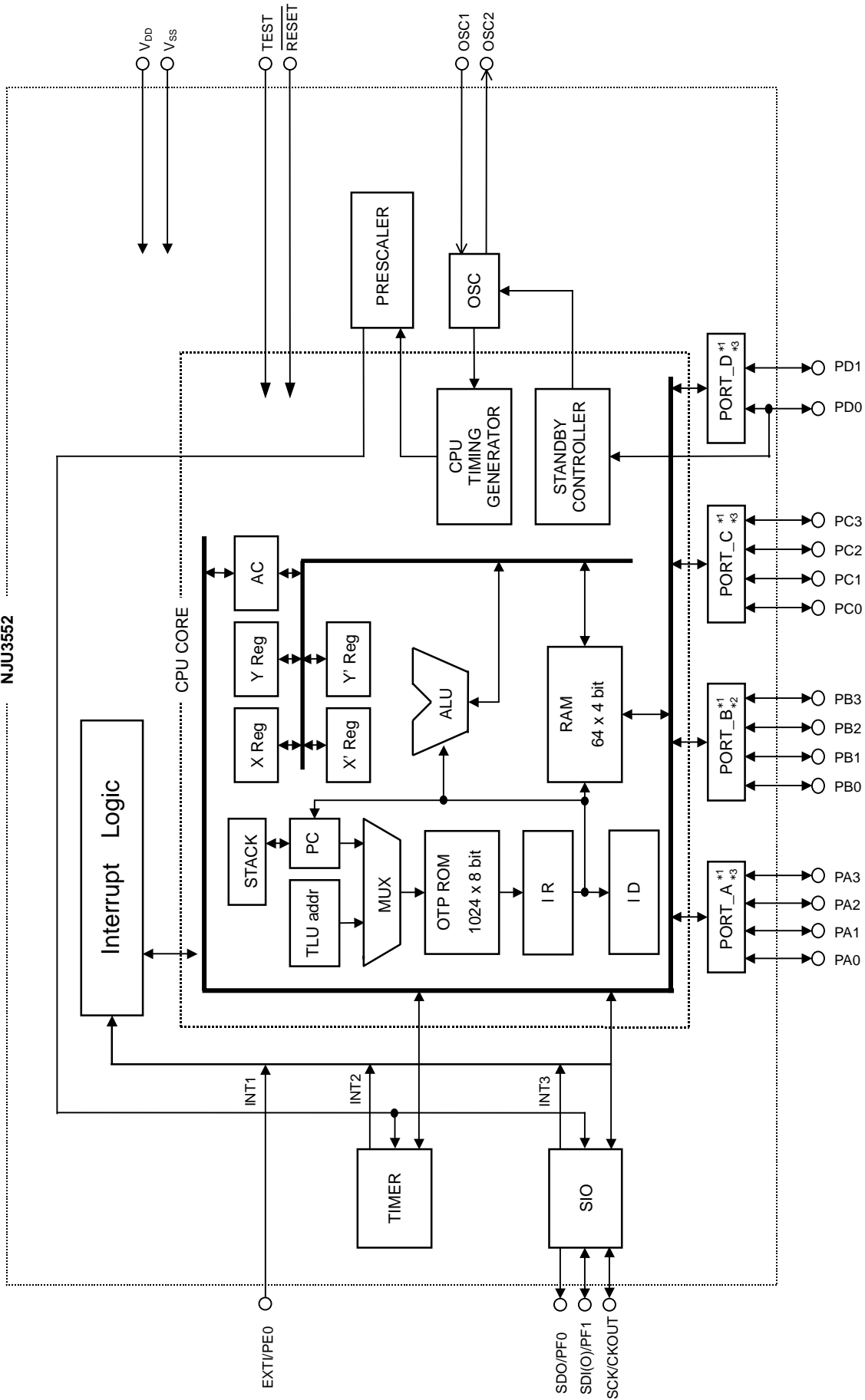

NJU3552

- *1 refer [INPUT OUTPUT TERMINAL TYPE]
- *2 Input / Output direction of 4-bit group is changed by the program.
- *3 Input / Output direction of each bit is selected by mask option.

■ TERMINAL DESCRIPTION IN OTP PROGRAMMING MODE

No.	SYMBOL	INPUT/OUTPUT	FUNCTION
13	$\overline{\text{RESET}}$	INPUT	RESET terminal. When the low-level input-signal, the system is initialized.
2 - 4, 7, 15 - 17, 21	D0 - D7	INPUT/OUTPUT	Data bus
22, 23	CNT1 CNT2	INPUT INPUT	OTP control input terminal
11	REQ	OUTPUT	Request output terminal
10	CLK	INPUT	Clock input terminal
9	PROM	INPUT	OTP programming enable terminal
24	V_{DD}	-	Power Source (5V)
12	V_{SS}	-	Power Source (0V)

- Note 1) Use at $V_{DD}=5V$ in OTP programming mode.
 2) Non connect anything to the other terminals.

■ Difference between NJU3552 (OTP version) and NJU3502 (MASK version)

● Operating mode

NJU3552 has two operating modes. One is "Normal operating mode" and the other is "OTP programming mode".

• Normal operating mode

The "TEST" terminal is set to low level. (The terminal is recommended to connect to GND.)
 Operating voltage range; 2.7V ~ 5.5V.

• OTP Programming mode

User program is read out from or written into the OTP by the universal programmer "SUPERPRO/L" and converting adapter made by XELTEK co.,(USA).

● Option information set in the initialization

When the initialization is performed($\overline{\text{RESET}}$ terminal is "L"), the operation information stored in option area is set as shown in the following timing chart. The option information is set in the term of **$1 / f_{osc} \times 256\text{clock}$** after RESET releasing and oscillation stability time. After information set, the program counter is set to 0000H and the **NJU3552** operates in normal.

[TIMING CHART]

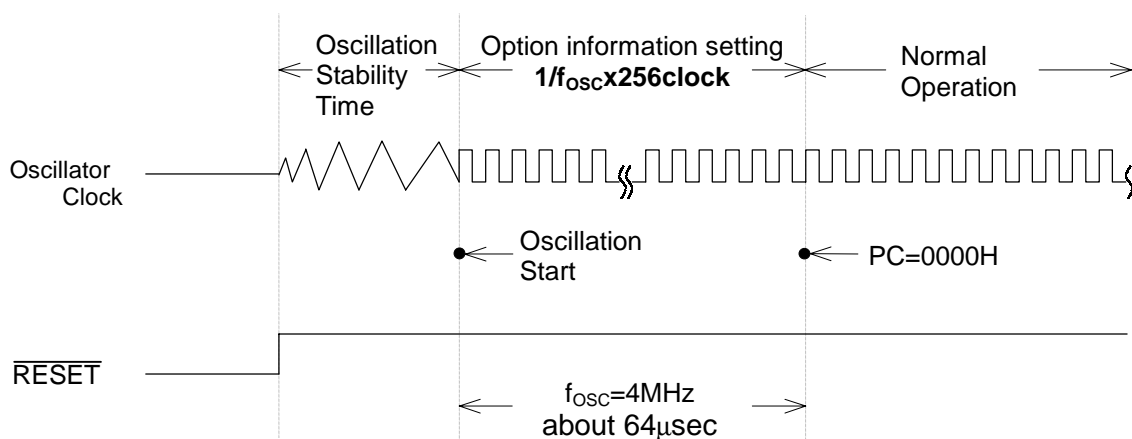

NJU3552

■ ABSOLUTE MAXIMUM RATINGS

(Ta=25°C)

PARAMETER	SYMBOL	RATINGS	UNIT
Supply Voltage	V _{DD}	-0.3 ~ +7.0	V
Input Voltage	V _{IN}	-0.3 ~ V _{DD} + 0.3	V
Output Voltage	V _{OUT}	-0.3 ~ V _{DD} + 0.3	V
Operating Temperature	T _{opr}	-20 ~ +75	°C
Storage Temperature	T _{stg}	-55 ~ +125	°C

Note)

The difference of electrical characteristics between **NJU3552** (OTP version) and **NJU3502** (MASK version)

	NJU3502		NJU3552
•Supply Voltage (V _{DD}) MIN.	2.4V	→	2.7V
•Supply Current			
5V (I _{DD1}) Max.	4.0mA	→	30mA
(I _{DD2}) Max.	4.0mA	→	30mA
(I _{DD3}) Max.	3.8mA	→	30mA
(I _{DD4}) Max.	4.0μA		20μA
3V (I _{DD1}) Max.	2.0mA	→	20mA
(I _{DD2}) Max.	2.0mA	→	20mA
(I _{DD3}) Max.	1.8mA		20mA
(I _{DD4}) Max.	2.0μA	→	20μA

■ ELECTRICAL CHARACTERISTICS DC CHARACTERISTICS 1

(V_{DD}=3.6~5.5V, V_{SS}=0V, Ta=-20~75°C)

PARAMETER	SYM BOL	CONDITIONS	MIN	TYP	MAX	UNIT	NOTE
Supply Voltage	V _{DD}	V _{DD}	3.6		5.5	V	
Supply Current	I _{DD1}	V _{DD} V _{DD} =5V, f _{OSC} =2MHz X'tal Oscillation in Reset			30	mA	*3
	I _{DD2}	V _{DD} V _{DD} =5V, f _{OSC} =2MHz Ceramic Oscillation in Reset			30	mA	*3
	I _{DD3}	V _{DD} V _{DD} =5V, f _{OSC} =2MHz CR Oscillation in Reset			30	mA	*3
	I _{DD4}	V _{DD} V _{DD} =5V, STANDBY Mode			20	μA	*3
	I _{DD5}	V _{DD} V _{DD} =5V, f _{OSC} =4MHz, Operating			30	mA	*3
High-Level Input Voltage	V _{IH1}	PA0~PA3, PB0~PB3, PC0~PC3, SDI(O)/PF1, SCK/CKOUT	0.7V _{DD}		V _{DD}	V	*1
	V _{IH2}	PD0, PD1, EXTI/PE0, $\overline{\text{RESET}}$	0.8V _{DD}		V _{DD}	V	*1
	V _{IH3}	OSC1	V _{DD} -1.0		V _{DD}	V	
Low-level Input Voltage	V _{IL1}	PA0~PA3, PB0~PB3, PC0~PC3, SDI(O)/PF1, SCK/CKOUT	0		0.3V _{DD}	V	*1
	V _{IL2}	PD0, PD1, EXTI/PE0, $\overline{\text{RESET}}$	0		0.2V _{DD}	V	*1
	V _{IL3}	OSC1	0		1.0	V	
High-Level Input Current	I _{IH}	V _{DD} =5.5V, V _{IN} =5.5V PA0~PA3, PB0~PB3, PC0~PC3, PD0, PD1, EXTI/PE0, SDI(O)/PF1, $\overline{\text{RESET}}$, SCK/CKOUT			10	μA	*1
Low-Level Input Current	I _{IL1}	V _{DD} =5.5V, V _{IN} =0V Without pull-up resistance PA0~PA3, PB0~PB3, PC0~PC3, PD0, PD1, EXTI/PE0, SDI(O)/PF1, $\overline{\text{RESET}}$			-10	μA	*1
	I _{IL2}	V _{DD} =5.5V, V _{IN} =0V With pull-up resistance PA0~PA3, PB0~PB3, PC0~PC3, PD0, PD1, EXTI/PE0, SDI(O)/PF1, SCK/CKOUT			-100	μA	*1
High-Level Output Voltage	V _{OH}	I _{OH} =-100μA PA0~PA3, PC0~PC3, PD0, PD1, SDO/PF0, SDI(O)/PF1, SCK/CKOUT	V _{DD} -0.5			V	*2
Low-Level Output Voltage	V _{OL1}	I _{OL1} =400μA PA0~PA3, PC0~PC3, PD0, PD1, SDO/PF0, SDI(O)/PF1, SCK/CKOUT			0.5	V	*2
	V _{OL2}	I _{OL2} =15mA PB0~PB3			2.0	V	*2
Output Leakage Current	I _{OD}	V _{DD} =5.5V, V _{OH} =5.5V PB0~PB3			10	μA	*2
Input Capacitance	C _{IN}	Except V _{DD} , V _{SS} terminals f _{OSC} =1MHz Other terminals : 0V		10	20	pF	

*1 Input/output port is set as an Input terminal.

*2 Input/output port is set as an Output terminal.

*3 Except the current through Pull-up resistor.

ELECTRICAL CHARACTERISTICS DC CHARACTERISTICS 2

($V_{DD}=2.7\sim 3.6V$, $V_{SS}=0V$, $T_a=-20\sim 75^{\circ}C$)

PARAMETER	SYM BOL	CONDITIONS	MIN	TYP	MAX	UNIT	NOTE
Supply Voltage	V_{DD}	V_{DD}	2.7		3.6	V	
Supply Current	I_{DD1}	V_{DD} $V_{DD}=3V$, $f_{OSC}=1MHz$ X'tal Oscillation in Reset			20	mA	*3
	I_{DD2}	V_{DD} $V_{DD}=3V$, $f_{OSC}=1MHz$ Ceramic Oscillation in Reset			20	mA	*3
	I_{DD3}	V_{DD} $V_{DD}=3V$, $f_{OSC}=1MHz$ CR Oscillation in Reset			20	mA	*3
	I_{DD4}	V_{DD} $V_{DD}=3V$, STANDBY Mode			20	μA	*3
	I_{DD5}	V_{DD} $V_{DD}=3V$, $f_{OSC}=2MHz$, Operating			20	mA	*3
High-Level Input Voltage	V_{IH1}	PA0~PA3, PB0~PB3, PC0~PC1, SDI(O)/PL1, SCK/CKOUT	$0.8V_{DD}$		V_{DD}	V	*1
	V_{IH2}	PD0, PD1, EXTI/PE0, \overline{RESET}	$0.85V_{DD}$		V_{DD}	V	*1
	V_{IH3}	OSC1	$V_{DD}-0.3$		V_{DD}	V	
Low-level Input Voltage	V_{IL1}	PA0~PA3, PB0~PB3, PC0~PC3, SDI(O)/PF1, SCK/CKOUT	0		$0.2V_{DD}$	V	*1
	V_{IL2}	PD0, PD1, EXTI/PE0, \overline{RESET}	0		$0.15V_{DD}$	V	*1
	V_{IL3}	OSC1	0		0.3	V	
High-Level Input Current	I_{IH}	$V_{DD}=3.6V$, $V_{IN}=3.6V$ PA0~PA3, PB0~PB3, PC0~PC3, PD0, PD1, EXTI/PE0, SDI(O)/PF1, \overline{RESET} , SCK/CKOUT			10	μA	*1
Low-Level Input Current	I_{IL1}	$V_{DD}=3.6V$, $V_{IN}=0V$ Without pull-up resistance PA0~PA3, PB0~PB3, PC0~PC3, PD0, PD1, EXTI/PE0, SDI(O)/PF1, \overline{RESET}			-10	μA	*1
	I_{IL2}	$V_{DD}=3.6V$, $V_{IN}=0V$ With pull-up resistance PA0~PA3, PB0~PB3, PC0~PC3, PD0, PD1, EXTI/PE0, SDI(O)/PF1, SCK/CKOUT			-100	μA	*1
High-Level Output Voltage	V_{OH}	$I_{OH}=-80\mu A$ PA0~PA3, PC0~PC3, PD0, PD1, SDO/PF0, SDI(O)/PF1, SCK/CKOUT	$V_{DD}-0.5$			V	*2
Low-Level Output Voltage	V_{OL1}	$I_{OL1}=350\mu A$ PA0~PA3, PC0~PC3, PD0, PD1, SDO/PF0, SDI(O)/PF1, SCK/CKOUT			0.5	V	*2
	V_{OL2}	$I_{OL2}=5mA$ PB0~PB3			1.0	V	*2
Output Leakage Current	I_{OD}	$V_{DD}=3.6V$, $V_{OH}=3.6V$ PB0~PB3			10	μA	*2
Input Capacitance	C_{IN}	Except V_{DD} , V_{SS} terminals $f_{OSC}=1MHz$ Other terminals : 0V		10	20	pF	

*1 Input/output port is set as an Input terminal.

*2 Input/output port is set as an Output terminal.

*3 Except the current through Pull-up resistor.

■ ELECTRICAL CHARACTERISTICS AC CHARACTERISTICS 1

(V_{SS}=0V, T_a= -20~75°C)

PARAMETER	SYM BOL	CONDITIONS		MIN	TYP	MAX	UNIT
Operating Frequency	f _{OSC}	V _{DD} =2.7~3.6V	X'tal Resonator	0.03		2.0	MHz
			Ceramic Resonator	0.03		2.0	
			External Resistor Oscillation	0.03		1.0	
			External Clock	0.03		2.0	
		V _{DD} =3.6~5.5V	X'tal Resonator	0.03		4.0	
			Ceramic Resonator	0.03		4.0	
			External Resistor Oscillation	0.03		2.0	
			External Clock	0.03		4.0	
Instruction Cycle Time	t _C			6/f _{OSC}		s	
External Clock Pulse Width	t _{CPH}	V _{DD} =2.7~3.6V		250		16600	ns
	t _{CPL}	V _{DD} =3.6~5.5V		125		16600	
External Clock Rise Time Fall Time	t _{CPR}	V _{DD} =2.7~5.5V				20	ns
	t _{CPF}						
RESET Low-Level Width	t _{RST}	V _{DD} =2.7~5.5V		4/f _{OSC}			s
RESET Rise Time	t _{RSR}	V _{DD} =2.7~5.5V				20	ms
Port Input Level Width	t _{PIN}	V _{DD} =2.7~5.5V		6/f _{OSC}			s
Edge Detection (PD1) Rise Time Fall Time	t _{EDR}	V _{DD} =2.7~5.5V				200	ns
	t _{EDF}						
Restart Signal (PD0) Rise Time	t _{STR}	V _{DD} =2.7~5.5V				200	ns
External interrupt input (EXTI) Rise Time	t _{EXR}	V _{DD} =2.7~5.5V				200	ns

■ AC CHARACTERISTICS 1 TIMING CHART

EXTERNAL CLOCK

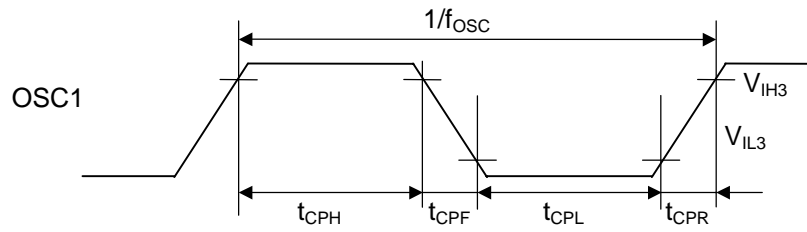

RESET INPUT

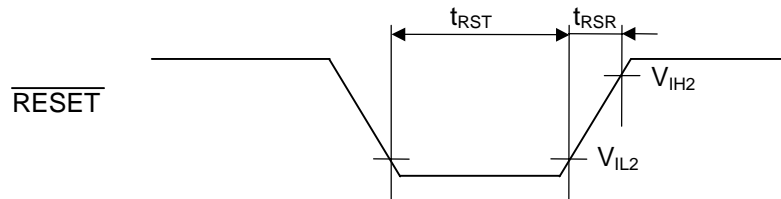

PORT INPUT

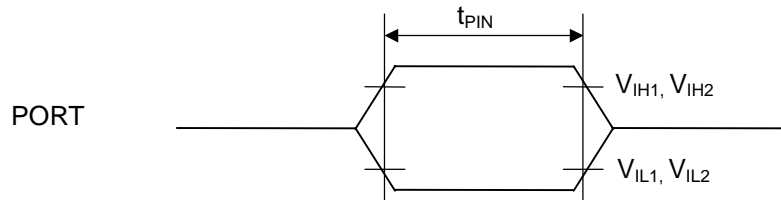

EDGE DETECTOR INPUT

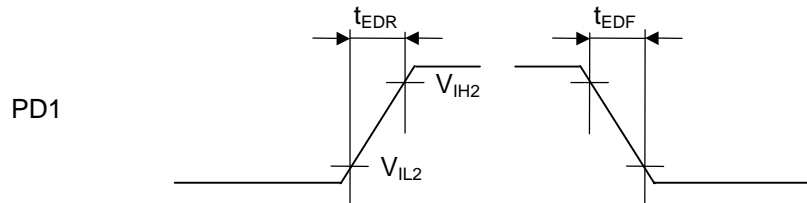

RESTART SIGNAL INPUT

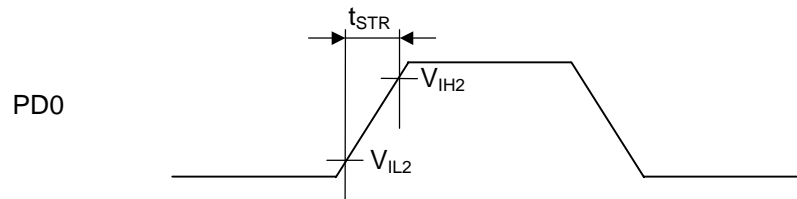

EXTERNAL INTERRUPT

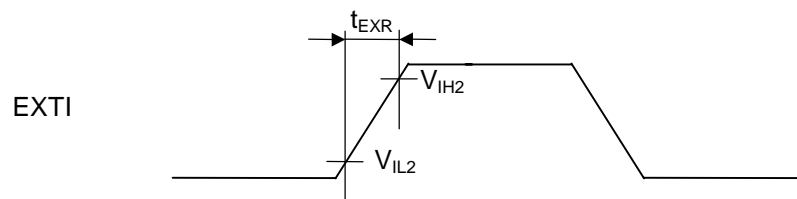

■ ELECTRICAL CHARACTERISTICS AC CHARACTERISTICS 2 SERIAL INTERFACE

($V_{SS}=0V$, $V_{DD}=2.7\sim 5.5V$, $T_a=-20\sim 75^\circ C$)

PARAMETER	SYM BOL	CONDITIONS		MIN	TYP	MAX	UNIT
Serial Operating Frequency	f_{sc}	Internal Clock				$(1/12) \times f_{osc}^*$	Hz
		External Clock				500k	
Clock Pulse Width Low-Level	t_{scl}	Internal Clock	$V_{DD}=2.7\sim 3.6V$ $f_{osc}=2MHz$	3.0			μs
			$V_{DD}=3.6\sim 5.5V$ $f_{osc}=4MHz$	1.5			
		External Clock		1.0			
Clock Pulse Width High-Level	t_{sch}	Internal Clock	$V_{DD}=2.7\sim 3.6V$ $f_{osc}=2MHz$	3.0			μs
			$V_{DD}=3.6\sim 5.5V$ $f_{osc}=4MHz$	1.5			
		External Clock		1.0			
SDI setup Time To SCK	t_{ds}			0.5			μs
SDI Hold time To SCK	t_{dh}			0.5			μs
SDO Data Fix Time To SCK	t_{dcd}					0.5	μs

* The dividing ratio of the internal clock is 1/2.

■ AC CHARACTERISTICS 2 SERIAL INTERFACE TIMING CHART

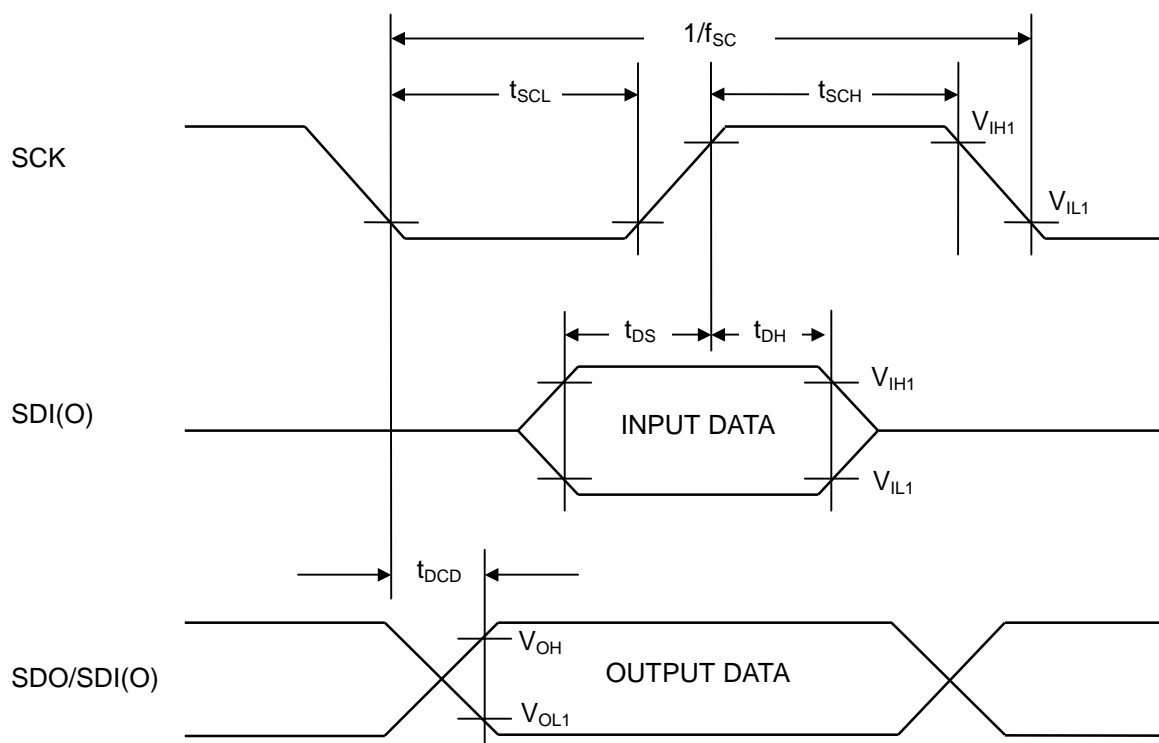

NJU3552

■ OPTION as same as mask version (NJU3502)

1) INPUT OUTPUT Terminal Selection

All of input-output terminals select a terminal type for each port from the following table1 and table2 by the mask option.

[CIRCUIT TYPE TABLE 1]

SYMBOL	TERMINAL TYPES			EXTRA FUNCTION	REMARKS
	Input / Output Terminal*1				
	Port of Input	Port of Output	Programmable Input / Output		
PA0	ICP IC	OC			
PA1	ICP IC	OC			
PA2	ICP IC	OC			
PA3	ICP IC	OC			
PB0			IOP IO		
PB1			IOP IO		
PB2			IOP IO		
PB3			IOP IO		
PC0	ICP IC	OC			
PC1	ICP IC	OC			
PC2	ICP IC	OC			
PC3	ICP IC	OC			

Note) The symbol in the above table is the same as in mask option generator software.

*1) The symbol and the detail circuits of INPUT OUTPUT TERMINAL are written in INPUT OUTPUT TERMINAL TYPE.

[CIRCUIT TYPE TABLE 2]

SYMBOL	TERMINAL TYPES				EXTRA FUNCTION	REMARKS	
	Input / Output Terminal*1			Programmable Input / Output			
	Port of Input	Port of Output					
PD0	ISP IS	OC			Restart signal input		
PD1	ISP IS	OC			Edge detection	R F	Rise edge detection Fall edge detection
EXTI / PE0 *2	ISP IS			IIP II	External interrupt input (EXTI)		
SDO / PF0		OC		SO	Serial data output	MSB	MSB first
SDI(O) / PF1 *2	ICP IC	OC		SDP SD	Serial data input/output	LSB	LSB first
SCK / CKOUT *2 *3				SCP SC -	Serial clock input/output Output clock divide by pre-scaler		

Note) The symbol in the above table is the same as in mask option generator software.

*1) The symbol and the detail circuits of INPUT OUTPUT TERMINAL are written in INPUT OUTPUT TERMINAL TYPE.

*2) The pull-up resistance is added to the terminal selected as the extra function.

*3) When Serial INPUT-OUTPUT is selected, "SCK" is selected automatically. When it is not selected, "CKOUT" is selected automatically.

[MASK OPTION LIST]

SYM BOL	FUNCTION
ICP	C-MOS input with pull-up resistance
ISP	C-MOS Schmitt trigger input with pull-up resistance
IC	C-MOS input
IS	C-MOS Schmitt trigger input
OC	C-MOS output
IIP	External interrupt input with pull-up resistance
II	External interrupt input
SDP	Serial data input/output with pull-up resistance
SD	Serial data input/output
SO	Serial data output
SCP	Serial clock input/output with pull-up resistance
SC	Serial clock input/output
IOP	Programmable input/output with pull-up resistance
IO	Programmable input/output
R	Rise edge detection
F	Fall edge detection

SYM BOL	FUNCTION
MSB	Serial data order MSB first
LSB	Serial data order LSB first
1	1/2
2	1/4
3	1/8
4	1/16
5	1/32
6	1/64
7	1/128
8	1/256
9	1/512
a	1/1024
b	1/2048
c	1/4096

[INPUT OUTPUT TERMINAL TYPE]

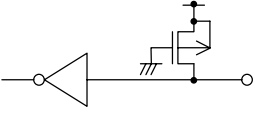
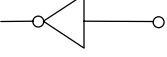
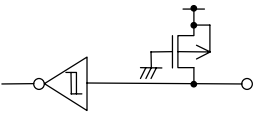
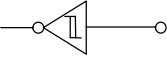
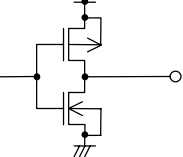
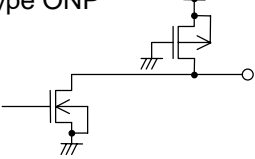
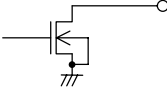
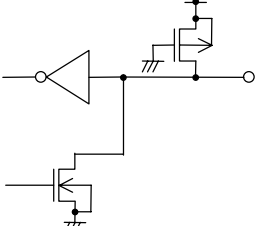
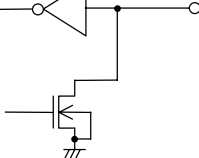
	Types	With Pull-up	Without Pull-up	Terminals
INPUT TERMINAL	C-MOS	Type ICP 	Type IC 	PA0~PA3, PC0~PC3, SDI(O)/PF1
	SCHMITT TRIGGER	Type ISP 	Type IS 	PD0, PD1, EXTI/PE0
OUTPUT TERMINAL	C-MOS	/	Type ON 	PA0~PA3, PC0~PC3, PD0, PD1, SDO/PF0, SDI(O)/PF1
	N-channel(Nch) OPEN DRAIN	Type ONP 	Type ON 	
PROGRAMMABLE INPUT OUTPUT TERMINAL	C-MOS INPUT / Nch OPEN DRAIN OUTPUT	Type IOP 	Type IO 	PB0~PB3

2) Edge Detector Selection

PD1 terminal is added the "Edge detect function" by the mask option.



3) The data order (MSB, LSB) of the Serial Interface

The data order of the Serial Interface is selected select either MSB or LSB first by the mask option.

4) Dividing ration of the internal clock

Each dividing ration of the count clocks of Timer, the Internal shift clock of the Serial Interface and the output clock through the SCK/CKOUT terminal is selected among the following by the mask option.

The frequency of each clock is determined by the dividing ration and the 1-instruction term ($1/f_{OSC} \times 6$).

1/2, 1/4, 1/8, 1/16, 1/32, 1/64, 1/128, 1/256, 1/512, 1/1024, 1/2048, 1/4096

Note) As the shift clock of the serial interface, the external clock or the internal is selected by the program.

[CAUTION]

The specifications on this databook are only given for information , without any guarantee as regards either mistakes or omissions. The application circuits in this databook are described only to show representative usages of the product and not intended for the guarantee or permission of any right including the industrial rights.