

4-BIT SINGLE CHIP OTP TINY CONTROLLER

■ GENERAL DESCRIPTION

The **NJU3152** is the C-MOS 4-bit Single Chip OTP type Micro Controller with programmable Flash Memory.

It is completely compatible with the **NJU3102** in function and the pin configuration. Therefore, the **NJU3152** is suitable for the final evaluation before **NJU3102** mask generation, the small quantity production and short lead-time.

* In this data sheet, only OTP programming and the difference between **NJU3152** and **NJU3102** are mentioned mainly. Therefore the detail function and specification should be referred on the **NJU3102** data sheet.

■ PACKAGE OUTLINE

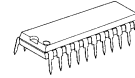

NJU3152L

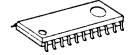

NJU3152G

■ FEATURES

- Internal One Time Programmable ROM 1,024 X 8bits
- Internal Data RAM 32 X 4bits
- Wide operating voltage range 2.7V ~ 5.5V
- Package outline SDIP22 / SOP22
- ROM programmer "SUPERPRO/L" by XELTEK co.,

■ PIN CONFIGURATION IN OTP PROGRAMMING MODE

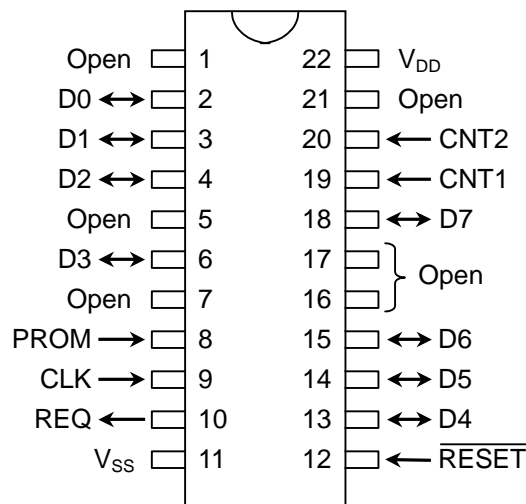

Note) The pin configuration in Normal operating mode is the same as **NJU3102**.

■ BLOCK DIAGRAM

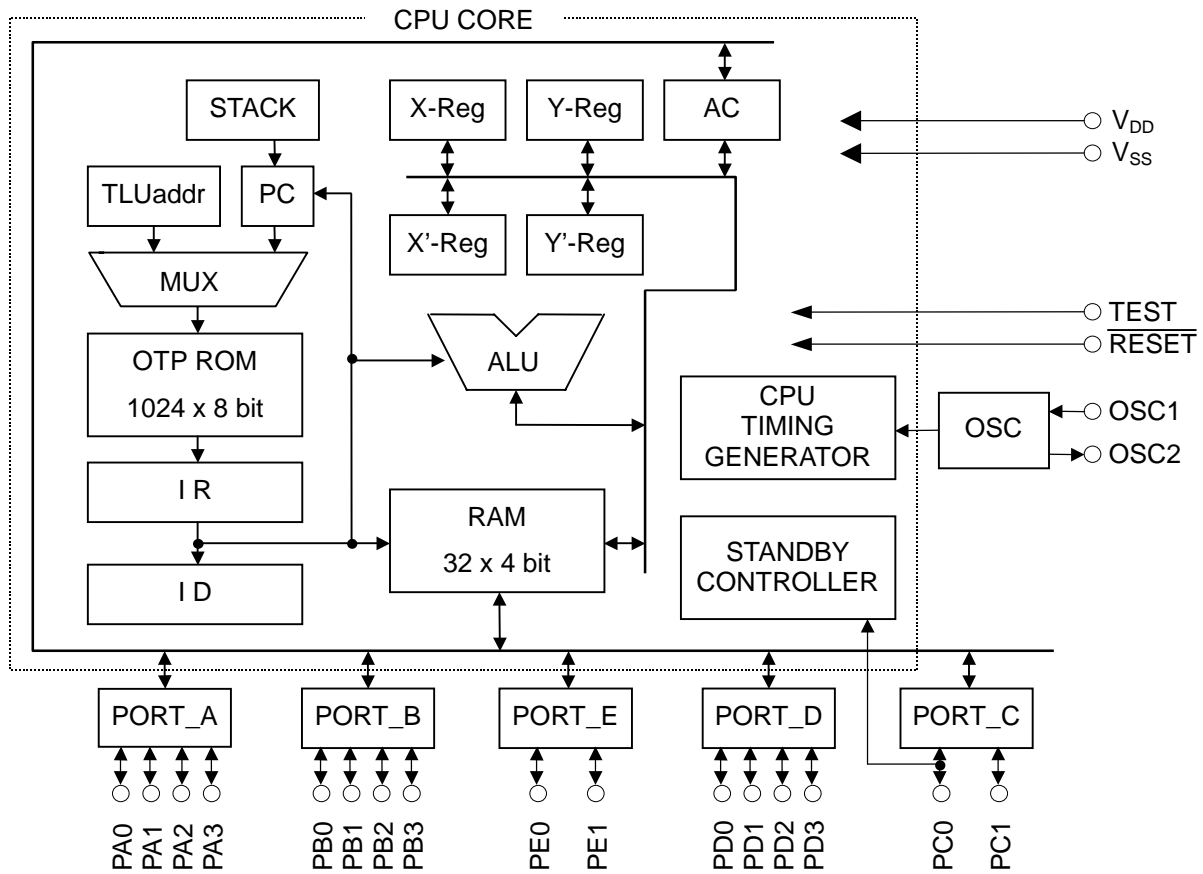

■ TERMINAL DESCRIPTION IN OTP PROGRAMMING MODE

No.	SYMBOL	INPUT/OUTPUT	FUNCTION
12	$\overline{\text{RESET}}$	INPUT	RESET terminal. When the low-level input-signal, the system is initialized.
2 - 4, 6, 13 - 15, 18	D0 - D7	INPUT/OUTPUT	Data bus
19, 20	CNT1 CNT2	INPUT INPUT	OTP control input terminal
10	REQ	OUTPUT	Request output terminal
9	CLK	INPUT	Clock input terminal
8	PROM	INPUT	OTP programming enable terminal
22	V_{DD}	-	Power Source (5V)
11	V_{SS}	-	Power Source (0V)

- Note 1) Use at $V_{DD}=5V$ in OTP programming mode.
 2) Non connect anything to the other terminals.

■ Difference between NJU3152 (OTP version) and NJU3102 (MASK version)

● Operating mode

NJU3152 has two operating modes. One is "Normal operating mode" and the other is "OTP programming mode".

• Normal operating mode

The "TEST" terminal is set to low level. (The terminal is recommended to connect to GND.)
 Operating voltage range; 2.7V ~ 5.5V.

• OTP Programming mode

User program is read out from or written into the OTP by the universal programmer "SUPERPRO/L" and converting adapter made by XELTEK co.,(USA).

● Option information set in the initialization

When the initialization is performed($\overline{\text{RESET}}$ terminal is "L"), the operation information stored in option area is set as shown in the following timing chart. The option information is set in the term of **$1/f_{osc} \times 256\text{clock}$** after RESET releasing and oscillation stability time. After information set, the program counter is set to 0000H and the **NJU3152** operates in normal.

[TIMING CHART]

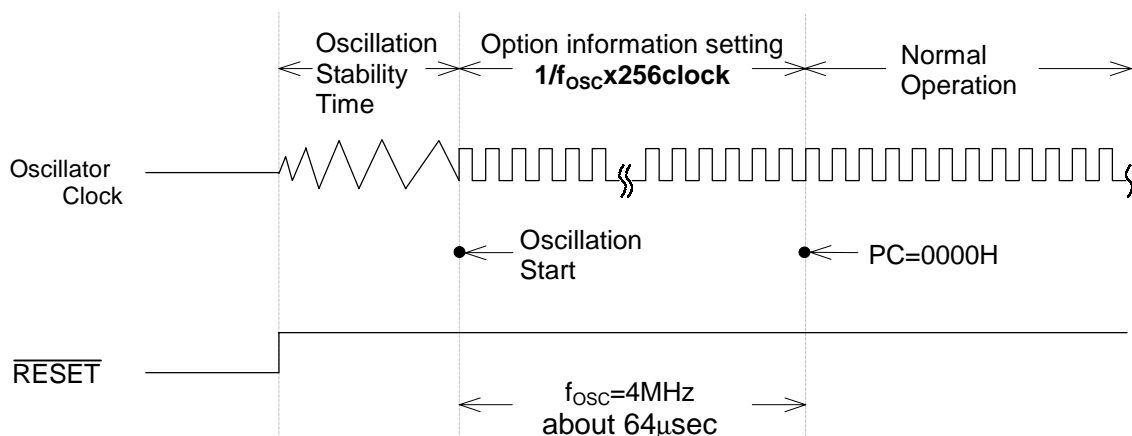

NJU3152

■ ABSOLUTE MAXIMUM RATINGS

(Ta=25°C)

PARAMETER	SYMBOL	RATINGS	UNIT
Supply Voltage	V _{DD}	-0.3 ~ +7.0	V
Input Voltage	V _{IN}	-0.3 ~ V _{DD} + 0.3	V
Output Voltage	V _{OUT}	-0.3 ~ V _{DD} + 0.3	V
Operating Temperature	T _{opr}	-20 ~ +75	°C
Storage Temperature	T _{stg}	-55 ~ +125	°C

Note)

The difference of electrical characteristics between **NJU3152** (OTP version) and **NJU3102** (MASK version)

	NJU3102		NJU3152
•Supply Voltage (V _{DD}) MIN.	2.4V	→	2.7V
•Supply Current			
5V (I _{DD1}) Max.	4.5mA	→	30mA
(I _{DD2}) Max.	4.5mA	→	30mA
(I _{DD3}) Max.	4.3mA	→	30mA
(I _{DD4}) Max.	5.0μA		20μA
3V (I _{DD1}) Max.	2.3mA	→	20mA
(I _{DD2}) Max.	2.3mA	→	20mA
(I _{DD3}) Max.	2.1mA		20mA
(I _{DD4}) Max.	3.0μA	→	20μA

■ ELECTRICAL CHARACTERISTICS DC CHARACTERISTICS 1

(V_{DD}=3.6~5.5V, V_{SS}=0V, Ta=-20~75°C)

PARAMETER	SYM BOL	CON DITIONS	MIN	TYP	MAX	UNIT	NOT E
Supply Voltage	V _{DD}	V _{DD}	3.6		5.5	V	
Supply Current	I _{DD1}	V _{DD} V _{DD} =5V, f _{OSC} =2MHz X'tal Oscillation in Reset			30	mA	*3
	I _{DD2}	V _{DD} V _{DD} =5V, f _{OSC} =2MHz Ceramic Oscillation in Reset			30	mA	*3
	I _{DD3}	V _{DD} V _{DD} =5V, f _{OSC} =2MHz CR Oscillation in Reset			30	mA	*3
	I _{DD4}	V _{DD} V _{DD} =5V, STANDBY Mode			20	μA	*3
	I _{DD5}	V _{DD} V _{DD} =5V, f _{OSC} =4MHz, Operating			30	mA	*3
High-Level Input Voltage	V _{IH1}	PA0~PA3, PB0~PB3, PC0, PC1, PD0~PD3	0.7V _{DD}		V _{DD}	V	*1
	V _{IH2}	PE0, PE1, RESET	0.8V _{DD}		V _{DD}	V	*1
	V _{IH3}	OSC1	V _{DD} -1.0		V _{DD}	V	
Low-level Input Voltage	V _{IL1}	PA0~PA3, PB0~PB3, PC0, PC1, PD0~PD3	0		0.3V _{DD}	V	*1
	V _{IL2}	PE0, PE1, RESET	0		0.2V _{DD}	V	*1
	V _{IL3}	OSC1	0		1.0	V	
High-Level Input Current	I _{IH}	V _{DD} =5.5V, V _{IN} =5.5V PA0~PA3, PB0~PB3, PC0, PC1, PD0~PD3, PE0, PE1, RESET			10	μA	*1
Low-Level Input Current	I _{IL1}	V _{DD} =5.5V, V _{IN} =0V Without pull-up resistance PA0~PA3, PB0~PB3, PC0, PC1, PD0~PD3, PE0, PE1, RESET			-10	μA	*1
	I _{IL2}	V _{DD} =5.5V, V _{IN} =0V With pull-up resistance PA0~PA3, PB0~PB3, PC0, PC1, PD0~PD3, PE0, PE1			-100	μA	*1
High-Level Output Voltage	V _{OH}	I _{OH} =-100μA PA0~PA3, PB0~PB3, PC0, PC1, PD0~PD3, PE0, PE1	V _{DD} -0.5			V	*2
Low-Level Output Voltage	V _{OL1}	I _{OL1} =400μA PA0~PA3, PB0~PB3, PC0, PC1, PE0, PE1			0.5	V	*2
	V _{OL2}	I _{OL2} =15mA PD0~PD3			2.0	V	*2
Output Leakage Current	I _{OD}	V _{DD} =5.5V, V _{OH} =5.5V PD0~PD3			10	μA	*2
Input Capacitance	C _{IN}	Except V _{DD} , V _{SS} terminals f _{OSC} =1MHz Other terminals : 0V		10	20	pF	

*1 Input/output port is set as an Input terminal.

*2 Input/output port is set as an Output terminal.

*3 Except the current through Pull-up resistor.

■ ELECTRICAL CHARACTERISTICS DC CHARACTERISTICS 2

($V_{DD}=2.7\sim 3.6V$, $V_{SS}=0V$, $T_a=-20\sim 75^{\circ}C$)

PARAMETER	SYM BOL	CONDITIONS	MIN	TYP	MAX	UNIT	NOTE
Supply Voltage	V_{DD}	V_{DD}	2.7		3.6	V	
Supply Current	I_{DD1}	V_{DD} $V_{DD}=3V$, $f_{OSC}=1MHz$ X'tal Oscillation in Reset			20	mA	*3
	I_{DD2}	V_{DD} $V_{DD}=3V$, $f_{OSC}=1MHz$ Ceramic Oscillation in Reset			20	mA	*3
	I_{DD3}	V_{DD} $V_{DD}=3V$, $f_{OSC}=1MHz$ CR Oscillation in Reset			20	mA	*3
	I_{DD4}	V_{DD} $V_{DD}=3V$, STANDBY Mode			20	μA	*3
	I_{DD5}	V_{DD} $V_{DD}=3V$, $f_{OSC}=4MHz$, Operating			20	mA	*3
High-Level Input Voltage	V_{IH1}	PA0~PA3, PB0~PB3, PC0, PC1, PD0~PD3	$0.8V_{DD}$		V_{DD}	V	*1
	V_{IH2}	PE0, PE1, RESET	$0.85V_{DD}$		V_{DD}	V	*1
	V_{IH3}	OSC1	$V_{DD}-0.3$		V_{DD}	V	
Low-level Input Voltage	V_{IL1}	PA0~PA3, PB0~PB3, PC0, PC1, PD0~PD3	0		$0.2V_{DD}$	V	*1
	V_{IL2}	PE0, PE1, RESET	0		$0.15V_{DD}$	V	*1
	V_{IL3}	OSC1	0		0.3	V	
High-Level Input Current	I_{IH}	$V_{DD}=3.6V$, $V_{IN}=3.6V$ PA0~PA3, PB0~PB3, PC0, PC1, PD0~PD3, PE0, PE1, RESET			10	μA	*1
Low-Level Input Current	I_{IL1}	$V_{DD}=3.6V$, $V_{IN}=0V$ Without pull-up resistance PA0~PA3, PB0~PB3, PC0, PC1, PD0~PD3, PE0, PE1, RESET			-10	μA	*1
	I_{IL2}	$V_{DD}=3.6V$, $V_{IN}=0V$ With pull-up resistance PA0~PA3, PB0~PB3, PC0, PC1, PD0~PD3, PE0, PE1			-100	μA	*1
High-Level Output Voltage	V_{OH}	$I_{OH}=-80\mu A$ PA0~PA3, PB0~PB3, PC0, PC1, PD0~PD3, PE0, PE1	$V_{DD}-0.5$			V	*2
Low-Level Output Voltage	V_{OL1}	$I_{OL1}=350\mu A$ PA0~PA3, PB0~PB3, PC0, PC1, PE0, PE1			0.5	V	*2
	V_{OL2}	$I_{OL2}=5mA$ PD0~PD3			1.0	V	*2
Output Leakage Current	I_{OD}	$V_{DD}=3.6V$, $V_{OH}=3.6V$ PD0~PD3			10	μA	*2
Input Capacitance	C_{IN}	Except V_{DD} , V_{SS} terminals $f_{OSC}=1MHz$ Other terminals : 0V		10	20	pF	

*1 Input/output port is set as an Input terminal.

*2 Input/output port is set as an Output terminal.

*3 Except the current through Pull-up resistor.

■ ELECTRICAL CHARACTERISTICS AC CHARACTERISTICS 1

(V_{SS}=0V, T_a= -20~75°C)

PARAMETER	SYM BOL	CONDITIONS		MIN	TYP	MAX	UNIT
Operating Frequency	f _{OSC}	V _{DD} =2.7~3.6V	X'tal Resonator	0.03		2.0	MHz
			Ceramic Resonator	0.03		2.0	
			External Resistor Oscillation	0.03		1.0	
			External Clock	0.03		2.0	
		V _{DD} =3.6~5.5V	X'tal Resonator	0.03		4.0	
			Ceramic Resonator	0.03		4.0	
			External Resistor Oscillation	0.03		2.0	
			External Clock	0.03		4.0	
Instruction Cycle Time	t _c			6/f _{OSC}		s	
External Clock Pulse Width	t _{CPH} t _{CPL}	V _{DD} =2.7~3.6V	250		16600	ns	
		V _{DD} =3.6~5.5V	125		16600		
External Clock Rise Time Fall Time	t _{CPR} t _{CPF}	V _{DD} =2.7~5.5V			20	ns	
RESET Low-Level Width	t _{RST}	V _{DD} =2.7~5.5V	4/f _{OSC}			s	
RESET Rise Time	t _{RSR}	V _{DD} =2.7~5.5V			20	ms	
Port Input Level Width	t _{PIN}	V _{DD} =2.7~5.5V	6/f _{OSC}			s	
Edge Detection (PC1) Rise Time Fall Time	t _{EDR} t _{EDF}	V _{DD} =2.7~5.5V			200	ns	
Restart Signal (PC0) Rise Time	t _{STR}	V _{DD} =2.7~5.5V			200	ns	

■ AC CHARACTERISTICS 1 TIMING CHART

EXTERNAL CLOCK

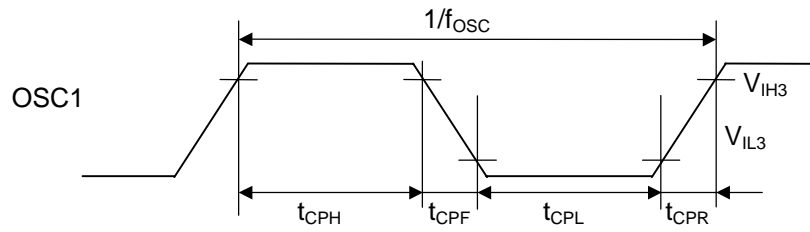

RESET INPUT

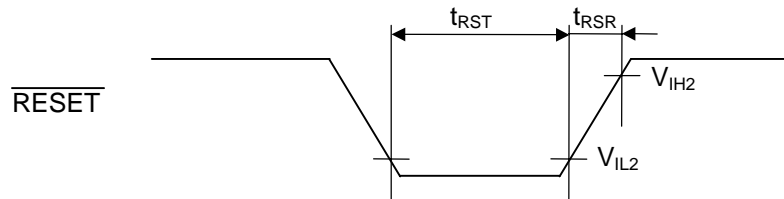

PORT INPUT

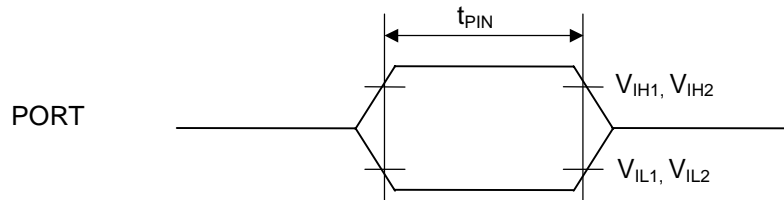

EDGE DETECTOR INPUT

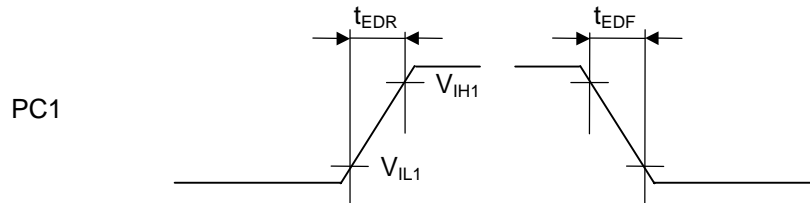

RESTART SIGNAL INPUT

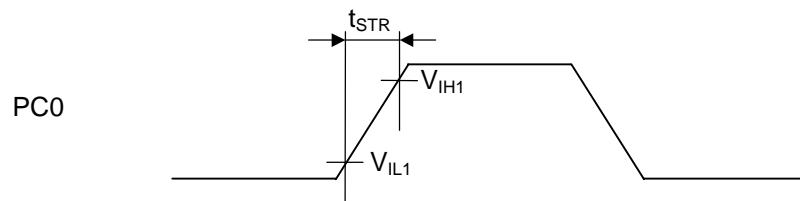

■ **OPTION as same as mask version (NJU3102)**

1) INPUT OUTPUT Terminal Selection

All of input-output terminals select a terminal type from the following table for each group as a PORT by the mask option.

[CIRCUIT TYPE TABLE]

SYMBOL	TERMINAL TYPES				REMARKS
	Input / Output Terminal*1		EXTRA FUNCTION		
	Port of Input	Port of Output			
Port A (PA0~PA3)	ICP IC	OC			
Port B (PB0~PB3)	ICP IC	OC			
Port C (PC0, PC1)	ICP IC	OC	Restart signal input *2 Edge detection *2	R F	Rise edge detection Fall edge detection
Port D (PD0~PD3)	ICP IC	ONP ON			
Port E (PE0, PE1)	ISP IS	OC			

Note) The symbol in the above table is the same as in mask option generator software.

*1) The symbol and the detail circuits of INPUT OUTPUT TERMINAL are written in INPUT OUTPUT TERMINAL TYPE.

*2) When the PORTC(PHY3) is set as the input, the extra function are added for terminals.

[MASK OPTION LIST]

記号	機能
ICP	C-MOS input with pull-up resistance
ISP	C-MOS Schmitt trigger input with pull-up resistance
IC	C-MOS input
IS	C-MOS Schmitt trigger input
ONP	Nch-FET Open-Drain output with pull-up resistance
OC	C-MOS output
ON	Nch-FET Open-Drain output
R	Rise edge detection
F	Fall edge detection

[INPUT OUTPUT TERMINAL TYPE]

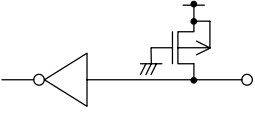
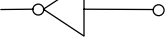
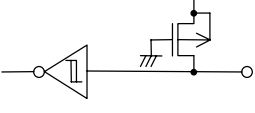
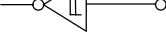
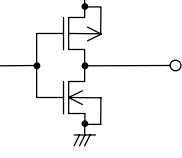
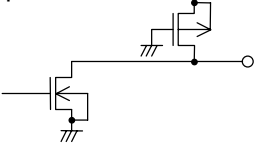
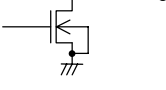
	Types	With Pull-up	Without Pull-up	Terminals	
INPUT TERMINAL	C-MOS	Type ICP 	Type IC 	PA0~PA3, PB0~PB3, PC0, PC1, PD0~PD3	
	SCHMITT TRIGGER	Type ISP 	Type IS 	PE0, PE1	
OUTPUT TERMINAL	C-MOS	/		Type ON 	PA0~PA3, PB0~PB3, PC0, PC1, PE0, PE1
	N-channel(Nch) OPEN DRAIN	Type ONP 	Type ON 	PD0~PD3	

2) Edge Detector Selection

PC1 terminal is added the "Edge detect function" by the mask option.



MEMO

[CAUTION]

The specifications on this databook are only given for information, without any guarantee as regards either mistakes or omissions. The application circuits in this databook are described only to show representative usages of the product and not intended for the guarantee or permission of any right including the industrial rights.