

3-INPUT/2-INPUT VIDEO SWITCH

■ GENERAL DESCRIPTION

The NJM2508 is video switch for video and audio signal. It contains 3 input-1 output and 2 input-1 output video switch. One input terminal has clamp function and so is applied to fixed DC level of video signal. Its operating voltage is 4.75 to 13V and bandwidth is 10MHz. Crosstalk is 75dB (at f=4.43MHz).

■ FEATURES

- Operating Voltage (+4.75V ~ +13V)
- 3 Input-1 Output and 2 Input-1 Output
- Crosstalk 75dB(at 4.43MHz)
- Wide Frequency Range 10MHz(2V_{pp} Input)
- Package Outline DIP16, DMP16, SSOP16
- Bipolar Technology

■ RECOMMENDED OPERATING CONDITION

- Operating Voltage V⁺ 4.75~13.0V

■ APPLICATION

- VTR, Video Camera, AV-TV, Video Disk Player.

■ BLOCK DIAGRAM

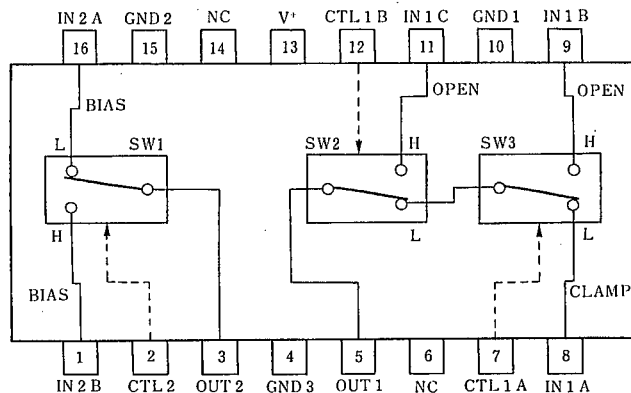

NJM2508D
NJM2508M
NJM2508V

■ PACKAGE OUTLINE

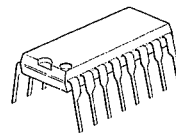

NJM2508D

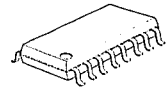

NJM2508M



NJM2508V

■ ABSOLUTE MAXIMUM RATINGS

(Ta=25°C)

PARAMETER	SYMBOL	RATINGS	UNIT
Supply Voltage	V*	14	V
Power Dissipation	Pd	(DIP16) 700	mW
		(DMP16) 350	mW
		(SSOP16) 300	mW
Operating Temperature Range	T _{opr}	-40~+85	°C
Storage Temperature Range	T _{stg}	-40~+125	°C

■ ELECTRICAL CHARACTERISTICS

(V*=5V, Ta=25°C)

PARAMETER	SYMBOL	TEST CONDITION	MIN.	TYP.	MAX.	UNIT
Operating Current 1	I _{CC1}	V*=5V (Note1)	6.6	9.4	12.3	mA
Operating Current 2	I _{CC2}	V*=9V (Note1)	8.0	11.5	15.0	mA
Voltage Gain	G _v	V _i = 2V _{P-P} /100kHz, V _O /V _i	-0.6	-0.1	+0.4	dB
Frequency Response	G _f	V _i = 2V _{P-P} , V _O (10MHz/100MHz)	-1.0	0	+1.0	dB
Differential Gain	DG	V _i = 2V _{P-P} Staircase Signal	—	0.3	—	%
Differential Phase	DP	V _i = 2V _{P-P} Staircase Signal	—	0.3	—	deg
Output Offset Voltage	V _{OS}	(Note2)	-10	0	+10	mV
Crosstalk	CT	V _i = 2V _{P-P} , 4.43MHz, V _O /V _i	—	-75	—	dB
Switch Change Voltage	V _{CH}	All inside SW: ON	2.5	—	—	V
Switch Change Voltage	V _{CL}	All inside SW: OFF	—	—	1.0	V

(Note1) S1=S2=S3=S4=S5=S6=S7=1

(Note2) Output DC Voltage Difference is tested on S6=1→2, S1=S2=S3=S4=S5=1, S8=2 and S7=1

■ TEST CIRCUIT

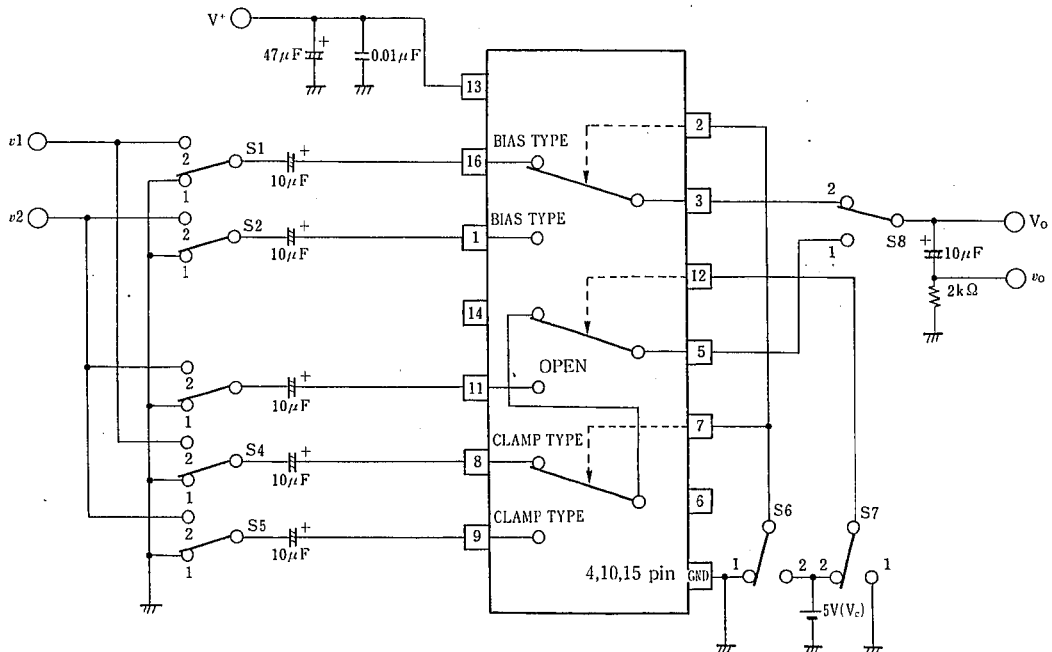

This IC requires 1MΩ resistance between INPUT and GND pin for clamp type input since the minute current causes an unstable pin voltage.

■ PIN FUNCTION

PIN NO.	PIN NAME	DC VOLTAGE	INSIDE EQUIVALENT CIRCUIT
16 1	IN 2 A IN 2 B (Input)	2.5V	
8	IN 1 A (Input)	1.5V	
9 11	IN 1 B IN 1 C (Input)		
7 12 2	CTL 1 A CTL 1 B CTL 2 (Control)		
5	OUT 1 (Output)	1.8V	
3	OUT 2 (Output)	0.8V	
13	V+	5 V	
15 4 10	GND 1 GND 2 GND 3		

5

■ TYPICAL CHARACTERISTICS ($T_a = +25^\circ\text{C}$)

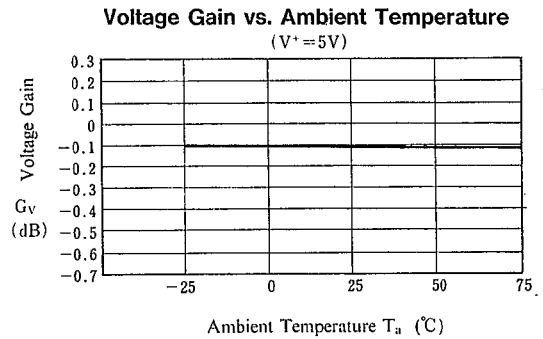
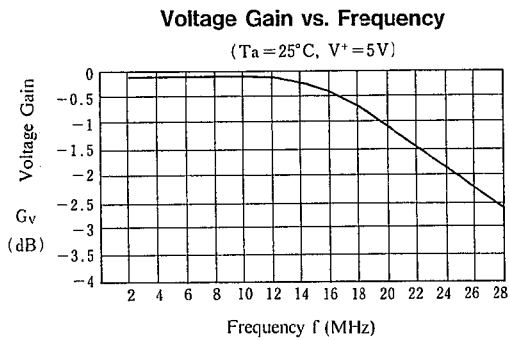
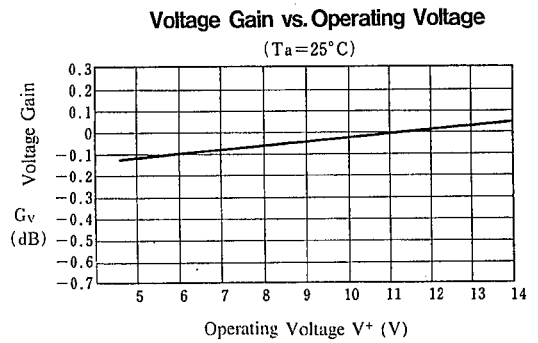
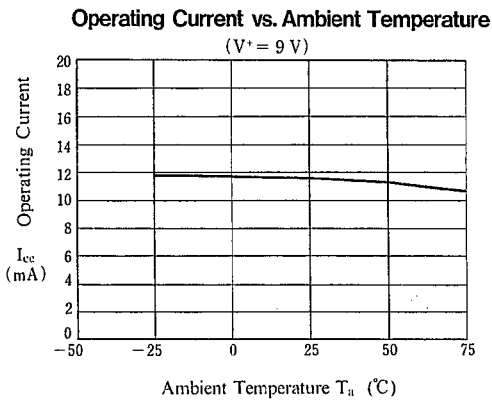
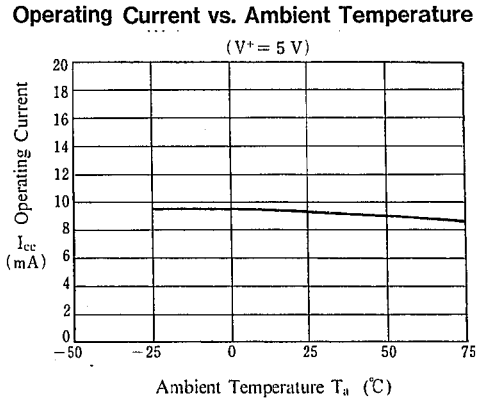
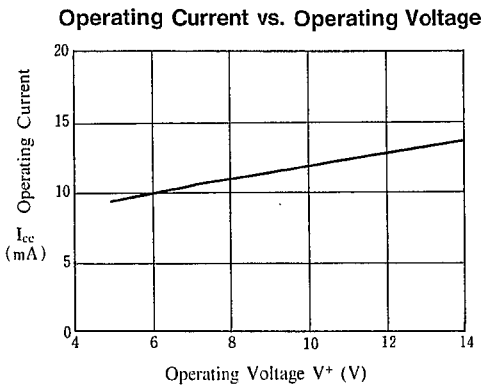

5

TYPICAL CHARACTERISTICS (T_a=+25°C)

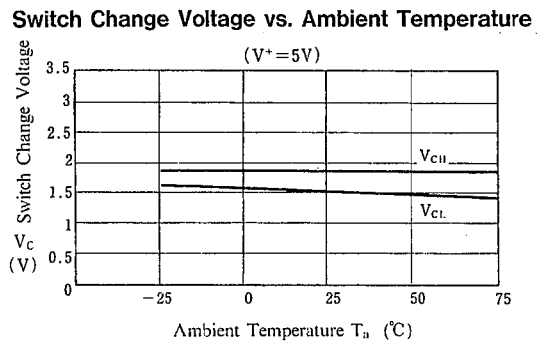
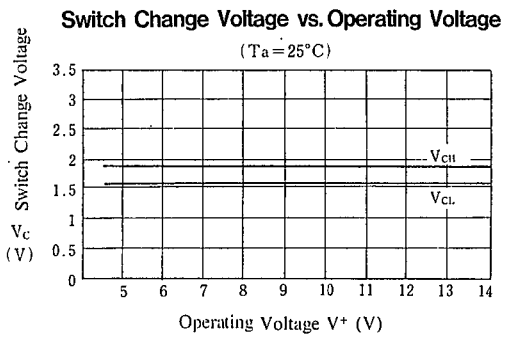
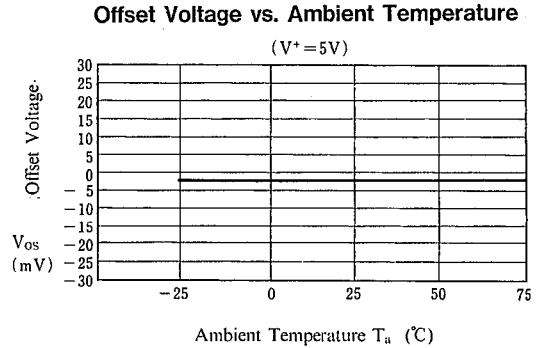
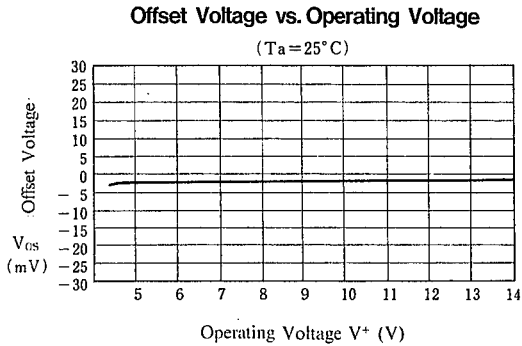
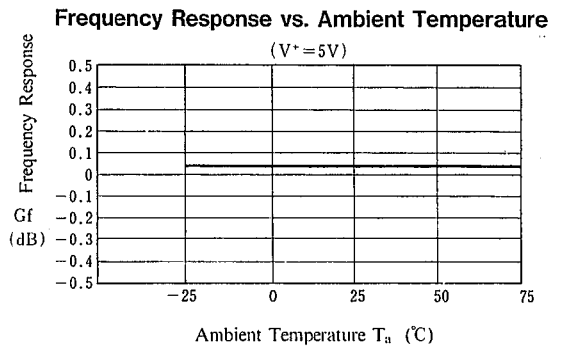
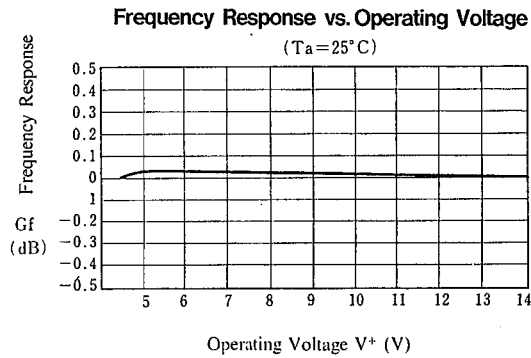

■ TYPICAL CHARACTERISTICS (Ta=+25°C)

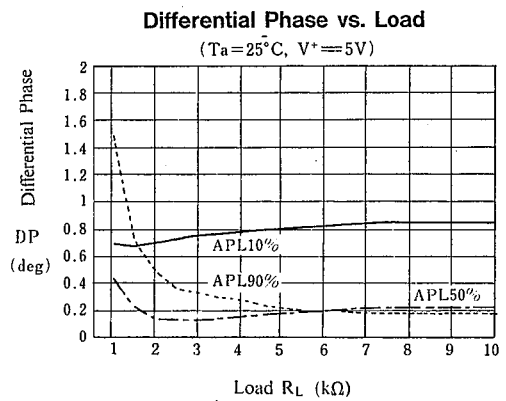
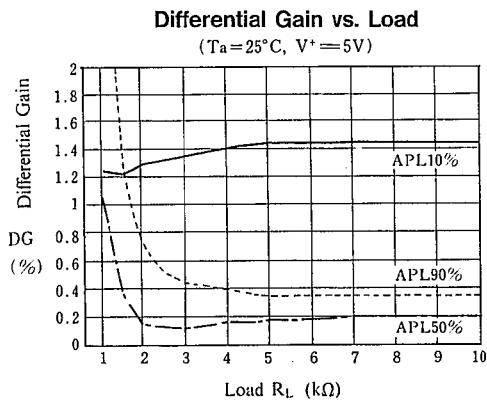
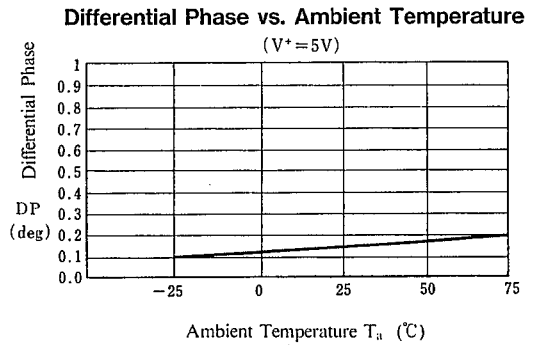
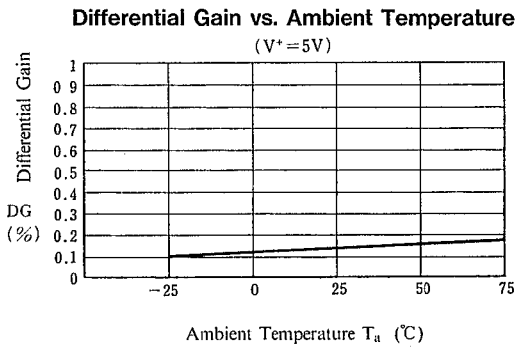
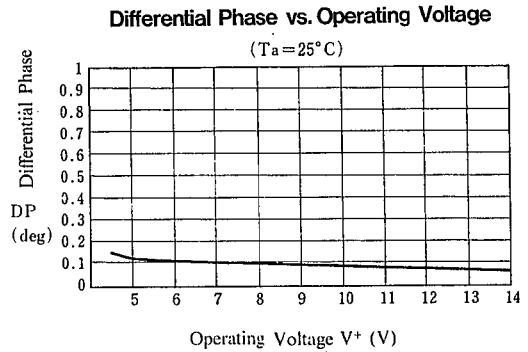
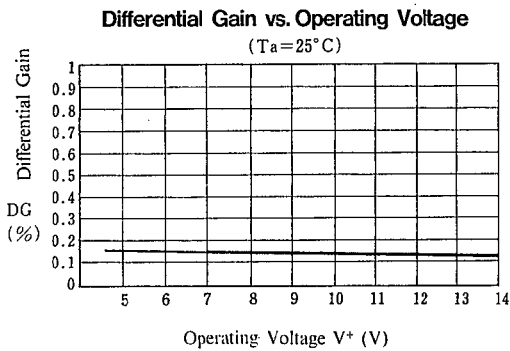

■ TYPICAL CHARACTERISTICS ($T_a = +25^\circ\text{C}$)

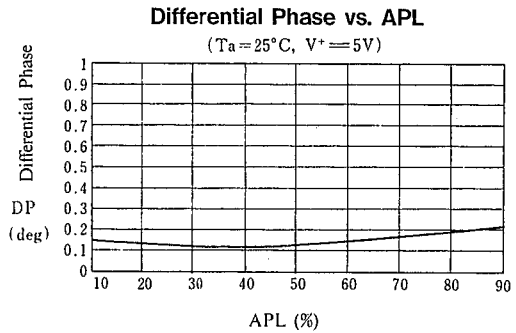
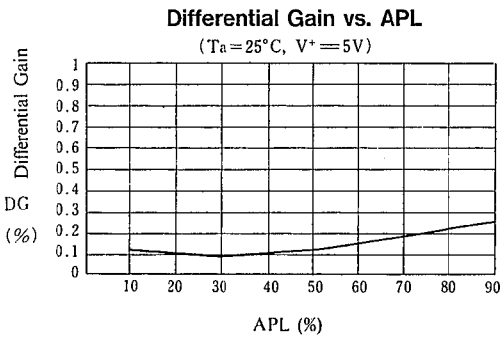
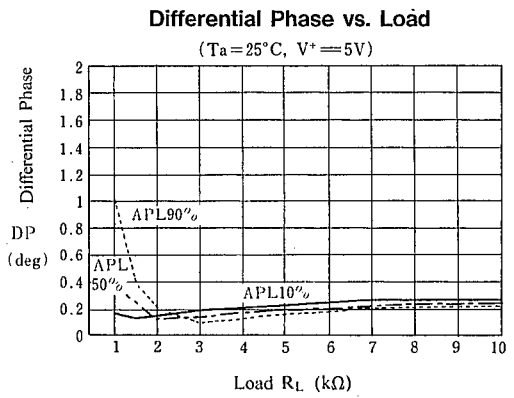
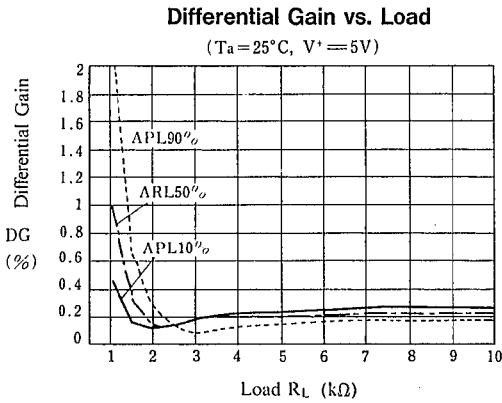
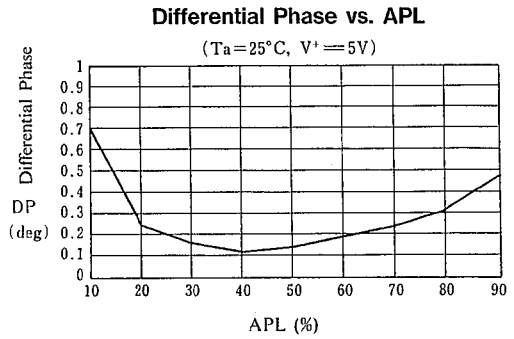
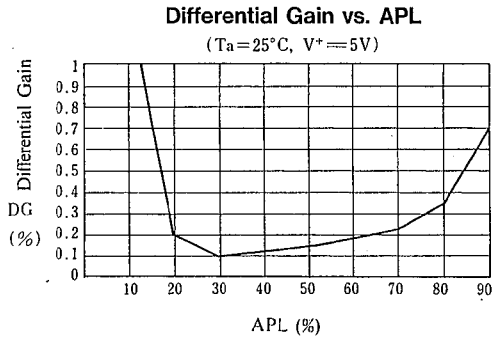

■ TYPICAL CHARACTERISTICS (Ta=+25°C)

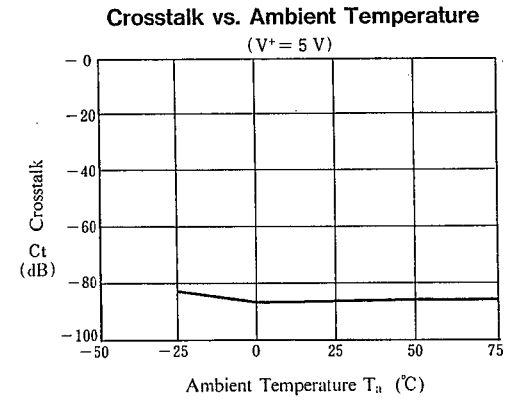
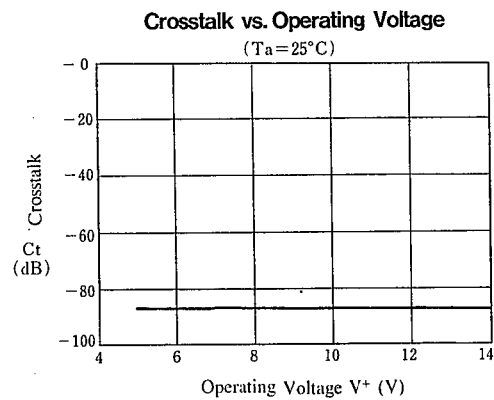
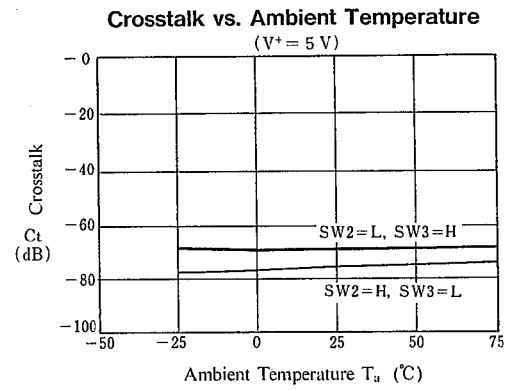
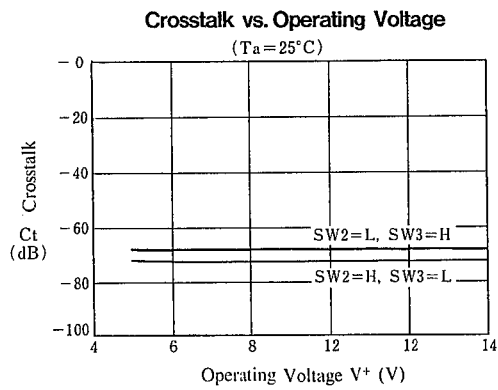
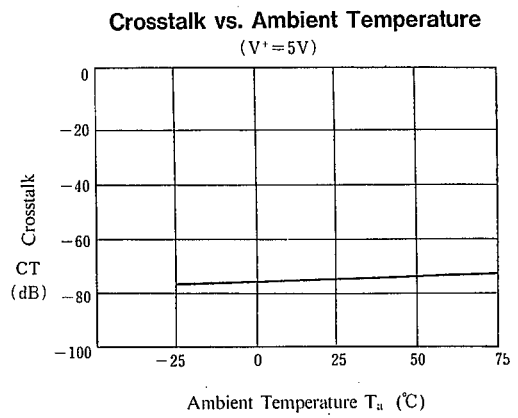
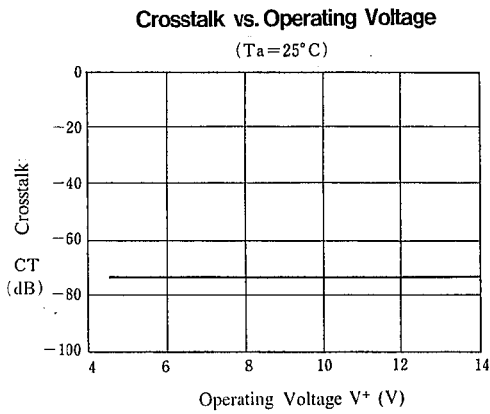

■ TYPICAL CHARACTERISTICS (Ta=+25°C)

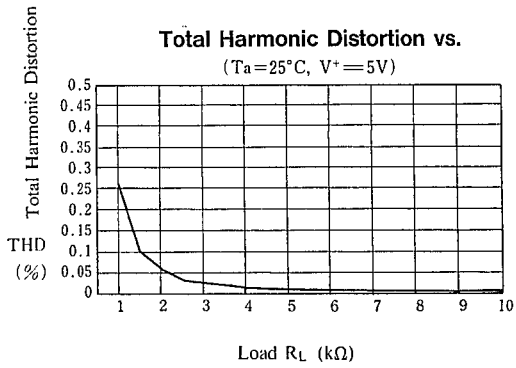

5

MEMO

[CAUTION]

The specifications on this databook are only given for information, without any guarantee as regards either mistakes or omissions. The application circuits in this databook are described only to show representative usages of the product and not intended for the guarantee or permission of any right including the industrial rights.