

## 3-INPUT 2-OUTPUT VIDEO SWITCH FOR AV-SET

### ■ GENERAL DESCRIPTION

**NJM2279** is 3-input, 2-output video switch with 75Ω, driver circuit.

This video switch can be connected to TV monitor directly, as it has 6dB amplifier and 75Ω drivers circuit internally.

The **NJM2279** has the mute function.

### ■ FEATURES

- 3 input 2 output
- Internal 6dB AMP.
- Internal 75Ω Driver Circuit
- Operating Voltage Dual ( $\pm 4V$  to Single (+8V to
- Internal 2 Output Mute Function
- Package Outline DIP14, DMP14
- Bipolar Technology

### ■ RECOMMENDED OPERATING CONDITION

- Supply Voltage Dual  $\pm 4.0V$  to  $\pm 7.0V$
- Supply Voltage Single +8V to +14V

### ■ BLOCK DIAGRAM

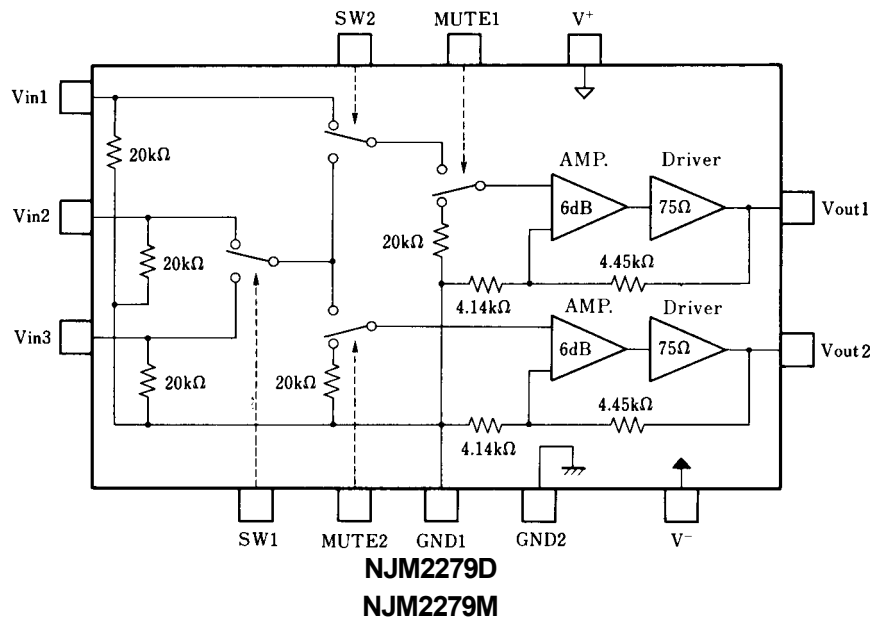

### ■ PIN CONFIGURATION

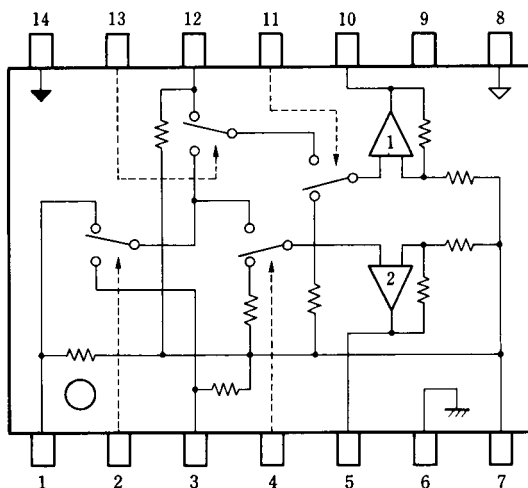

#### PIN FUNCTION

- |          |                    |
|----------|--------------------|
| 1. Vin3  | 8. V <sup>+</sup>  |
| 2. SW1   | 9. N.C.            |
| 3. Vin2  | 10. Vout1          |
| 4. MUTE2 | 11. MUTE1          |
| 5. Vout2 | 12. Vin1           |
| 6. GND2  | 13. SW2            |
| 7. GND1  | 14. V <sup>-</sup> |

# NJM2279

## ■ ABSOLUTE MAXIMUM RATINGS

( $T_a = 25^\circ\text{C}$ )

PARAMETER	SYMBOL	RATINGS	UNIT
Supply Voltage	$V^+ / V^-$	$\pm 7.5$	V
Power Dissipation	$P_D$	(DIP14) 700 (DMP14) 300	mW mW
Operating Temperature Range	$T_{opr}$	-20 to +75	$^\circ\text{C}$
Storage Temperature Range	$T_{stg}$	-40 to +125	$^\circ\text{C}$

## ■ ELECTRICAL CHARACTERISTICS

( $V^+ / V^- = \pm 5\text{V}$ ,  $R_L = 150\Omega$ ,  $T_a = 25^\circ\text{C}$ )

PARAMETER	SYMBOL	TEST CONDITION	MIN.	TYP.	MAX.	UNIT
Operating Current	$I_{CC}$	No signal	10.0	17.3	24.6	mA
	$I_{EE}$	No signal	-24.6	-17.3	-10.0	mA
Voltage Gain	$G_V$	$V_{IN} = 100\text{kHz} / 1.0V_{P-P}$	6.0	6.3	6.8	dB
Frequency Characteristic	$G_f$	5MHz / 100kHz, $1.0V_{P-P}$	-1.0	0.0	+1.0	dB
Differential Gain	DG	$V_{IN} = 1.0V_{P-P}$ , Stair wave	-	0.2	-	%
Differential Phase	DP	$V_{IN} = 1.0V_{P-P}$ , Stair wave	-	0.2	-	deg
Offset output Voltage 1	$V_{OS1}$	$V_{in2} - V_{in3}$ : no signal	-40	0	+40	mV
Offset output Voltage 2	$V_{OS2}$	$V_{in1} - V_{in2} / V_{in3}$ : no signal	-60	0	+60	mV
Input / Output Crosstalk	CT	$V_{IN} = 4.43\text{MHz} / 1.0V_{P-P}$ , $V_O / V_{IN}$	-	-70	-	dB
MUTE Crosstalk	$CT_M$	$V_{IN} = 4.43\text{MHz} / 1.0V_{P-P}$ , $V_O / V_{IN}$	-	-60	-	dB
Switch Change Voltage	$V_{CH}$		2.5	-	$V^+$	V
	$V_{CL}$		0.0	-	1.0	V
Total Harmonic Distortion	THD	$V_{IN} = 1\text{kHz} 1.25V_{P-P}$	-	0.1	-	%
Input Impedance	$R_{in}$		-	20	-	k $\Omega$

## ■ TEST CIRCUIT

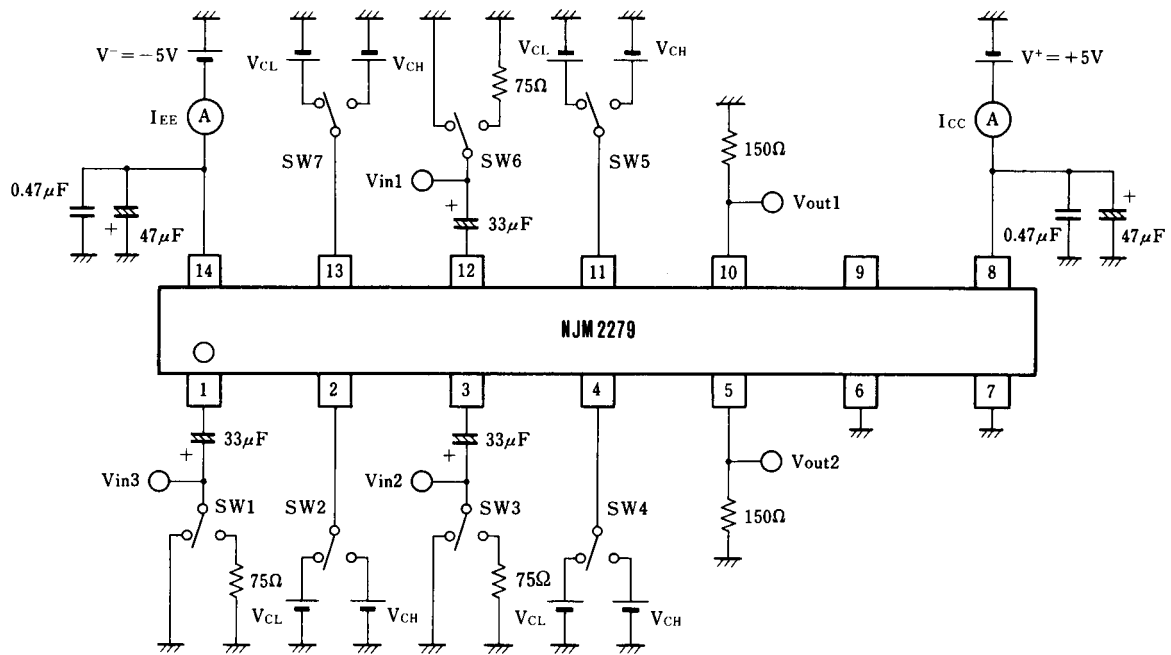

PARAMETER	SYMBOL	UNIT	INPUT TERMINAL	TEST TERMINAL	TEST CONDITION
Operating Current	$I_{CC}$	mA	-	8 pin	$V_{in1}$ to 3 = 0V, SW1/2·MUTE1/2 = $V_{CL}$
	$I_{EE}$	mA	-	14 pin	$V_{in1}$ to 3 = 0V, SW1/2·MUTE1/2 = $V_{CL}$
Voltage Gain	$G_V$	dB	1, 3, 12 pin	5, 10 pin	MUTE1/2 = $V_{CL}$
Frequency Characteristic	$G_f$	dB	1, 3, 12 pin	5, 10 pin	MUTE1/2 = $V_{CL}$
Differential Gain	DG	%	1, 3, 12 pin	5, 10 pin	MUTE1/2 = $V_{CL}$
Differential Phase	DP	deg	1, 3, 12 pin	5, 10 pin	MUTE1/2 = $V_{CL}$
Offset output Voltage 1	$V_{OS1}$	mV	1, 3, 12 pin	5, 10 pin	$V_{in1}$ to 3 = 0V
Offset output Voltage 2	$V_{OS2}$	mV	-	5, 10 pin	$V_{in1}$ to 3 = 0V
Input / Output Crosstalk	CT	dB	-	5, 10 pin	MUTE1/2 = $V_{CL}$
MUTE Crosstalk	$CT_M$	dB	1, 3, 12 pin	5, 10 pin	MUTE1/2 = $V_{CL}$
Switch Change Voltage	$V_{CH}$	V	1, 3, 12 pin	5, 10 pin	
	$V_{CL}$	V	-	-	
Total Harmonic Distortion	THD	%	1, 3, 12 pin	5, 10 pin	

# NJM2279

## CONTROL SIGNAL-OUTPUT SIGNAL

(L =  $V_{CL}$ , H =  $V_{CH}$ , X = LorH)

CONTROL SIGNAL				OUTPUT	
SW1 (2 pin)	SW2 (13 pin)	MUTE 1 (11 pin)	MUTE 2 (4 pin)	Vout 1 (10 pin)	Vout 2 (5 pin)
X	X	L	L	GND	GND
X	X	L	H	GND	OUT PUT
X	X	H	L	OUT PUT	GND
L	L	H	H	$V_{IN 1}$	$V_{IN 2}$
L	H	H	H	$V_{IN 2}$	$V_{IN 2}$
H	L	H	H	$V_{IN 1}$	$V_{IN 3}$
H	H	H	H	$V_{IN 3}$	$V_{IN 3}$

## APPLICATION

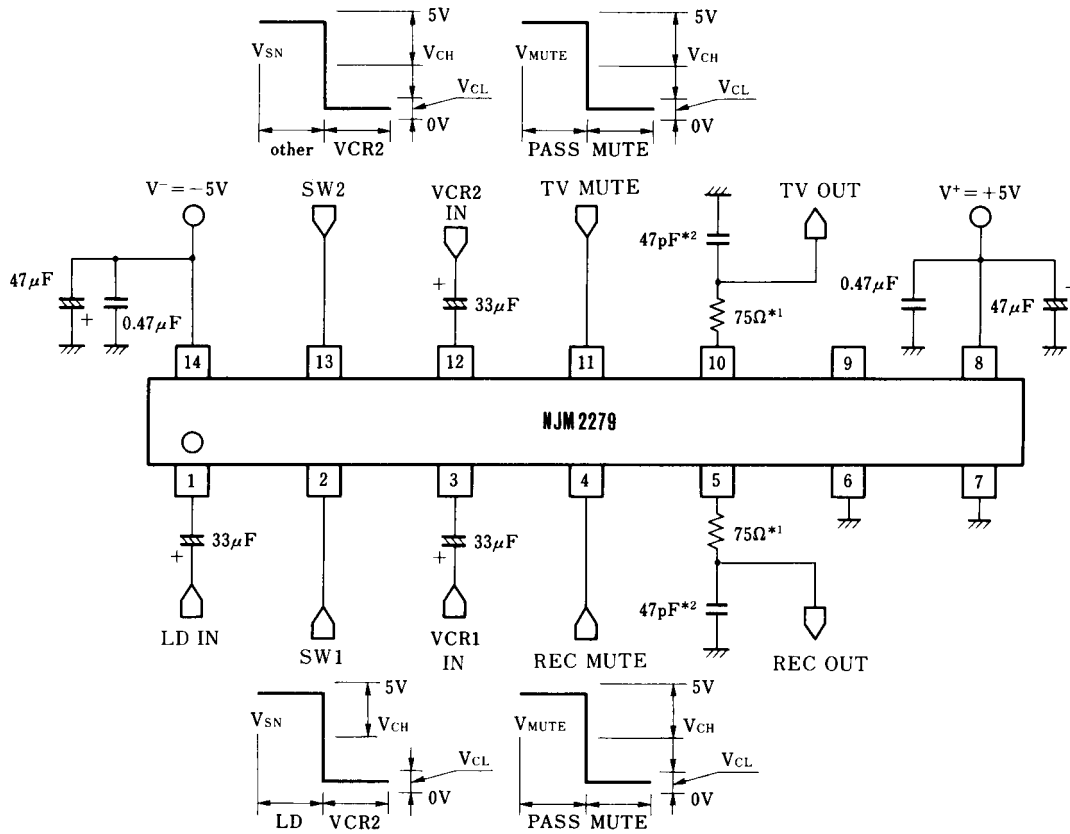

## ■ TYPICAL CHARACTERISTICS

### Operating Current vs. Temperature

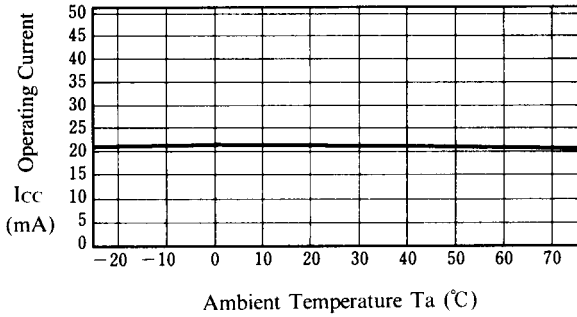

### Voltage Gain vs. Temperature

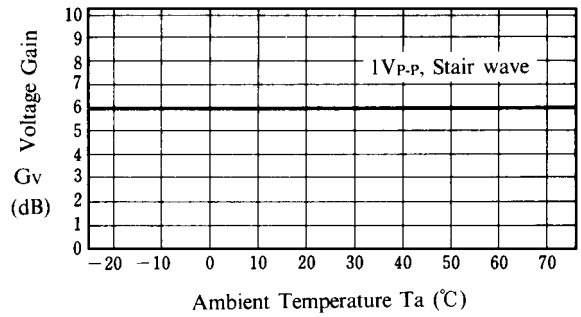

### Differential Gain vs. Temperature

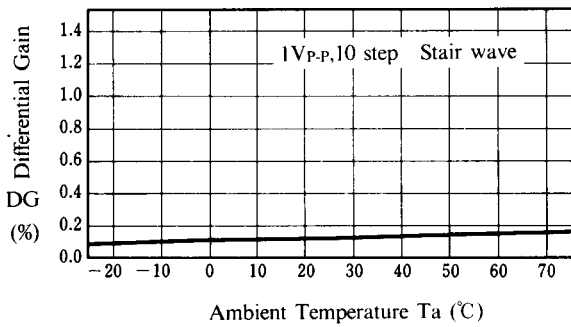

### Differential Phase vs. Temperature

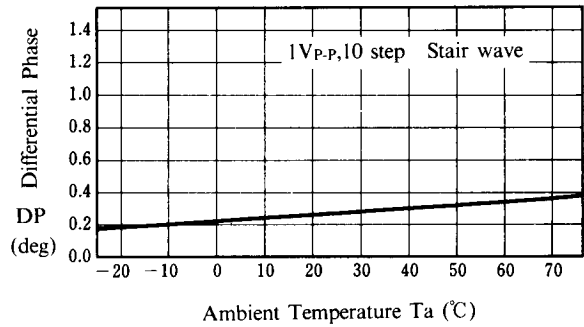

### Crosstalk 1 vs. Temperature

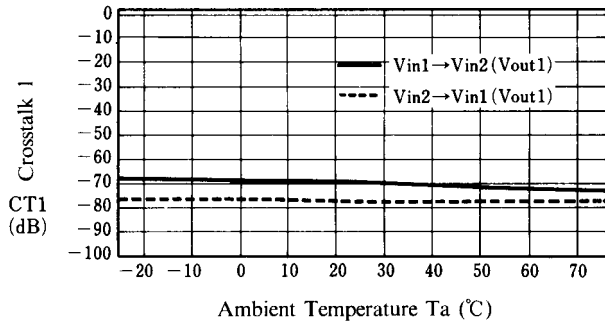

### Crosstalk 2 vs. Temperature

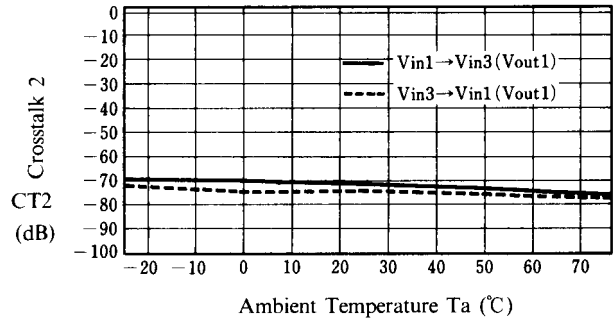

## ■ TYPICAL CHARACTERISTICS

### Crosstalk 3 vs. Temperature

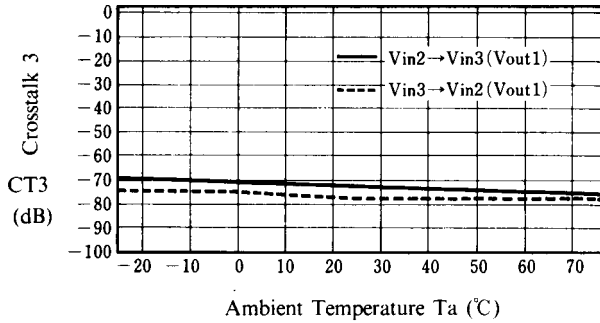

### Crosstalk 4 vs. Temperature

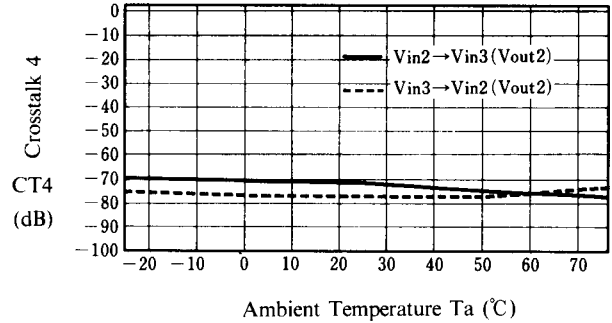

### MUTE Crosstalk vs. Temperature

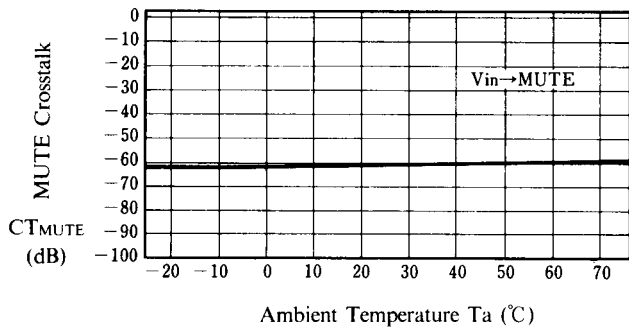

### MUTE offset Voltage vs. Temperature

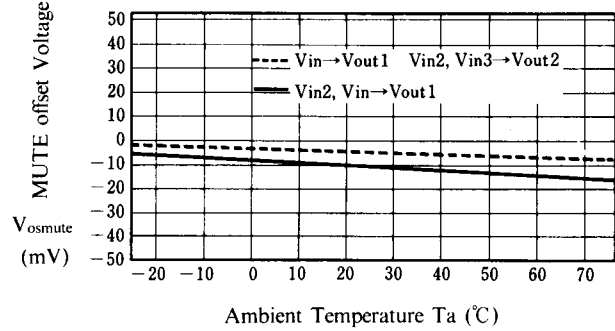

### Channel offset Voltage vs. Temperature

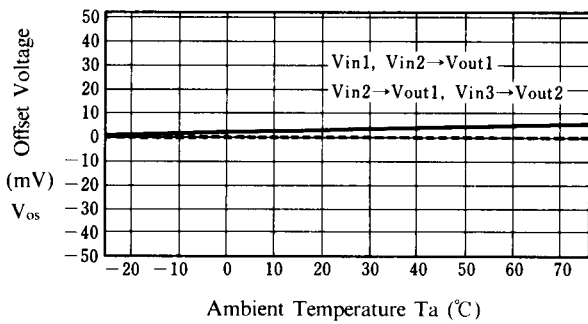

### Total Harmonic Distortion vs. Temperature

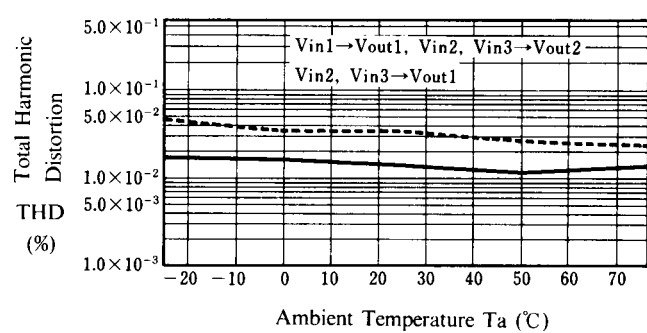

## ■ TYPICAL CHARACTERISTICS

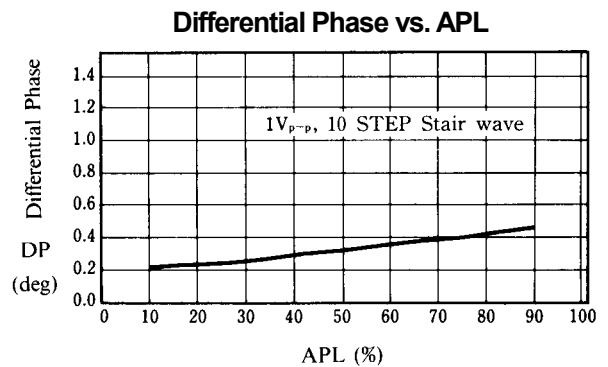
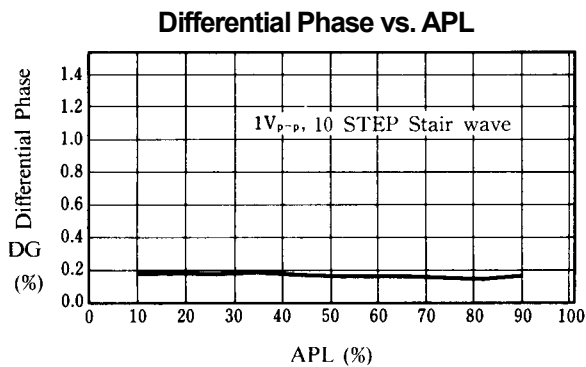
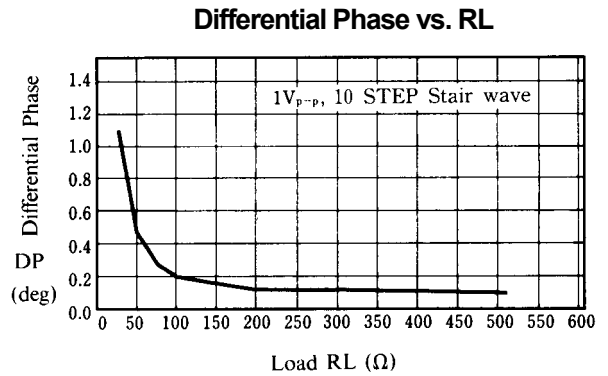
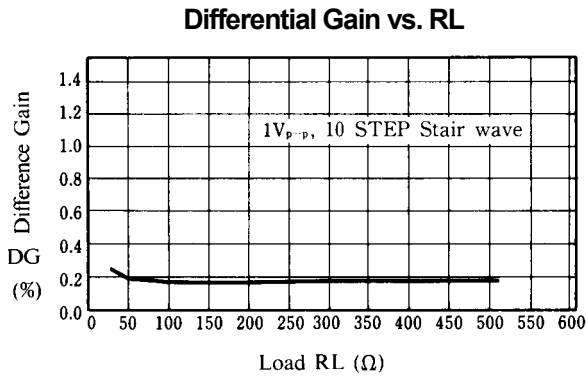
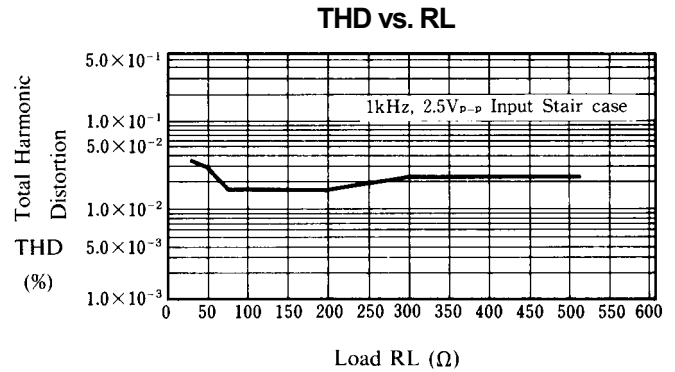
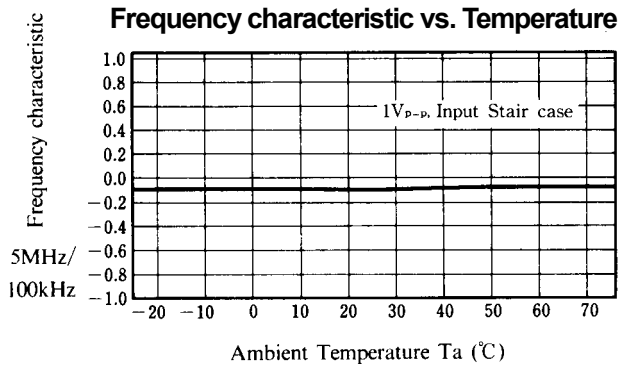

## ■ TYPICAL CHARACTERISTICS

**Operating Current vs. Operating Voltage**

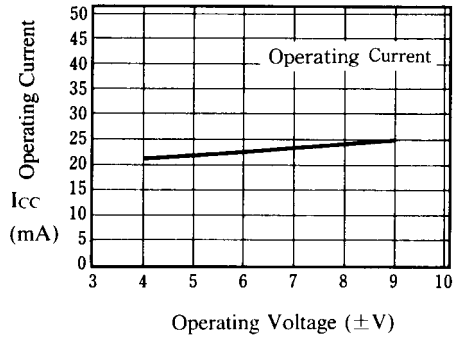

**THD vs. Operating Voltage**

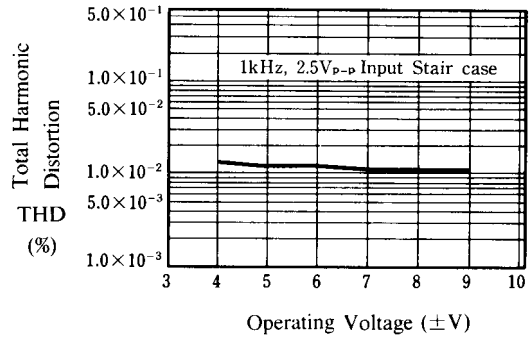

**Different Gain vs. Operating Voltage**

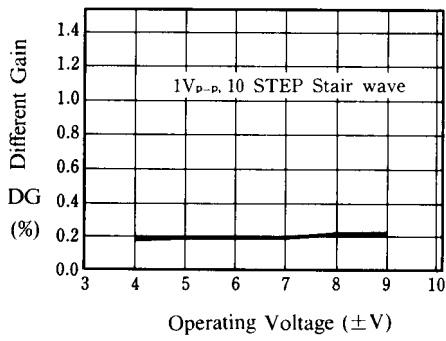

**Differential Phase vs. Operating Voltage**

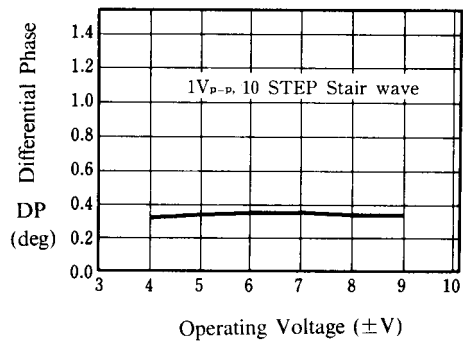

**Voltage Gain vs. Frequency**

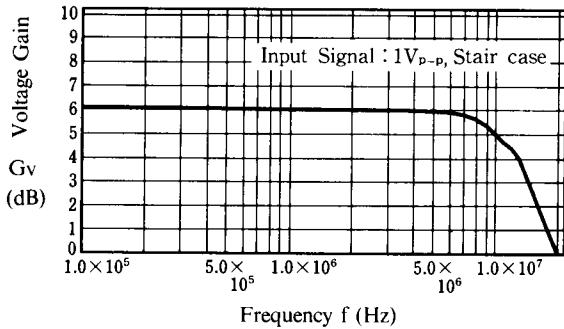

**Switching Voltage vs. Operating Voltage**

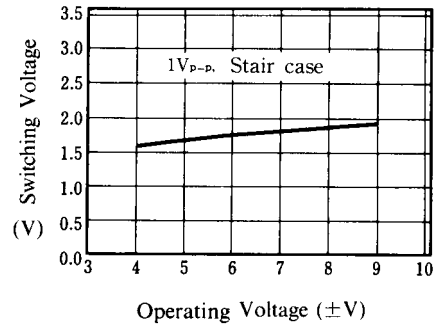



## ■ TYPICAL CHARACTERISTICS

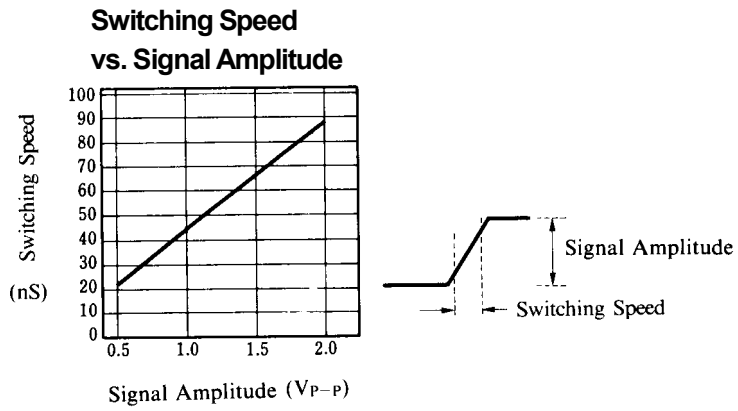

**[CAUTION]**

The specifications on this databook are only given for information, without any guarantee as regards either mistakes or omissions. The application circuits in this databook are described only to show representative usages of the product and not intended for the guarantee or permission of any right including the industrial rights.