

DUAL VIDEO 6dB AMPLIFIER WITH 75Ω DRIVER

■ GENERAL DESCRIPTION

NJM2268 is a dual video 6dB amplifier with 75 Ω drivers for S-VHS VCRs, HI-BAND VCRs, etc..One channel has clamp function that fixes DC level of video signal and another one is bias type. Furthermore it has 75 Ω drivers to be connected to TV monitors directly and sag corrective circuits that prevent the generation of sag with smaller capacitance than ever.

Its operating supply voltage is 4.85 to 9V and bandwidth is 7MHz.

■ FEATURES

- Wide Operating Voltage (4.85~9.0V)
- Dual Channel (Clamp Type, Bias Type)
- Internal Driver Circuit For 75 Ω Load
- SAG Corrective Function
- Wide Frequency Range 7MHz
- Low Operating Current 14.0mA (Dual)
- Package Outline DIP8, DMP8, SSOP8
- Bipolar Technology

■ RECOMMENDED OPERATING CONDITION

- Operating Voltage V^+ 4.85~9.0V

■ APPLICATIONS

- VCR, Video Camera, TV, Video Disc Player

■ BLOCK DIAGRAM

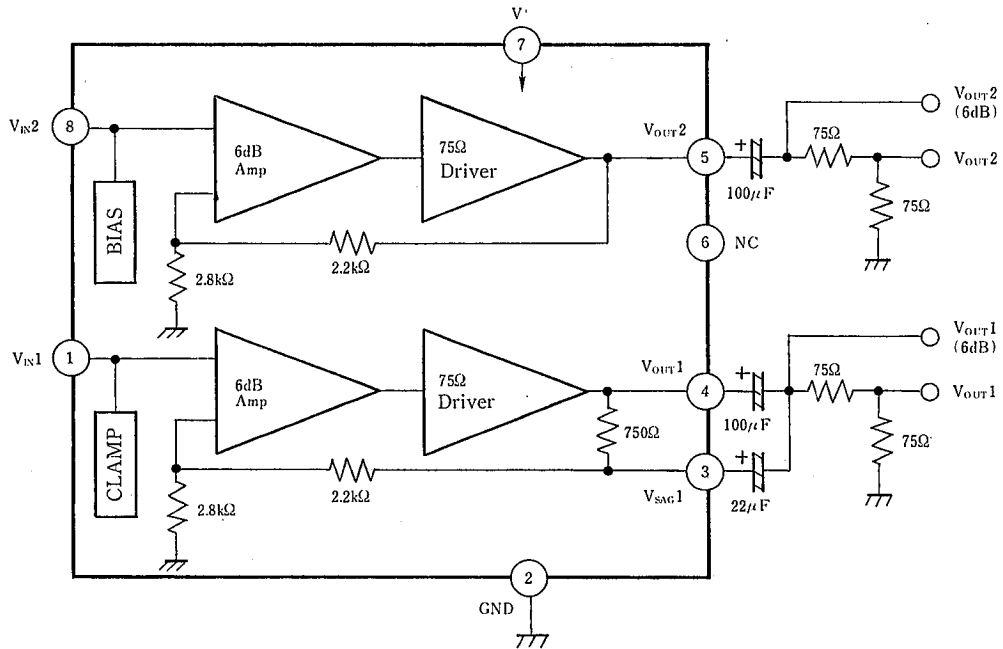

■ PACKAGE OUTLINE

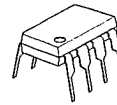

NJM2268D



NJM2268V

■ ABSOLUTE MAXIMUM RATINGS

(Ta=25°C)

PARAMETER	SYMBOL	RATINGS	UNIT
Supply Voltage	V*	10	V
Power Dissipation	Pd	(DIP8) 500	mW
		(DMP8) 300	mW
		(SSOP8) 250	mW
Operating Temperature Range	Topr	-40 ~ +85	°C
Storage Temperature Range	Tstg	-40 ~ +125	°C

■ ELECTRICAL CHARACTERISTICS:

(V+=5V, Ta=25°C)

PARAMETER	SYMBOL	TEST CONDITION	MIN.	TYP.	MAX.	UNIT
Operating Current	ICC	No Signal	—	14.0	18.2	mA
Voltage Gain	Gv	VIN=1MHz, 1Vp-p Sinewave	5.7	6.2	6.7	dB
Frequency Characteristic	Gf	VIN=1Vp-p, Sinewave, 7MHz/1MHz	—	—	±1.0	dB
Differential Gain *	DG	VIN=1Vp-p, Staircase	—	1.0	3.0	%
Differential Phase *	DP	VIN=1Vp-p, Staircase	—	1.0	3.0	deg
Crosstalk	CT	VIN=4.43MHz, 1Vp-p, Sinewave	—	-70	—	dB
Gain Offset	GCH	VIN=1MHz, 1Vp-p, GCH=VOUT1-VOUT2	—	—	±0.5	dB
Input Clamp Voltage	VCL		1.79	1.91	2.03	V
Input Bias Voltage	VBI		2.56	2.84	3.12	V
SAG Terminal Gain	GSAG		35	45	—	dB

NOTE: "*" is applied to clamp type input side only/

5

■ APPLICATION

Oscillation Prevention

It is much effective to insert LPE (Cutoff Frequency 70MHz) under light loading conditions ($R_L \gg 1k\Omega$).

This IC requires $1M\Omega$ resistance between INPUT and GND pin for clamp type input since the minute current causes an unstable pin voltage.

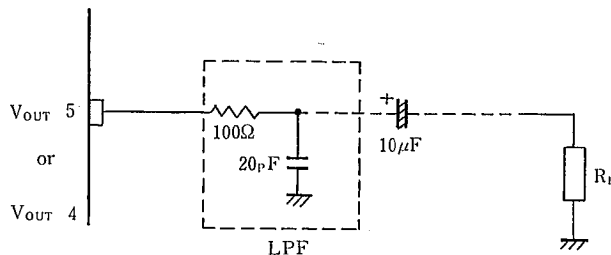

■ TEST CIRCUIT

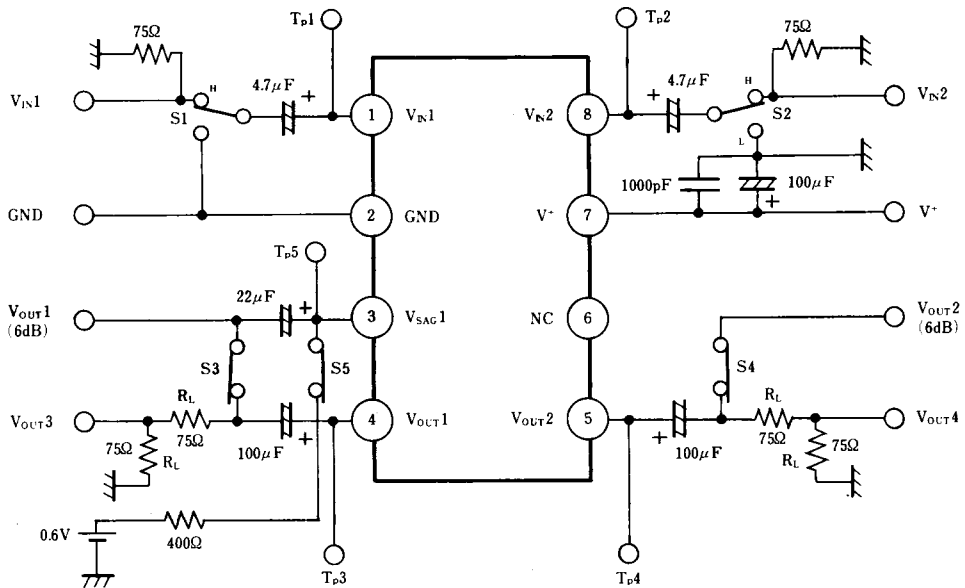

■ TEST METHODES

PARAMETER	SYMBOL	SWITCH CONDITIONS						CONDITIONS
		S1	S2	S3	S4	S5	S6	
Supply Current	I_{CC}	H	H					7PIN Sink Current
Voltage Gain	G_V	H	H	ON	ON			V_{OUT1}/V_{IN1} , V_{OUT2}/V_{IN2} at $V_{IN1}(V_{IN2})=1\text{MHz}$, $1V_{P-P}$, Sinewave
Frequency Characteristic	G_f	H	H	ON	ON			G_{V1M} ; Voltage Gain at $V_{IN1}(V_{IN2})=1\text{MHz}$, $1V_{P-P}$ G_{V10M} ; Voltage Gain at $V_{IN1}(V_{IN2})=10\text{MHz}$, $1V_{P-P}$ $G_f = G_{V10M} - G_{V1M}$
Differential Gain	DG	H	H	ON	ON			Measuring V_{OUT3} at $V_{IN1}=\text{Staircase Signal}$
Differential Phase	DP	H	H	ON	ON			Measuring V_{OUT3} at $V_{IN1}=\text{Staircase Signal}$
Crosstalk	CT	H	L	ON	ON			V_{OUT2}/V_{OUT1} at $V_{IN1}=4.43\text{MHz}$, $1V_{P-P}$, Sinewave V_{OUT1}/V_{IN2} at $V_{IN2}=4.43\text{MHz}$, $1V_{P-P}$, Sinewave
Gain Offset	G_{CH}	H	H	ON	ON			$G_{V1}=V_{OUT1}/V_{IN1}$, $G_{V2}=V_{OUT2}/V_{IN2}$ $G_{CH}=G_{V1}-G_{V2}$
Input Clamp Voltage	V_{CL}	H	H					Measuring at TP1
Input Bias Voltage	V_{Br}	H	H					Measuring at TP2
SAG Terminal Gain	G_{SAG}	H	H			ON	ON	TP3 Voltage; V_{O1A} , TP5 Voltage; V_{S01A} TP3 Voltage; V_{O1B} , TP5 Voltage; V_{S01B} $G_{SAG}=20\log \left\{ (V_{O1B}-V_{O1A}) / (V_{S01A}-V_{S01B}) \right\}$

(V⁺=5.0V, T_a=25°C)

■ TERMINAL FUNCTION:

PIN No.	PIN NAME	SYMBOL	EQUIVALENT CIRCUIT	FUNCTIONS
1	Input Clamp Terminal	V _{IN1}		Input terminal of 1V _{P-P} composite Signal or Y signal Clamp level is 1.9V
2	GND	GND		Ground
3	SAG correction	V _{SAG1}		SAG caused by a coupling capacitor of the output can be prevented by connecting this terminal with the output terminal through an external capacitor. (see block diagram) When SAG correcting function is not necessary, this terminal must be connected with pin "4" directly.
4	Video Output1	V _{OUT1}		Output terminal (clamp side) that can drive 75Ω line.
5	Video Output2	V _{OUT2}		Output terminal (bias side) that can drive 75Ω line.
6	No Connection	NC		
7	V ⁺	V ⁺		Supply Voltage
8	Input Clamp Terminal	V _{IN2}		Input terminal of 1V _{P-P} color signal. Bias level is 2.8V.

■ TYPICAL CHARACTERISTICS

Operating Current vs. Ta
(V⁺=5 V)

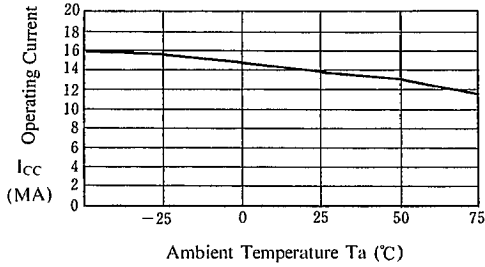

Input DC Level vs. Ta
(V⁺=5 V)

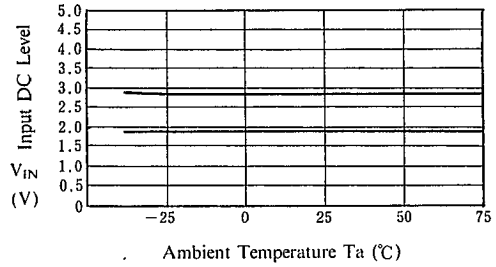

Output DC Level vs. Ta
(V⁺=5 V)

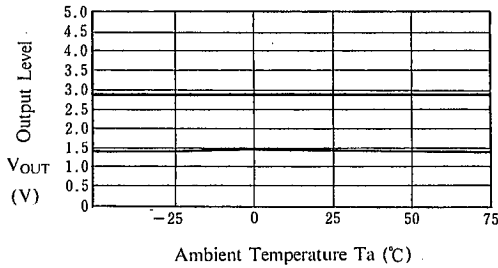

SAG Terminal Voltage vs. Ta
(V⁺=5V)

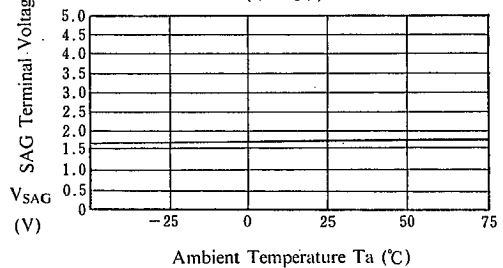

SAG Terminal Gain vs. Ta
(V⁺=5 V)

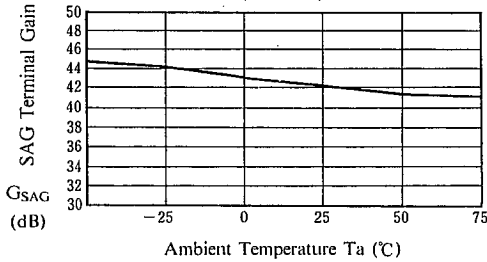

Voltage Gain vs. Ta(Clamp Type Input)
(V⁺=5V, 1V_{p-p}, 1MHz, staircase signal input)

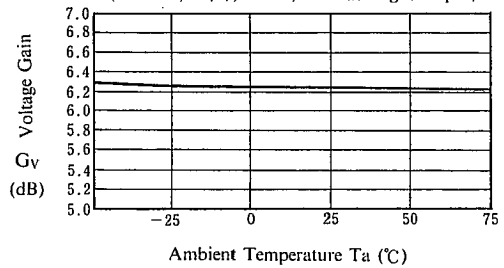

5

■ TYPICAL CHARACTERISTICS

Voltage Gain vs. Ta (Bias Type Input)
($V^+ = 5V$, $1V_{p-p}$, sinewave signal input)

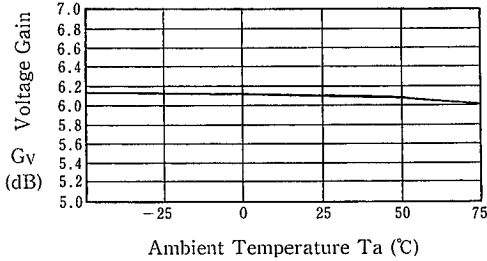

Gain Frequency Characteristics vs. Ta (Clamp Type Input)
($V^+ = 5V$, $1V_{p-p}$, 7MHz/1MHz)

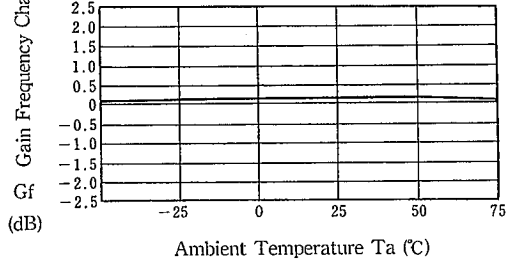

Gain Frequency Characteristics vs. Ta (Bias Type Input)
($V^+ = 5V$, $1V_{p-p}$, 7MHz/1MHz)

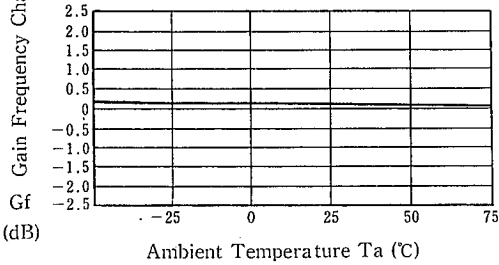

Differential Gain vs. Ta
($V^+ = 5V$, $1V_{p-p}$ staircase signal input)

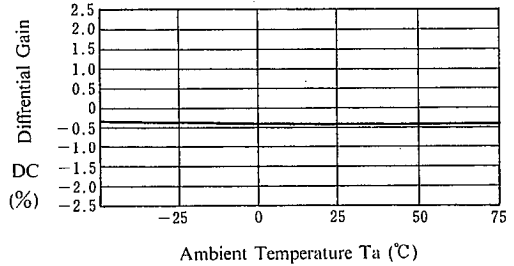

Differential Phase vs. Ta
($V^+ = 5V$, $1V_{p-p}$ staircase signal input)

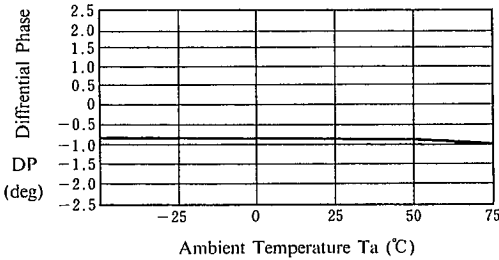

Operating Current vs. Operating Voltage
($T_a = 25^\circ C$)

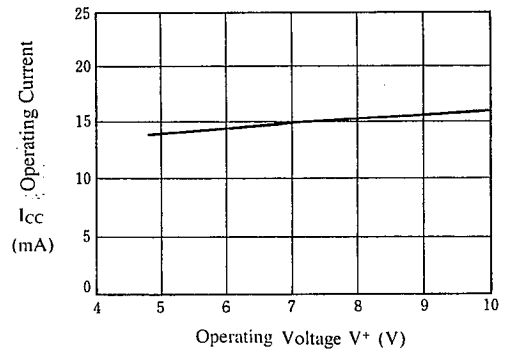

■ TYPICAL CHARACTERISTICS

Input DC Level vs. Operating Voltage
($T_a = 25^\circ\text{C}$)

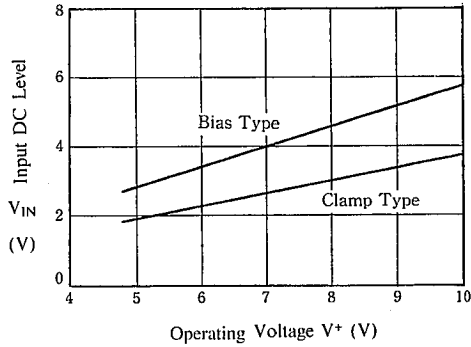

Output DC Level vs. Operating Voltage
($T_a = 25^\circ\text{C}$)

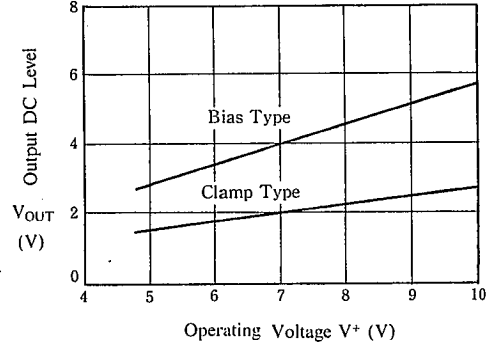

SAG Terminal Voltage vs. Operating Voltage
($T_a = 25^\circ\text{C}$)

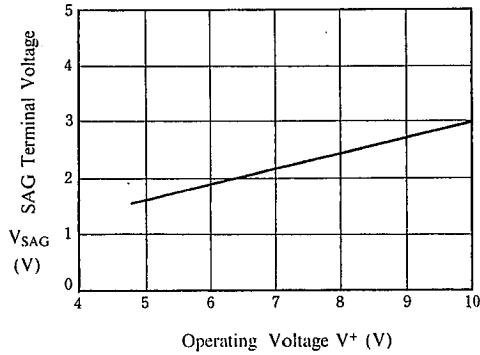

SAG Terminal Gain vs. Operating Voltage
($T_a = 25^\circ\text{C}$)

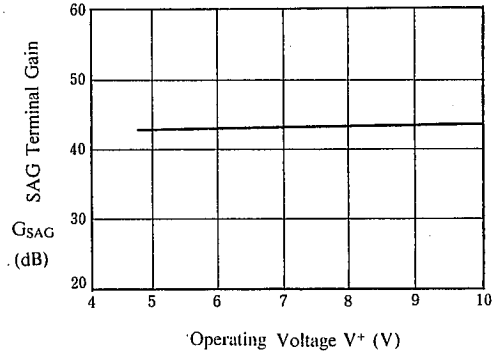

Voltage Gain vs. Operating Voltage
(Clamp Type Input)

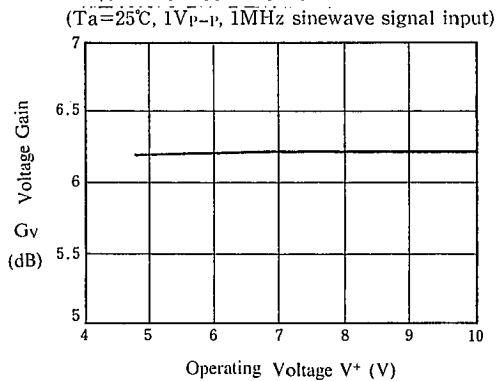

Voltage Gain vs. Operating Voltage
(Bias Type Input)

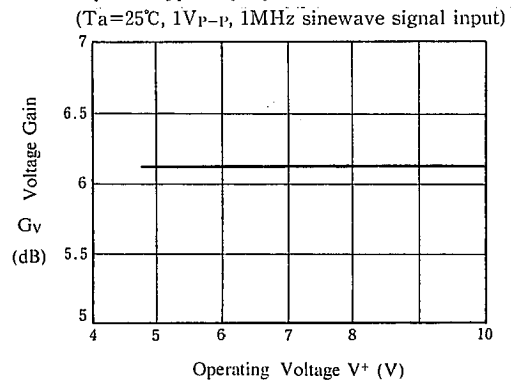

TYPICAL CHARACTERISTICS

Gain Frequency Characteristics vs. Operating Voltage (Clamp Type Input)
 (Ta=25°C, 1V_{p-p}, 7MHz/1MHz)

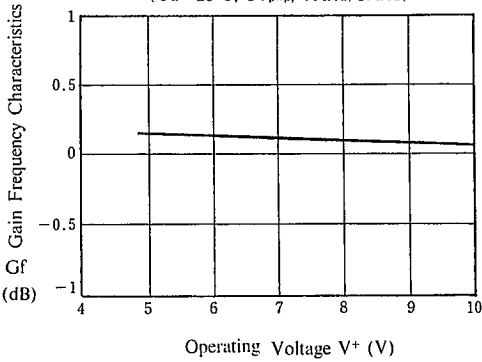

Gain Frequency Characteristics vs. Operating Voltage (Bias Type Input)
 (Ta=25°C, 1V_{p-p}, 7MHz/1MHz)

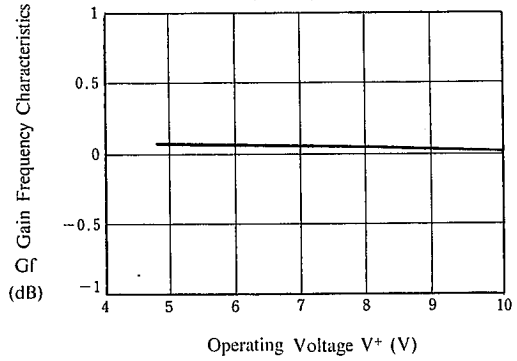

Differential Gain vs. Operating Voltage
 (Ta=25°C, 1V_{p-p}, staircase signal input)

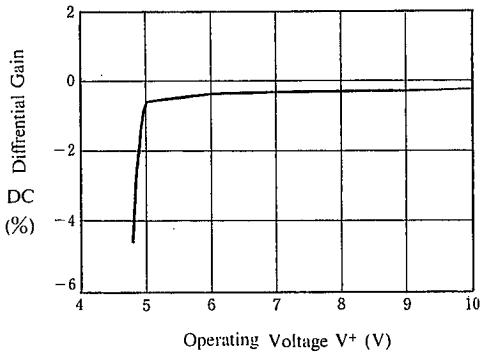

Differential Phase vs. Operating Voltage
 (Ta=25°C, 1V_{p-p}, staircase signal input)

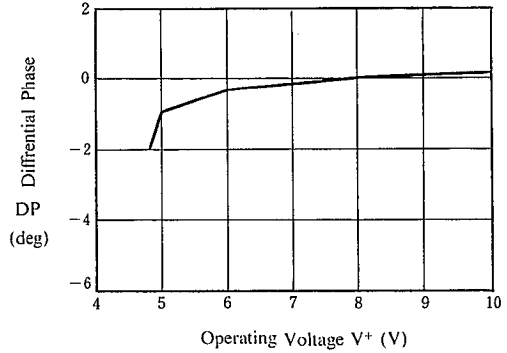

Voltage Gain vs. Frequency (Clamp Type Input)
 (Ta=25°C, V+=5V, 1V_{p-p} sinewave signal input)

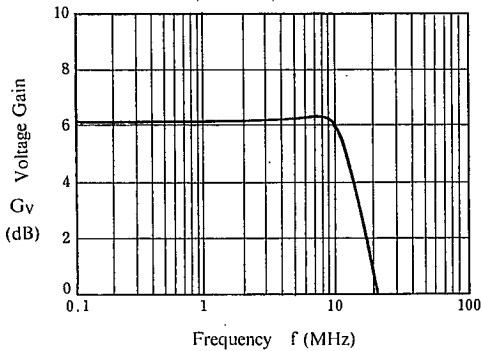

Voltage Gain vs. Frequency (Bias Type Input)
 (Ta=25°C, V+=5V, 1V_{p-p} sinewave signal input)

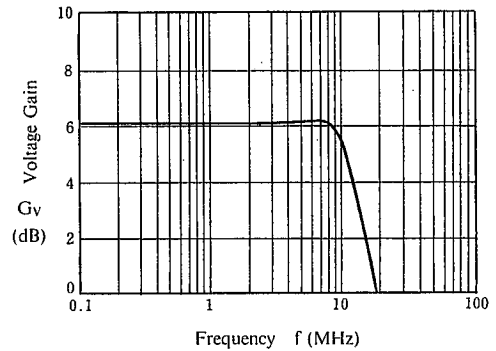

■ TYPICAL CHARACTERISTICS

Small Signal Voltage Gain vs. Frequency (Clamp Type Input)

($T_a=25^\circ\text{C}$, $V^+=5\text{V}_{\text{P-P}}$, $25\text{mV}_{\text{P-P}}$ sinewave signal input)

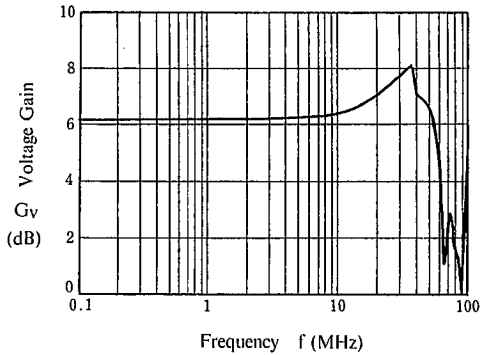

Small Signal Voltage Gain vs. Frequency (Bias Type Input)

($T_a=25^\circ\text{C}$, $V^+=5\text{V}$, $25\text{mV}_{\text{P-P}}$, sinewave signal input)

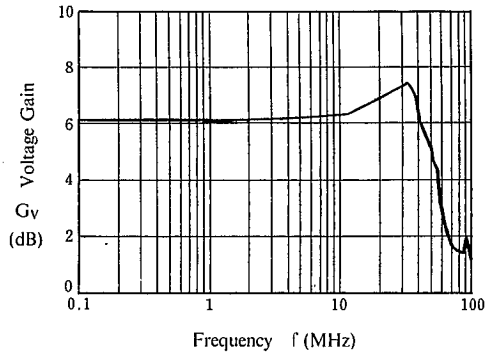

Cross Talk vs. Frequency

($T_a=25^\circ\text{C}$, $V^+=5\text{V}$, $1\text{V}_{\text{P-P}}$ sinewave signal input)

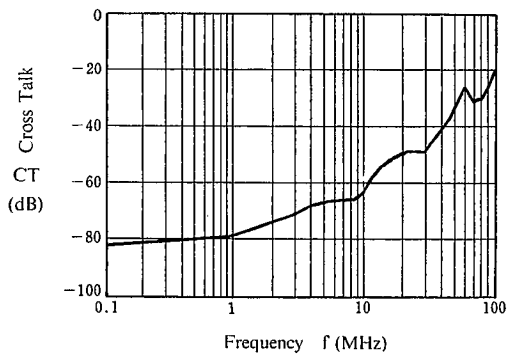

Voltage Gain vs. R_L (Clamp Type Input)

($T_a=25^\circ\text{C}$, $V^+=5\text{V}$, $1\text{V}_{\text{P-P}}$, 1MHz , sinewave signal input)

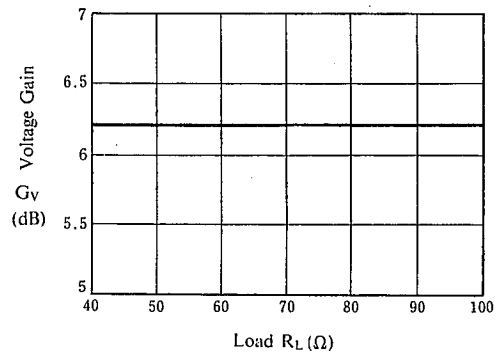

Voltage Gain vs. R_L (Bias Type Input)

($T_a=25^\circ\text{C}$, $V^+=5\text{V}$, $1\text{V}_{\text{P-P}}$, 1MHz sinewave signal input)

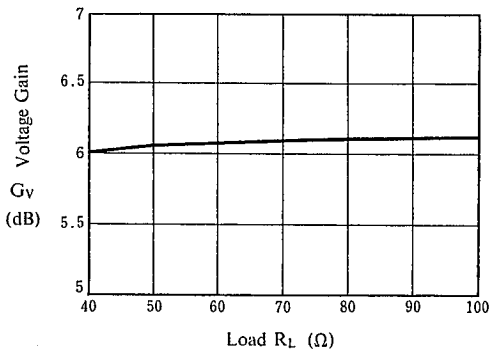

Gain Frequency Characteristics vs. R_L (Clamp Type Input)

($T_a=25^\circ\text{C}$, $V^+=5\text{V}$, $1\text{V}_{\text{P-P}}$, $7\text{MHz}/1\text{MHz}$)

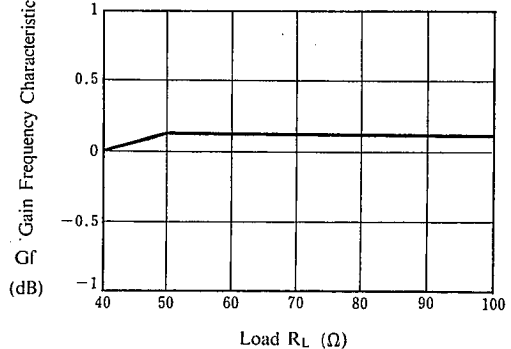

TYPICAL CHARACTERISTICS

Gain Frequency Characteristics vs. R_L (Bias Type Input)
($T_a=25^\circ\text{C}$, $V^+=5\text{V}$, $1V_{P-P}$, $7\text{MHz}/1\text{MHz}$)

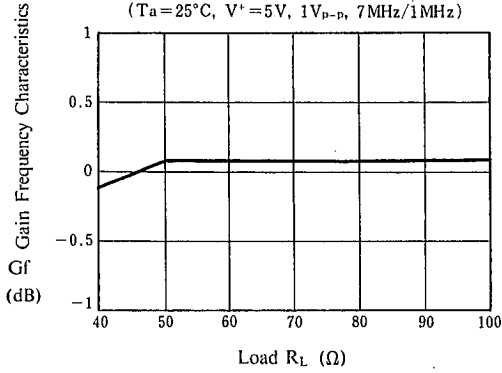

Differential Gain vs. R_L

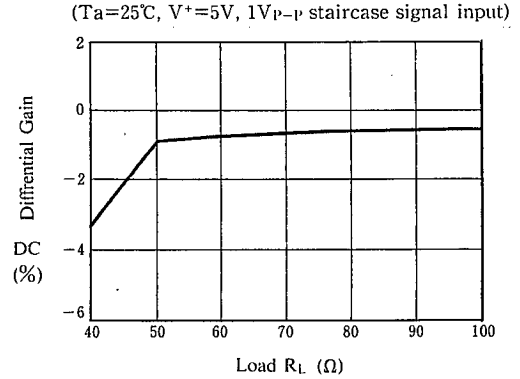

Differential Phase vs. R_L

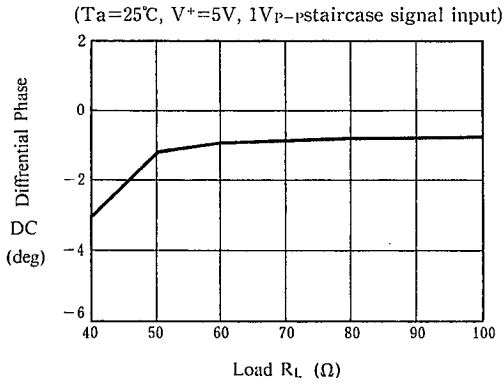

Differential Gain vs. APL

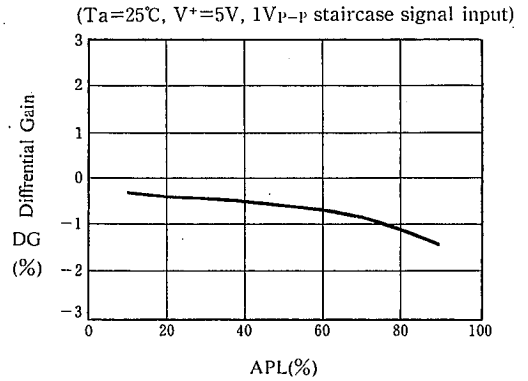

Differential Phase vs. APL

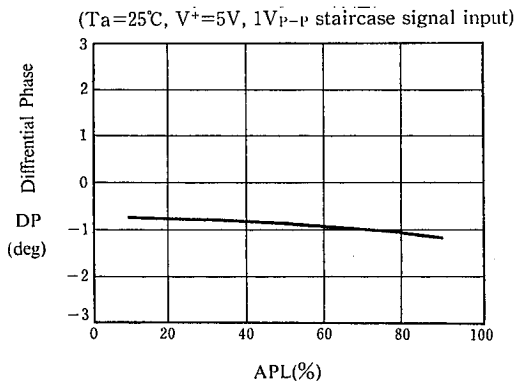

5

MEMO

[CAUTION]

The specifications on this databook are only given for information, without any guarantee as regards either mistakes or omissions. The application circuits in this databook are described only to show representative usages of the product and not intended for the guarantee or permission of any right including the industrial rights.