

2-INPUT SINGLE VIDEO SWITCH

■ GENERAL DESCRIPTION

The **NJM2233B** is 2-input signal video switch selecting one of two video or audio signals. Its operating voltage is 4.75 to 13V and bandwidth is 10MHz. Crosstalk is 70dB (at 4.43MHz). It is applied to both NTSC and PAL VTR.

■ FEATURES

- Operating Voltage (+4.75V to +13V)
- 2 Input-1 Output
- Crosstalk 70dB (at 4.43MHz)
- Package Outline DIP8, DMP8, SIP8, SSOP8
- Bipolar Technology

■ APPLICATION

- VCR Video Camera AV-TV Video Disc player Audio

■ BLOCK DIAGRAM

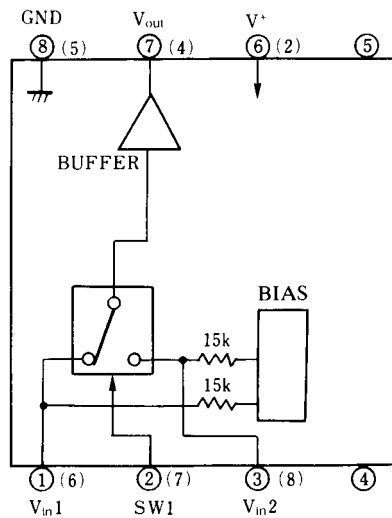

○ : DIP-8, DMP-8 (4, 5Pin NC)
 () : SIP-8 (1, 3pin NC)

■ PACKAGE OUTLINE

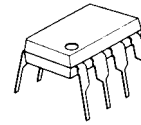

NJM2233BD

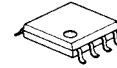

NJM2233BM



NJM2233BV

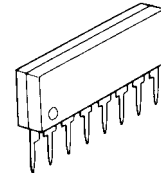

NJM2233BL

■ PIN CONFIGURATION

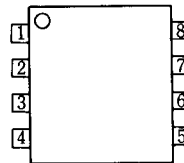

NJM2233BD
NJM2233BM
NJM2233BV

PIN FUNCTION

1. V_{in1}
2. SW1
3. V_{in2}
4. N.C.
5. N.C.
6. V^+
7. V_{out}
8. GND

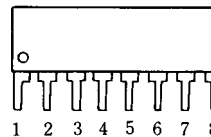

NJM2233BL

PIN FUNCTION

1. N.C.
2. V^+
3. N.C.
4. V_{out}
5. GND
6. V_{in1}
7. SW1
8. V_{in2}

NJM2233B

■ ABSOLUTE MAXIMUM RATINGS

(Ta=25°C)

PARAMETER	SYMBOL	RATINGS	UNIT
Supply Voltage	V^+	15	V
Power Dissipation	P_D	(DIP8) 500 (DMP8) 300 (SIP8) 800 (SSOP8) 250	mW mW mW mW
Operating Temperature Range	T_{opr}	-20 to +75	°C
Storage Temperature Range	T_{stg}	-40 to +125	°C

■ ELECTRICAL CHARACTERISTICS

($V^+=5V$, Ta=25°C)

PARAMETER	SYMBOL	TEST CONDITION	MIN.	TYP.	MAX.	UNIT
Operating Voltage	V^+		4.75	-	13.0	V
Operating Current	I_{oc}	S1=S2=S3=1	-	8.5	11.0	mA
Frequency Characteristic (1)	G_{f1}	$V_i=2.5V_{pp}$ V_o (20Hz)/ V_o (100kHz)	-	0	±1.0	dB
Frequency Characteristic (2)	G_{f2}	$V_i=2.0V_{pp}$ V_o (10MHz)/ V_o (100kHz)	-	0	±1.0	dB
Voltage Gain	G_V	$V_i=2.5V_{pp}$, 100kHz, V_o/V_i	-0.5	0	-	dB
Total Harmonic Distortion	THD	$V_i=2.5V_{pp}$, 1kHz	-	0.01	-	%
Differential Gain	DG	$V_i=2V_{pp}$ standard staircase signal	-	0	-	%
Differential Phase	DP	$V_i=2V_{pp}$ standard staircase signal	-	0	-	deg
Output Offset Voltage	V_{off}	S1=S2=1, S3=1→2, V_o voltage change	-	0	±15	mV
Crosstalk	CT	(S1=S3=1, S2=2) and (S1=S3=2, S2=1) $V_i=2.0V_{pp}$, 4.43MHz, V_o/V_i	-	-70	-	dB
Switch Change Voltage	V_{CH}	Garanteed voltage of all switch on	2.4	-	-	V
	V_{CL}	Garanteed voltage of all switch off	-	-	0.8	V
Input Impedance	R_1		-	1.5	-	KΩ
Output Impedance	R_o		-	10	-	Ω

■ CONTROL SIGNAL – OUTPUT SIGNAL

SW 1	OUTPUT SIGNAL
L	$V_{IN 1}$
H	$V_{IN 2}$

■ TEST CIRCUIT

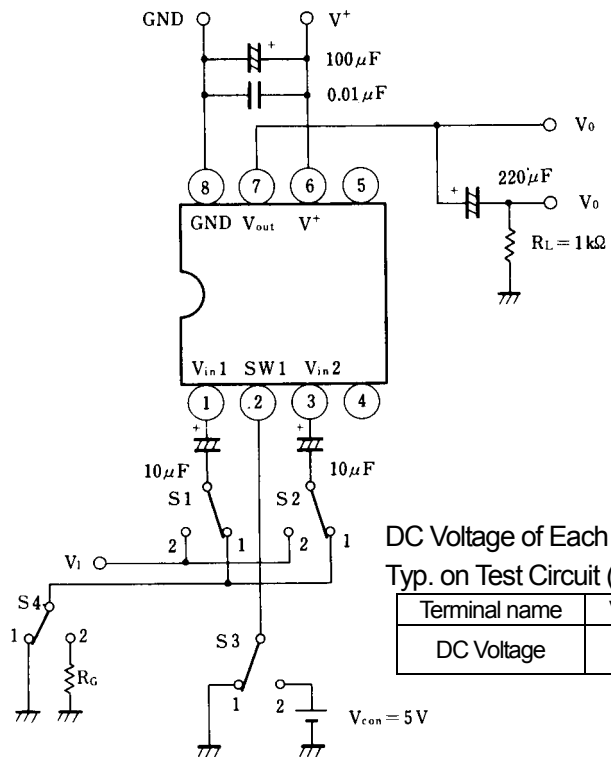

DC Voltage of Each Terminal
Typ. on Test Circuit (Ta=25°C).

Terminal name	V _{IN 1}	SW 1	V _{IN 2}	V ⁺	V _{OUT}	GND
DC Voltage	$\frac{3}{5} V^+$	-	$\frac{3}{5} V^+$	-	$\frac{3}{5} V^+ - 0.7$	-

■ APPLICATION

- Oscillation Prevention on light loading conditions
- Recommended under circuit

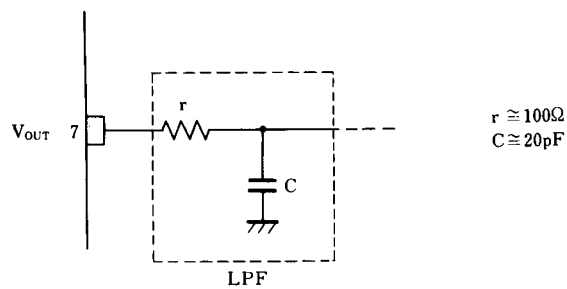

$r \cong 100\Omega$
 $C \cong 20\text{pF}$

■ TYPICAL CHARACTERISTICS

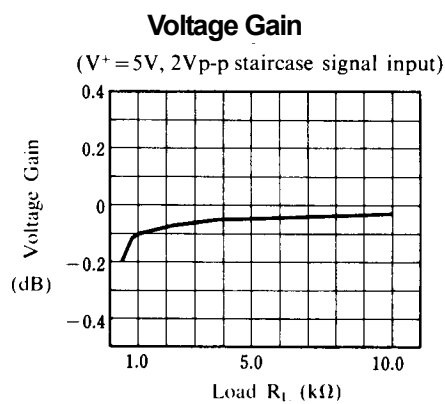
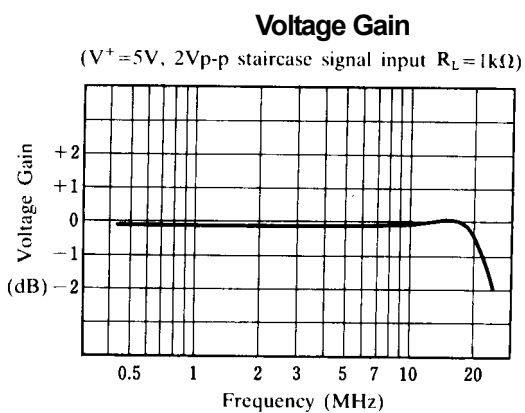
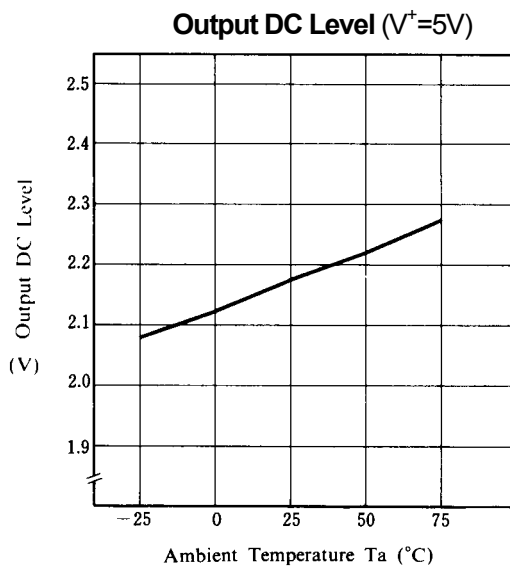
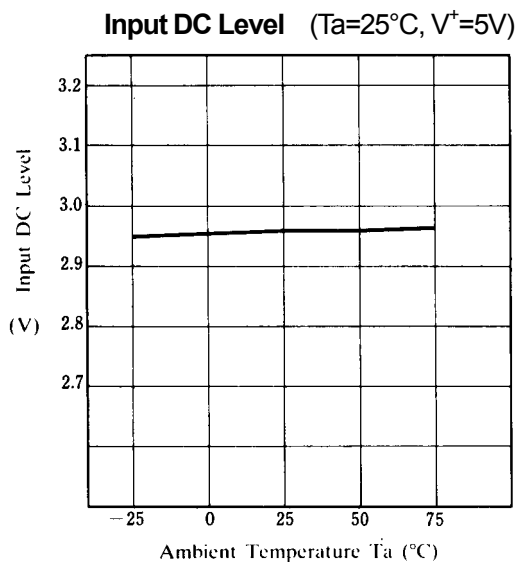
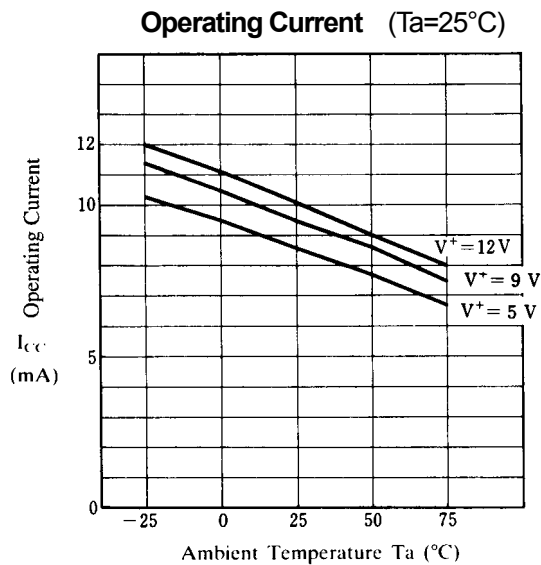
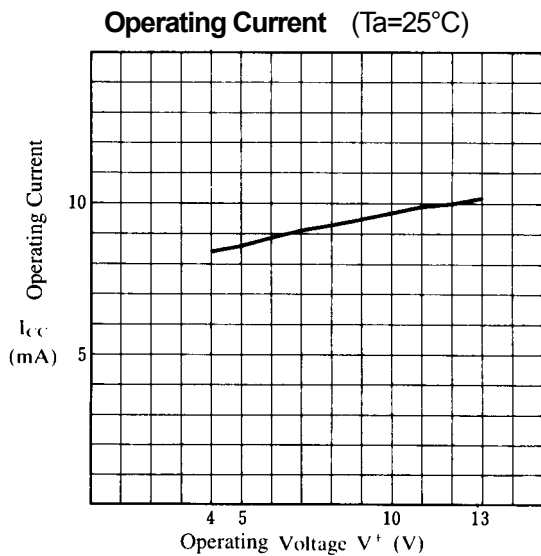

■ TYPICAL CHARACTERISTICS

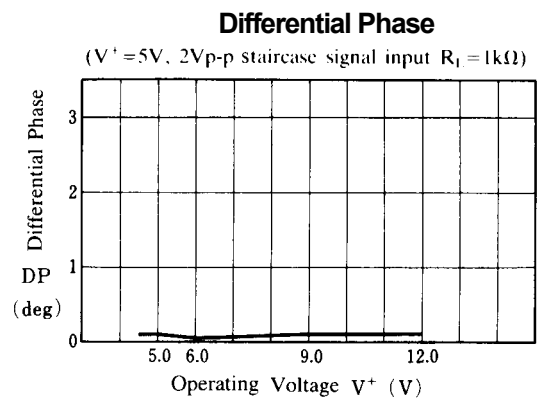
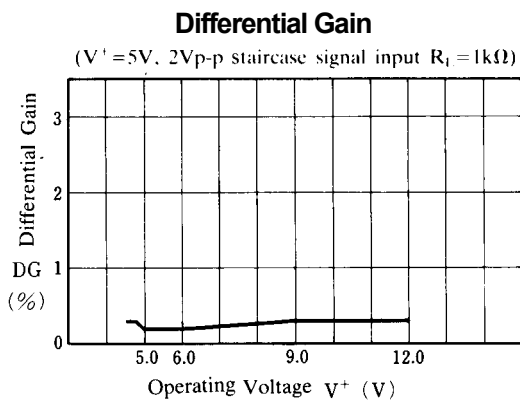
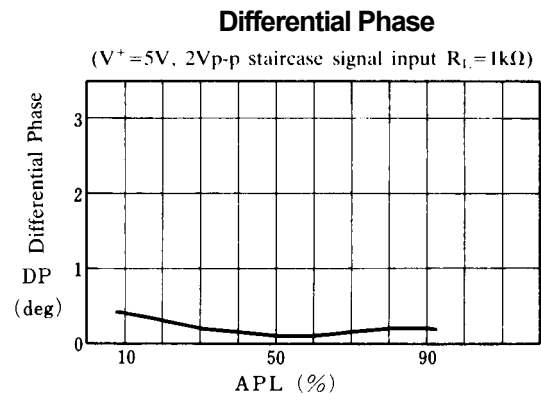
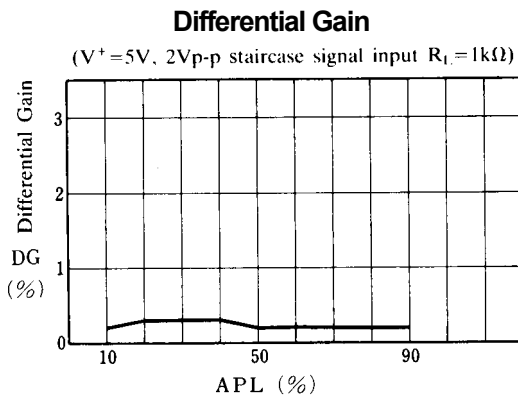
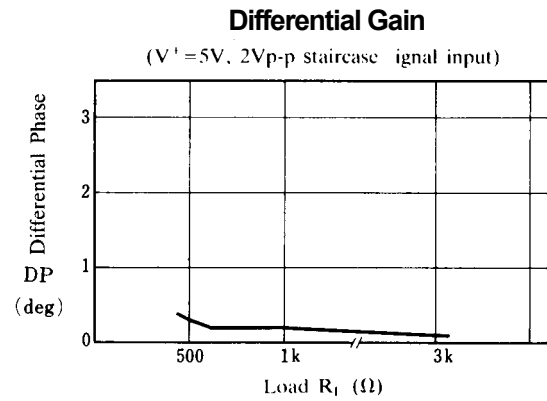
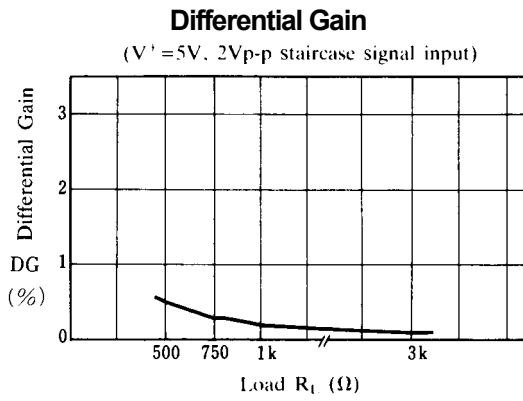

NJM2233B

■ TYPICAL CHARACTERISTICS

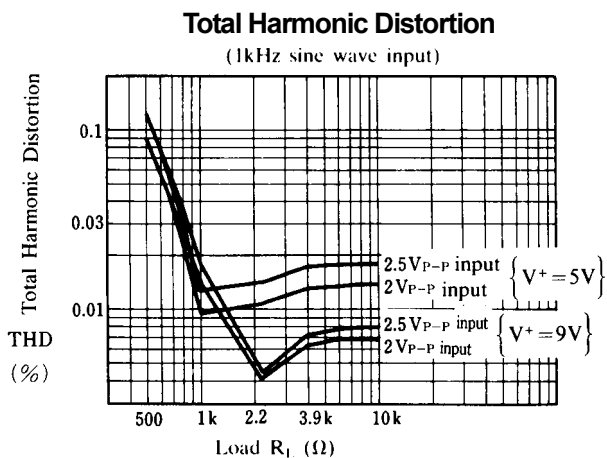
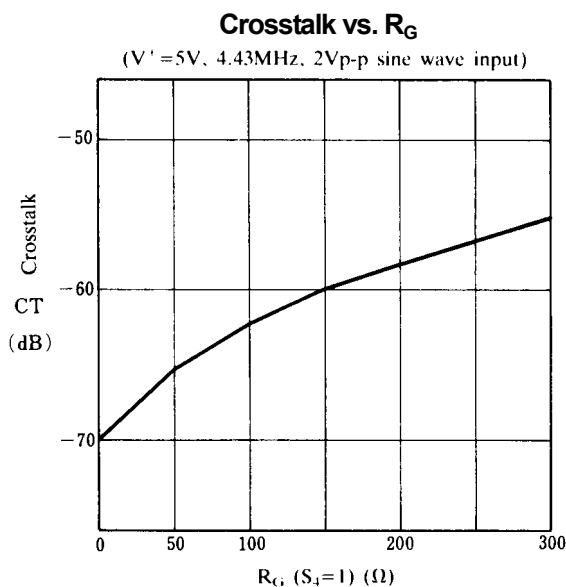
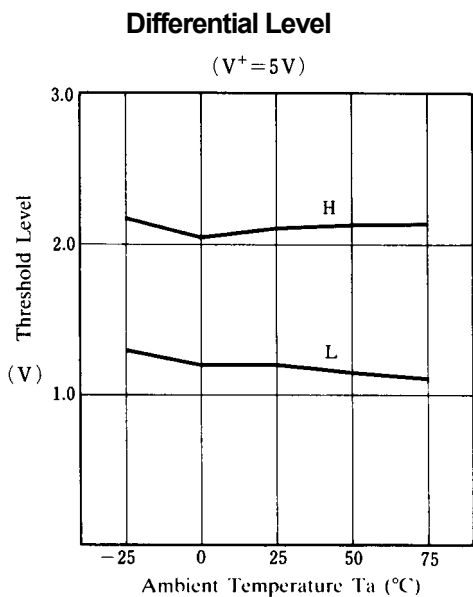
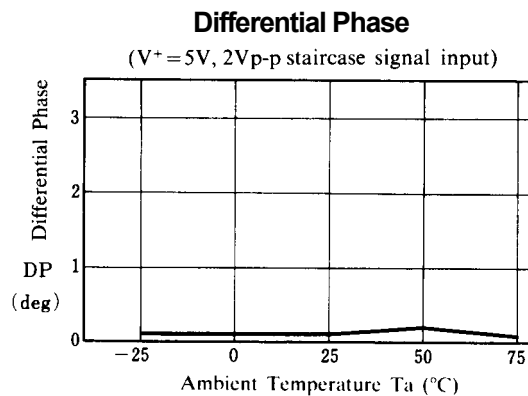
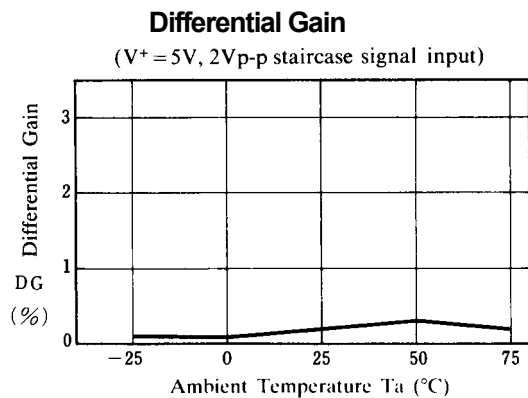

■ EQUIVALENT CIRCUIT

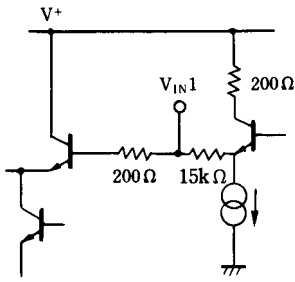
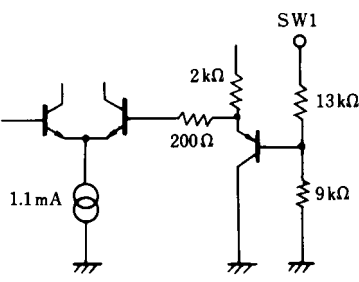
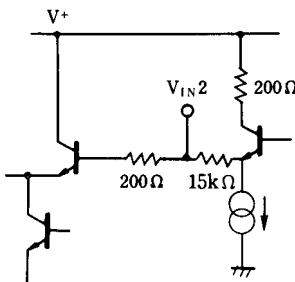
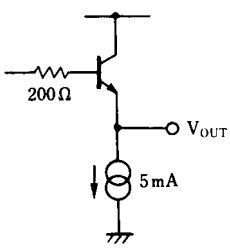
PIN NO.	SYMBOL	INSIDE EQUIVALENT CIRCUIT	PIN NO.	SYMBOL	INSIDE EQUIVALENT CIRCUIT
1	V_{IN-1}		5	NC	_____
2	SW 1		6	V^+	_____
3	V_{IN2}		7	V_{OUT}	
4	NC	_____	8	GND	_____

NJM2233B

■ APPLICATION

This IC requires 0.1uF capacitor between INPUT and GND for bias type input at mute mode.

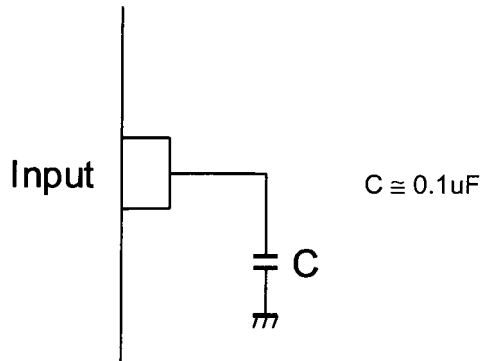

[CAUTION]

The specifications on this databook are only given for information, without any guarantee as regards either mistakes or omissions. The application circuits in this databook are described only to show representative usages of the product and not intended for the guarantee or permission of any right including the industrial rights.