

QUAD OPERATIONAL AMPLIFIER

■ GENERAL DESCRIPTION

The NJM2059 integrated circuit is a quad high-gain operational amplifier internally compensated and constructed on a single silicon chip using an advanced epitaxial process.

The NJM2059 has wider unity gain bandwidth and larger slew rate compared to the NJM2058.

Each amplifier of the NJM2059 has the same electrical characteristics of the NJM4559.

■ PACKAGE OUTLINE

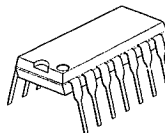

NJM2059D

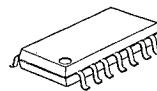

NJM2059M



NJM2059V

■ FEATURES

- Operating Voltage (±4V ~ ±18V)
- Slew Rate (2V/μs typ.)
- Unity Gain Bandwidth (6MHz typ.)
- Package Outline DIP14, DMP14, (SSOP14)
- Bipolar Technology

■ PIN CONFIGURATION

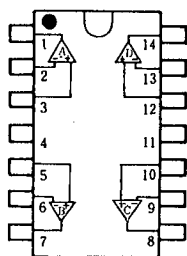

NJM2059D  
NJM2059M  
NJM2059L

PIN FUNCTION

- |                   |                    |
|-------------------|--------------------|
| 1. A OUTPUT       | 8. C OUTPUT        |
| 2. A-INPUT        | 9. C-INPUT         |
| 3. A+INPUT        | 10. C+INPUT        |
| 4. V <sup>+</sup> | 11. V <sup>-</sup> |
| 5. B+INPUT        | 12. D+INPUT        |
| 6. B-INPUT        | 13. D-INPUT        |
| 7. B OUTPUT       | 14. D OUTPUT       |

■ EQUIVALENT CIRCUIT (1/4 Shown)

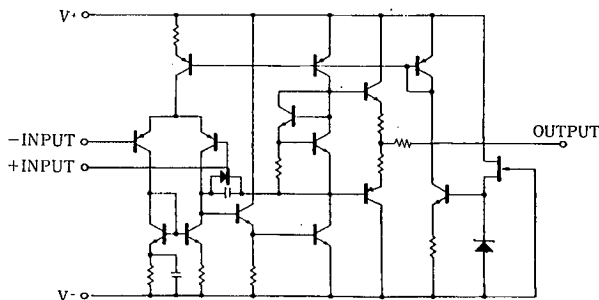

4

■ ABSOLUTE MAXIMUM RATINGS

(Ta=25°C)

| PARAMETER                   | SYMBOL                         | RATINGS              | UNIT |
|-----------------------------|--------------------------------|----------------------|------|
| Supply Voltage              | V <sup>+</sup> /V <sup>-</sup> | ±18                  | V    |
| Differential Input Voltage  | V <sub>ID</sub>                | ±30                  | V    |
| Input Voltage               | V <sub>IC</sub>                | ±15 (note 1)         | V    |
| Power Dissipation           | P <sub>D</sub>                 | (DIP14) 700          | mW   |
|                             |                                | (DIM14) 700 (note 2) | mW   |
|                             |                                | (SSOP14) 300         | mW   |
| Operating Temperature Range | T <sub>opr</sub>               | -40 ~ +85            | °C   |
| Storage Temperature Range   | T <sub>stg</sub>               | -40 ~ +125           | °C   |

(note 1) For supply voltage less than ±15V, the absolute maximum input voltage is equal to the supply voltage.

(note 2) At on PC board

■ ELECTRICAL CHARACTERISTICS

(Ta=25°C, V<sup>+</sup>/V<sup>-</sup>=±15V)

| PARAMETER                       | SYMBOL           | TEST CONDITION                              | MIN. | TYP. | MAX. | UNIT  |
|---------------------------------|------------------|---------------------------------------------|------|------|------|-------|
| Input Offset Voltage            | V <sub>IO</sub>  | R <sub>S</sub> ≤ 10kΩ                       | —    | 0.5  | 6    | mV    |
| Input Offset Current            | I <sub>IO</sub>  |                                             | —    | 5    | 200  | nA    |
| Input Bias Current              | I <sub>B</sub>   |                                             | —    | 20   | 500  | nA    |
| Input Resistance                | R <sub>IN</sub>  |                                             | 0.3  | 1    | —    | MΩ    |
| Large Signal Voltage Gain       | A <sub>V</sub>   | R <sub>L</sub> ≥ 2kΩ, V <sub>O</sub> = ±10V | 86   | 100  | —    | dB    |
| Maximum Output Voltage Swing 1  | V <sub>OM1</sub> | R <sub>L</sub> ≥ 10kΩ                       | ±12  | ±14  | —    | V     |
| Maximum Output Voltage Swing 2  | V <sub>OM2</sub> | R <sub>L</sub> ≥ 2kΩ                        | ±10  | ±13  | —    | V     |
| Input Common Mode Voltage Range | V <sub>ICM</sub> |                                             | ±12  | ±14  | —    | V     |
| Common Mode Rejection Ratio     | CMR              | R <sub>S</sub> ≤ 10kΩ                       | 70   | 90   | —    | dB    |
| Supply Voltage Rejection Ratio  | SVR              | R <sub>S</sub> ≤ 10kΩ                       | 76.5 | 90   | —    | dB    |
| Operating Current               | I <sub>CC</sub>  |                                             | —    | 7    | 11.3 | mA    |
| Slew Rate                       | SR               |                                             | —    | 2    | —    | V/μs  |
| Equivalent Input Noise Voltage  | V <sub>NI</sub>  | RIAA, R <sub>S</sub> = 2.2kΩ, 30kHz LPF     | —    | 1.4  | —    | μVrms |

4

## TYPICAL CHARACTERISTICS

### Open Loop Voltage Gain vs. Frequency

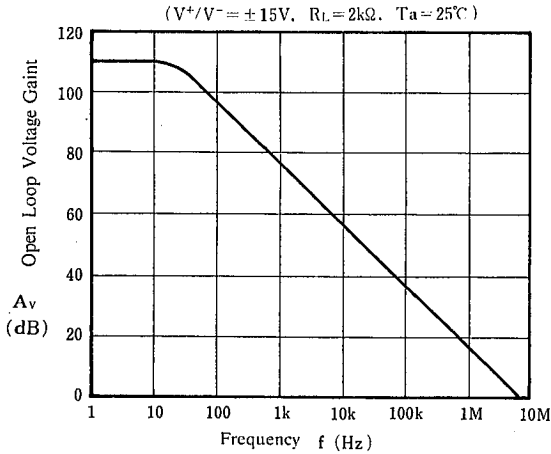

### Maximum Output Voltage Swing vs. Load Resistance

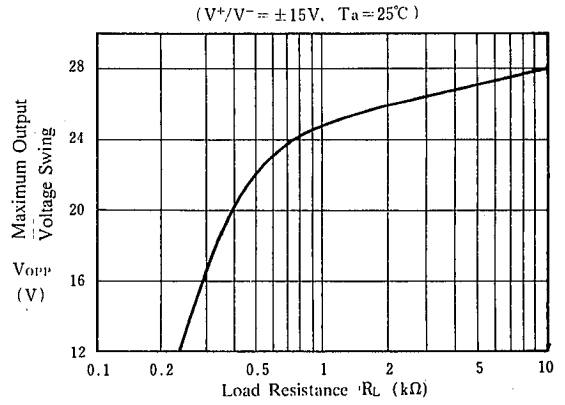

### Maximum Output Voltage Swing vs. Frequency

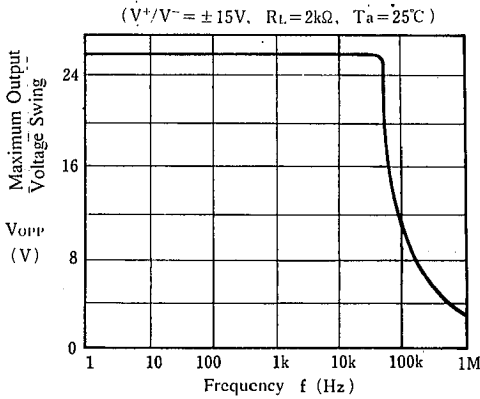

### Equivalent Input Noise Voltage vs. Frequency

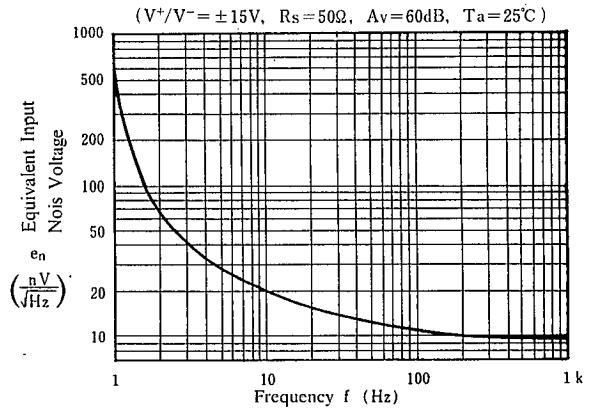

### Maximum Output Voltage Swing vs. Operating Voltage

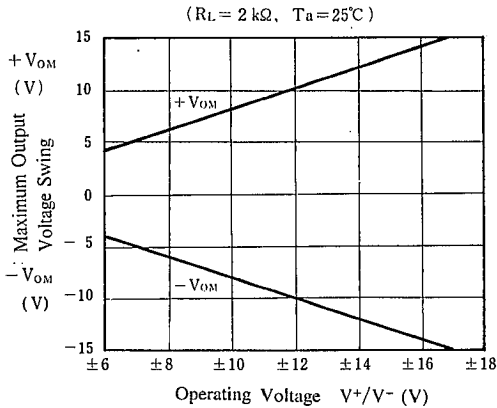

■ TYPICAL CHARACTERISTICS

Operating Current vs. Temperature

( $V^+/V^- = \pm 15V$ )

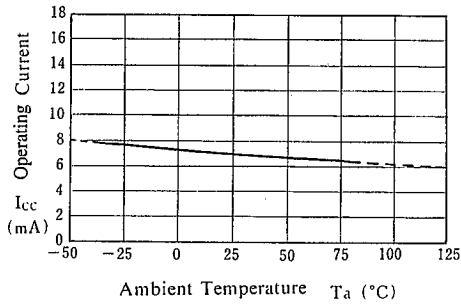

Maximum Output Voltage Swing vs. Temperature

( $V^+/V^- = \pm 15V, R_L = 10k\Omega$ )

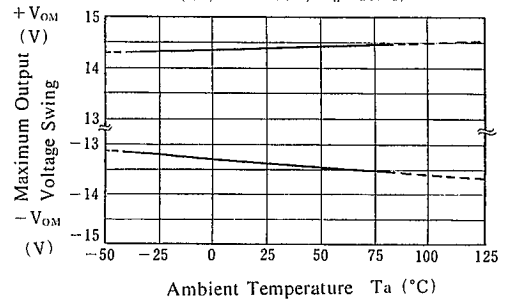

Input Offset voltage vs. Temperature

( $V^+/V^- = \pm 15V$ )

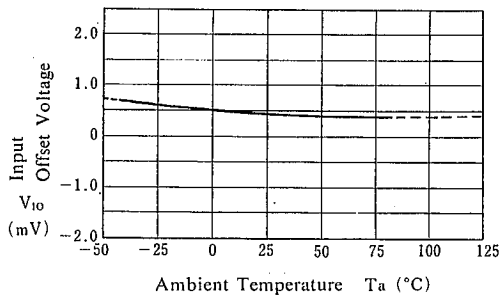

Input Bias Current vs. Temperature

( $V^+/V^- = \pm 15V$ )

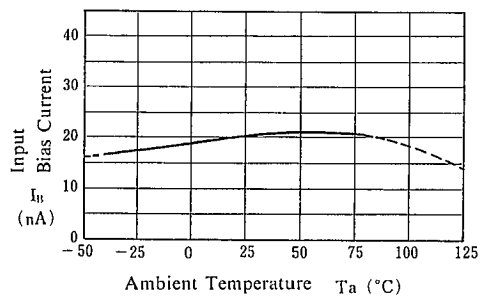

4

## ■ TYPICAL CHARACTERISTICS

### Total Harmonic Distortion

( $V^+/V^- = \pm 15V$ , Gain = 40dB,  $R_L = 10k\Omega$ ,  
 $T_a = 25^\circ C$ )

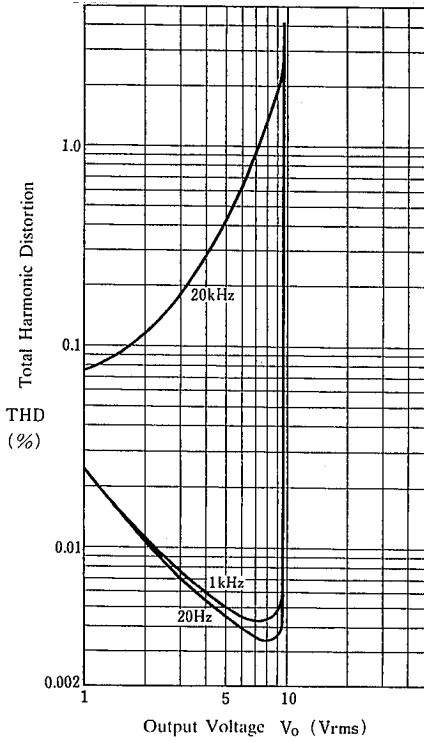

### Total Harmonic Distortion

( $V^+/V^- = \pm 15V$ , Gain = 40dB,  $R_L = 2k\Omega$ ,  
 $T_a = 25^\circ C$ )

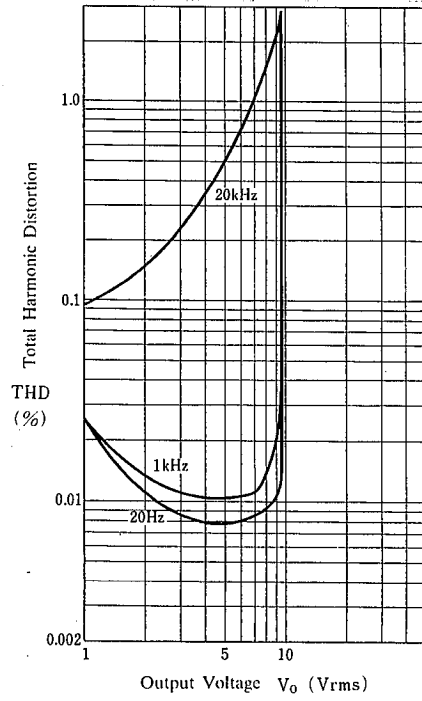

4

## MEMO

[CAUTION]

The specifications on this databook are only given for information, without any guarantee as regards either mistakes or omissions. The application circuits in this databook are described only to show representative usages of the product and not intended for the guarantee or permission of any right including the industrial rights.