

# MZ8813 / MZ8813C



## Triple-Balanced Mixer

Rev. V3

### Features

- LO 2 to 18 GHz
- RF 2 to 18 GHz
- IF 1 to 8 GHz
- LO Drive +13 dBm (nominal)
- Wide Bandwidth
- Available with Field Replaceable Connectors

### Description

The MZ8813 is a triple balanced mixer, designed for use in military, commercial and test equipment applications. The design utilizes Schottky ring quad diodes and broadband soft dielectric baluns to attain excellent performance. The use of high temperature solder and welded assembly processes used internally makes it ideal for use in manual, semi-automated assembly. Environmental screening available to MIL-STD-883, MIL-STD-202 or MIL-DTL-28837, consult factory.

### Ordering Information

Part Number	Package
MZ8813	Versapac
MZ8813C	SMA Connectorized

### Product Image

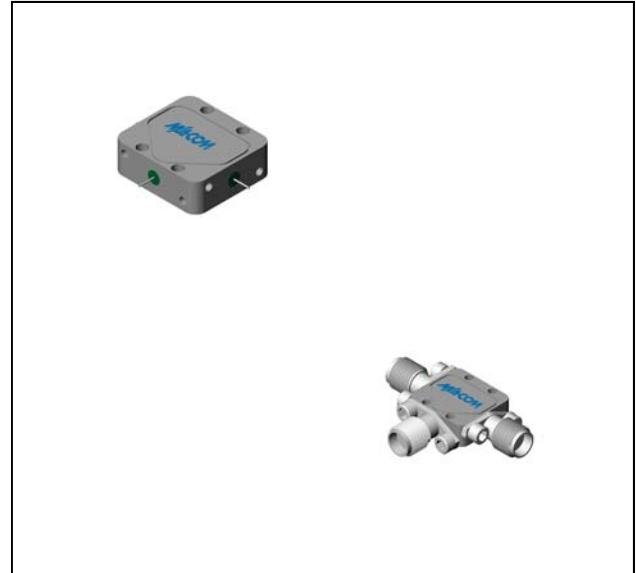

### Electrical Specifications: $Z_0 = 50\Omega$ $Lo = +13$ dBm (Downconverter application only)

Parameter	Test Conditions	Units	Typical	Guaranteed	
				+25°C	-54° to +85°C
SSB Conversion Loss (max)	fR = 3 to 10 GHz, fL = 2 to 15 GHz, fl = 1 to 5 GHz fR = 2 to 18 GHz, fL = 2 to 18 GHz, fl = 1 to 8 GHz	dB	6.5 7.5	9.0 11.0	9.5 11.5
SSB Noise Figure (max)	Within 1 dB of conversion loss	dB	—	—	—
Isolation, L to R (min)	fL = 2 to 18 GHz	dB	25	15	13
Isolation, L to I (min)	fL = 2 to 18 GHz	dB	28	16	14
1 dB Conversion Comp.	fL = +13 dBm	dBm	+8		
Input IP3	fR1 = 3 GHz at -10 dBm, fR2 = 3.01 GHz at -10 dBm, fL = 5 GHz at +13 dBm fR1 = 17.99 GHz at -10 dBm, fR2 = 18 GHz at -10 dBm, fL = 14 GHz at +13 dBm	dBm	+19 +16		

### Typical Performance Curves

Conversion vs. Frequency

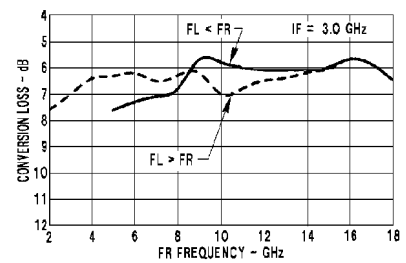
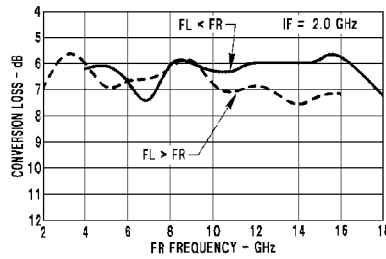
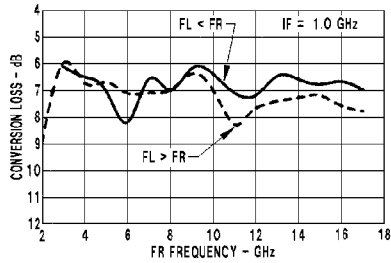

Conversion vs. Frequency

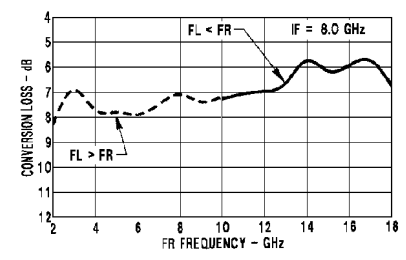
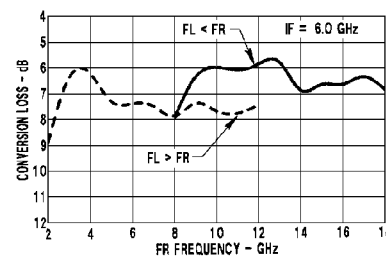
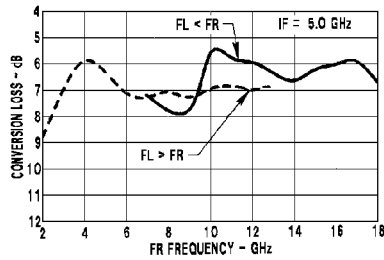

Conversion Loss vs. LO Power

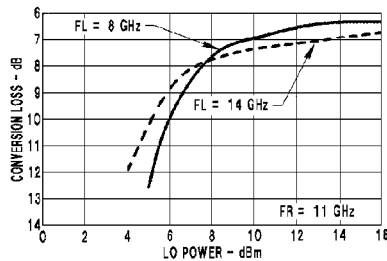

Isolation vs. Frequency

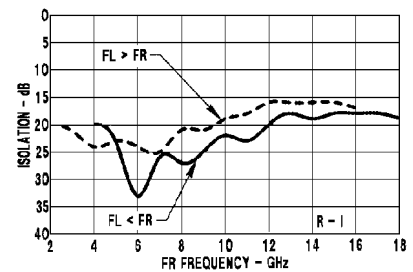
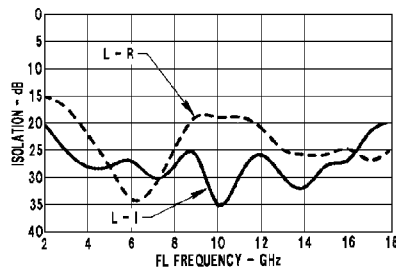

# MZ8813 / MZ8813C



## Triple-Balanced Mixer

Rev. V3

### Absolute Maximum Ratings

Parameter	Absolute Maximum
Operating Temperature	-54°C to +100°C
Storage Temperature	-65°C to +100°C
Peak Input Power	+26 dBm max @ +25°C +23 dBm max @ +100°C
Peak Input Current	100 mA DC

### I-Port VSWR vs. Frequency

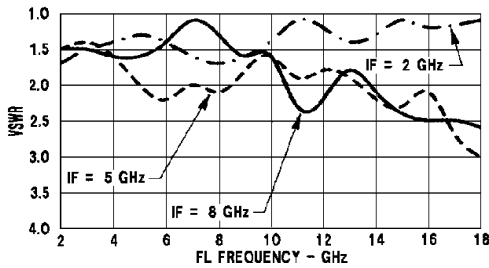

### L-Port VSWR vs. Frequency

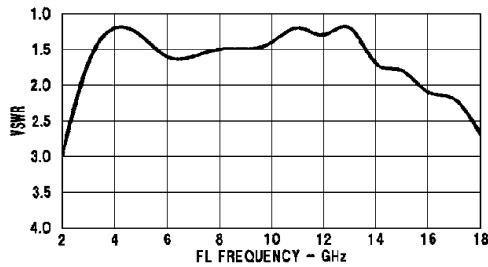

### R-Port VSWR vs. Frequency

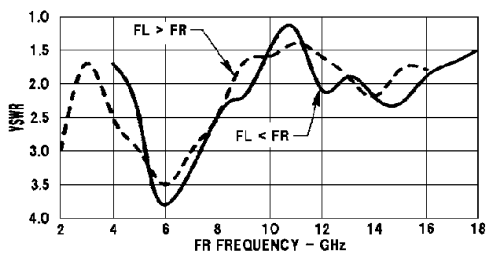

### Outline Drawing: Versapac \*

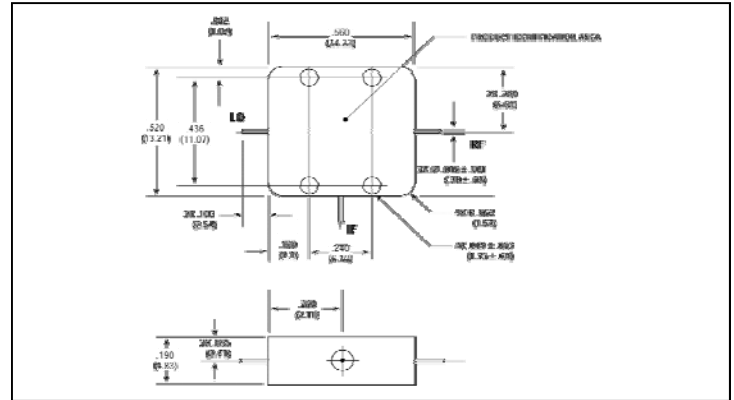

Weight: 4 grams (0.14 oz.) max

### Outline Drawing: SMA Connectorized \*

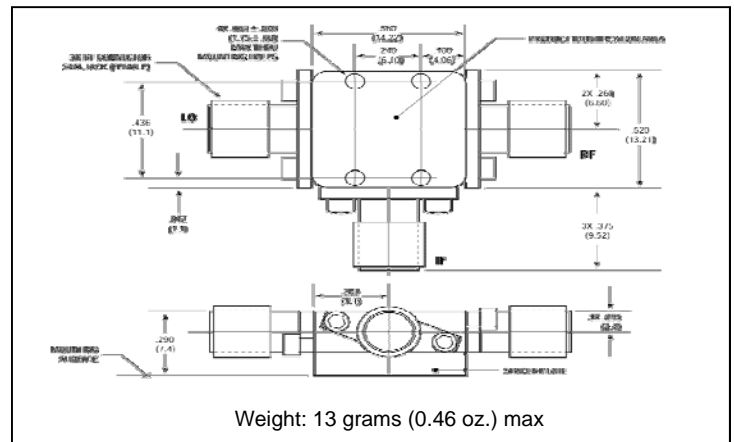

Weight: 13 grams (0.46 oz.) max

\* Dimensions are inches (millimeters) ±0.015 (0.38) unless otherwise specified.