

The MRFIC Line

1.8 GHz Upconverter

Designed primarily for use in DECT, Japan's Personal Handy System (PHS), and other wireless Personal Communication Systems (PCS) applications at 1.8 GHz, but also applicable to Industrial, Scientific and Medical (ISM) applications at 2.5 GHz. The MRFIC1803 is a complete active upmixer, exciter amplifier, and LO buffer amplifier in a low-cost SOIC-16 package. The low power consumption design includes a single balanced active mixer, CMOS compatible receive and transmit enable inputs, a buffer/exciter amplifier, and a buffered LO output capable of driving the MRFIC1804 downconverter. IF, LO and RF ports are matched to 50 Ω and no off-chip baluns are required. With both TX and RX enable pins low, the device is in standby mode and draws less than 0.3 mA.

Together with the rest of the MRFIC180X series, this GaAs IC family offers the complete transmit and receive functions, less LO and filters, needed for a typical 1.8 GHz cordless telephone.

- 10 dB IF to RF Conversion Gain
- Usable Frequency Range = 1.7 to 2.5 GHz
- Low Power Consumption = 80 mW (Typ)
- Single Bias Supply = 2.7 to 3.3 V
- No External Baluns Required
- IF, LO and RF Ports Matched to 50 Ω
- Low LO Power Requirement = -10 dBm (Typ)
- Low Cost Surface Mount Plastic Package
- Order MRFIC1803R2 for Tape and Reel.
R2 Suffix = 2,500 Units per 16 mm, 13 inch Reel.
- Device Marking = M1803

MRFIC1803

**1.8 GHz UPMIXER,
EXCITER AND LO AMP
GaAs MONOLITHIC
INTEGRATED CIRCUIT**

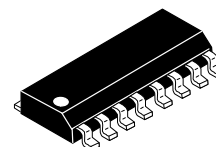

**CASE 751B-05
(SO-16)**

MAXIMUM RATINGS ($T_A = 25^\circ\text{C}$ unless otherwise noted)

Ratings	Symbol	Value	Unit
Supply Voltage	V_{DD}	5.5	Vdc
IF Input Power	P_{IF}	3	dBm
LO Input Power	P_{LO}	3	dBm
Transmit and Receive Enable Voltage	TX EN, RX EN	5.5	Vdc
Storage Temperature Range	T_{stg}	-65 to +150	$^\circ\text{C}$
Operating Ambient Temperature	T_A	-30 to +85	$^\circ\text{C}$

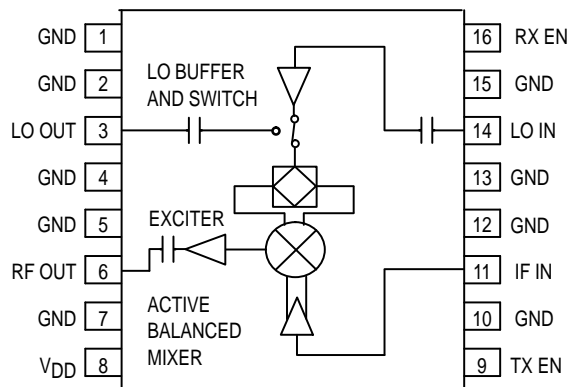

Pin Connections and Functional Block Diagram

RECOMMENDED OPERATING RANGES

Parameter	Symbol	Value	Unit
LO Input Frequency	f_{LO}	1.5 to 2.4	GHz
LO Input Power	P_{LO}	-10	dBm
IF Input Frequency	f_{IF}	70 to 350	MHz
RF Output Frequency	f_{RF}	1.7 to 2.5	GHz
Transmit and Receive Enable Voltage	TX EN, RX EN	2.7 to V_{DD}	Vdc
Supply Voltage	V_{DD}	2.7 to 5	Vdc

ELECTRICAL CHARACTERISTICS ($V_{DD} = 3\text{ V}$, $T_A = 25^\circ\text{C}$, $LO = 1790\text{ MHz @ } -10\text{ dBm}$, $IF = 110\text{ MHz @ } -15\text{ dBm}$, $TX EN = 3.0\text{ V}$, $RX EN = 0\text{ V}$, unless otherwise noted)

Characteristic	Min	Typ	Max	Unit
IF to RF Conversion Gain	8	10	—	dB
RF Output 1 dB Compression	—	-2	—	dBm
RF Output 3rd Order Intercept	—	9	—	dBm
LO Feed Through to RF Port	—	-19	—	dBm
Auxiliary LO Output Power (TX EN = 0 V, RX EN = 3 Vdc)	—	-4	—	dBm
Supply Current, TX Mode	—	28	50	mA
Supply Current, RX Mode (TX EN = 0 V, RX EN = 3 Vdc)	—	3	—	mA
Standby Mode Current (TX EN = 0 V, RX EN = 0 Vdc)	—	0.1	0.3	mA

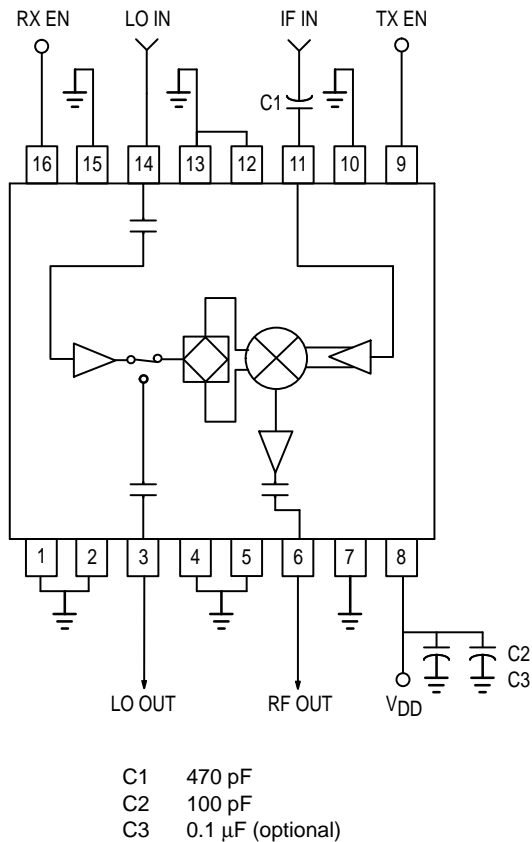

Figure 1. Applications Circuit Configuration

Typical Characteristics

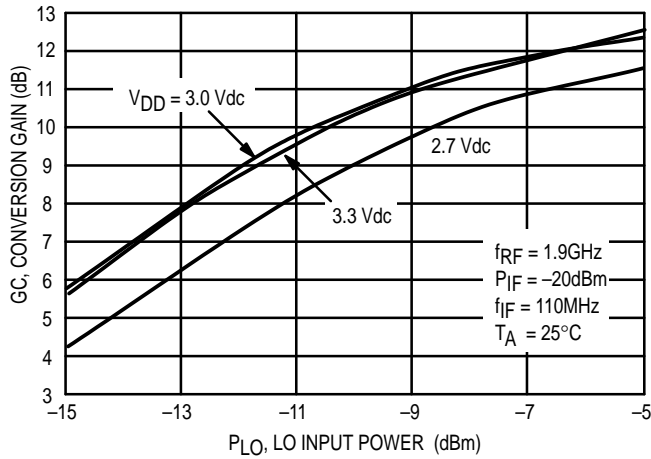

Figure 2. Conversion Gain versus LO Power

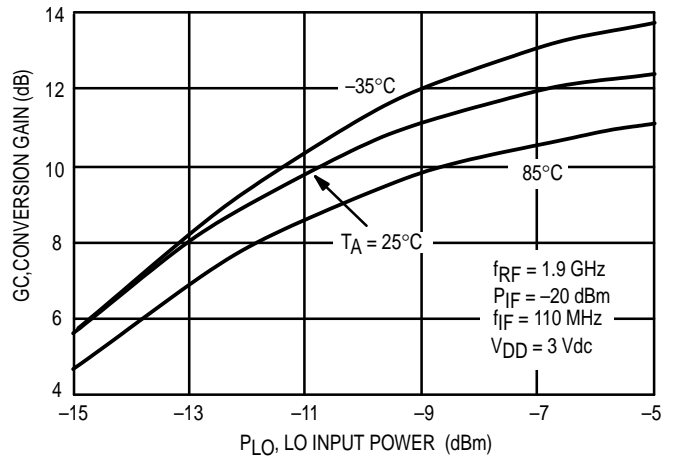

Figure 3. Conversion Gain versus LO Power

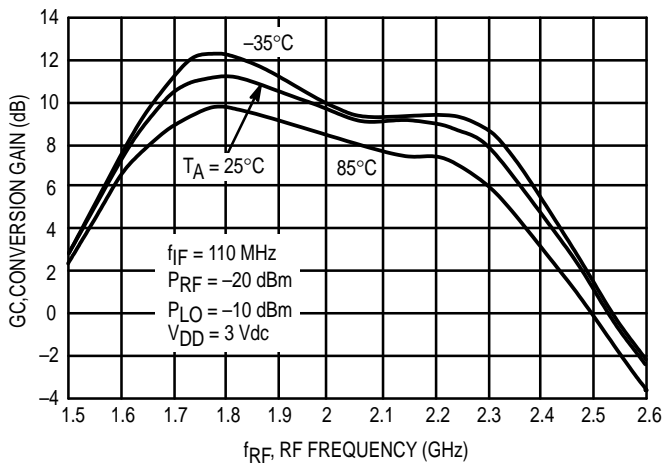

Figure 4. Conversion Gain versus RF Frequency

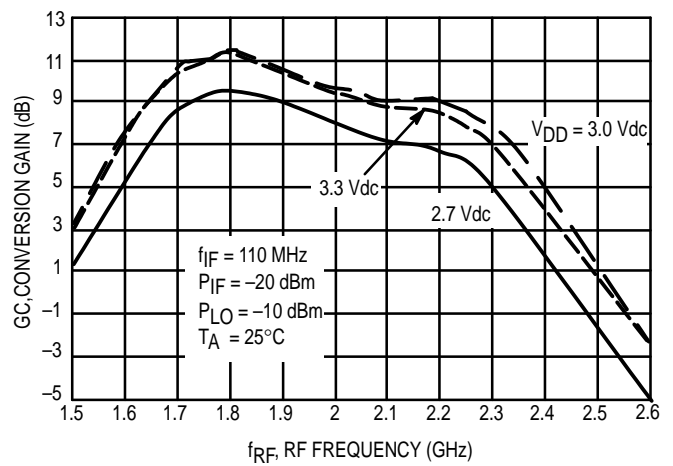

Figure 5. Conversion Gain versus RF Frequency

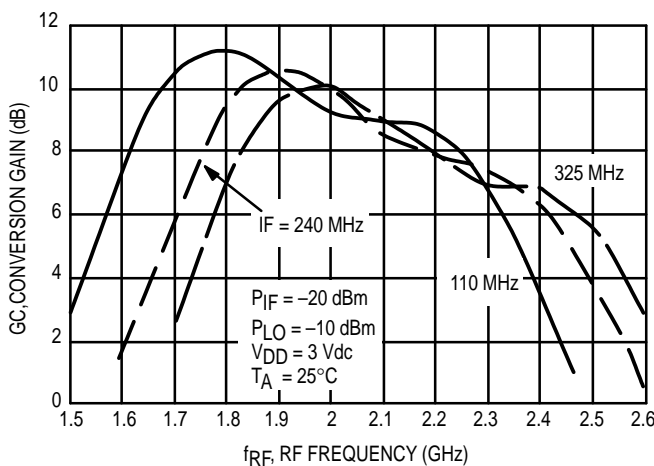

Figure 6. Conversion Gain versus RF Frequency

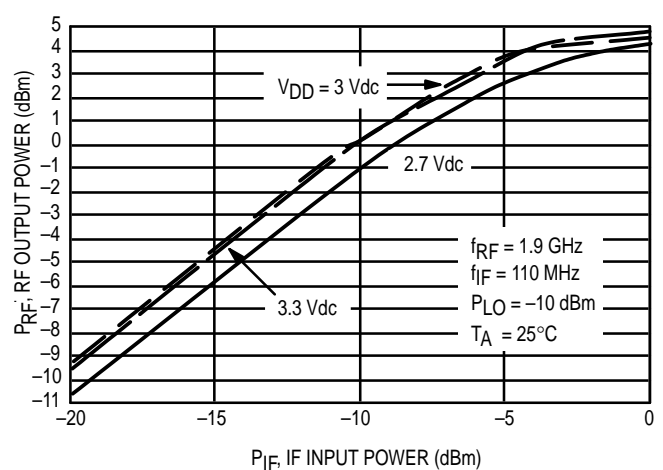

Figure 7. RF Output Power versus IF Input Power

Typical Characteristics

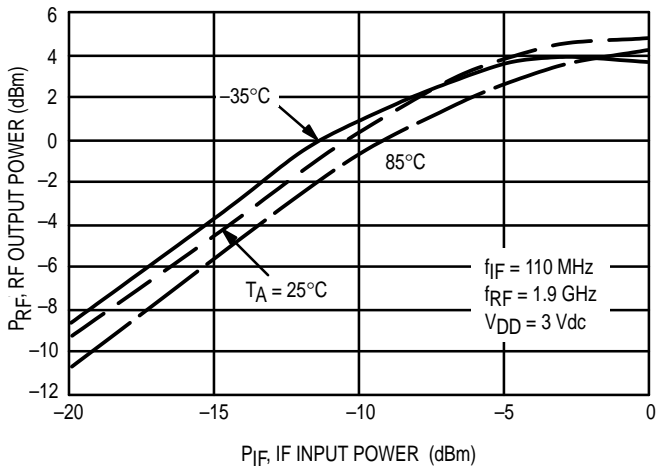

Figure 8. RF Output Power versus IF Input Power

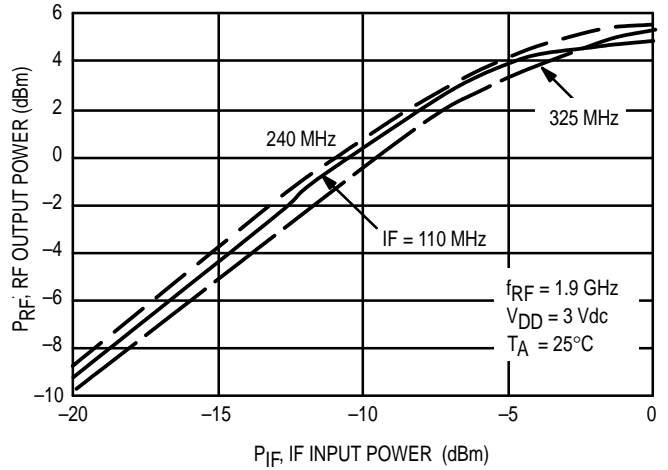

Figure 9. RF Output Power versus IF Input Power

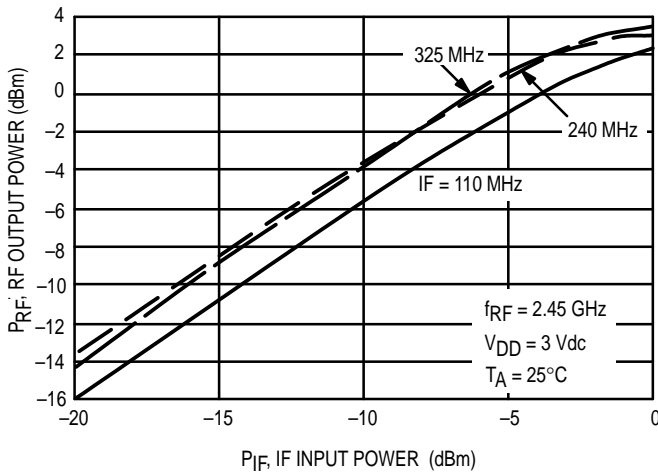

Figure 10. RF Output Power versus IF Input Power at 2.45GHz

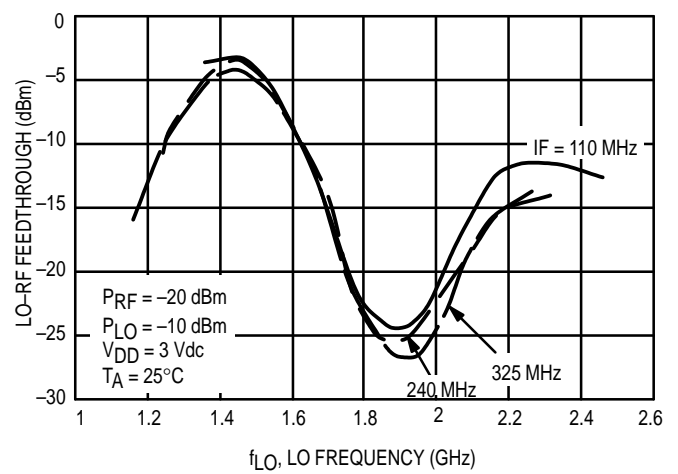

Figure 11. LO to RF Feedthrough versus LO Frequency

Frequency (MHz)	RF Output	LO Input	LO Output
1500	22.07 -j11.36	41.98 +j22.31	20.09 +j31.15
1550	21.74 -j4.69	50.60 +j9.80	26.39 +j40.79
1600	22.28 +j2.16	41.93 -j0.07	37.63 +j52.47
1650	24.01 +j8.25	32.74 +j3.32	56.16 +j63.47
1700	26.64 +j14.13	28.78 +j11.39	87.97 +j67.31
1750	30.83 +j20.11	28.98 +j21.04	131.33 +j40.34
1800	36.39 +j25.30	32.13 +j30.26	137.85 -j16.48
1850	43.92 +j29.26	37.68 +j40.38	103.88 -j50.81
1900	54.37 +j30.98	48.31 +j54.15	69.58 -j53.97
1950	65.34 +j28.57	68.80 +j70.87	50.13 -j46.24
2000	75.30 +j21.12	118.18 +j86.46	38.97 -j36.86
2050	81.19 +j8.43	220.83 +j17.19	32.08 -j27.58
2100	80.22 -j4.24	148.91 -j120.77	28.43 -j19.86
2150	74.20 -j14.00	58.50 -j105.11	26.56 -j12.82
2200	65.50 -j19.72	27.23 -j71.51	26.03 -j5.89
2250	57.40 -j21.38	17.22 -j50.26	26.73 -j0.03
2300	50.59 -j20.61	13.00 -j35.19	28.46 +j5.10
2350	44.53 -j18.16	10.95 -j22.96	30.88 +j9.86
2400	40.24 -j14.78	10.23 -j13.58	33.75 +j13.92
2450	37.73 -j10.54	10.20 -j5.32	37.50 +j17.32
2500	36.38 -j6.72	10.62 +j2.90	42.00 +j20.34

Table 1. Selected Device Impedances

DESIGN AND APPLICATIONS INFORMATION

The MRFIC1803 combines a single-balanced FET mixer with an LO pre-amp and an exciter amplifier to form a self-contained upconverter. The device is usable from RF frequencies of 1.7 to 2.5 GHz and at IF frequencies of 70 to 325 MHz. The design is optimized for low side injection in heterodyne transmitter applications. In the upconversion process, modulation is imparted to an IF carrier which is converted to the RF transmit frequency by a mixer. By DC coupling the IF input, the device can be used for simple on-off keying (OOK) or bi-phase shift keying (BPSK) applications with no IF.

The MRFIC1803 design minimizes the need for off-chip components. An active balun is employed at the IF input and provides an excellent broadband 50Ω match over the full range of IF frequencies. The LO quadrature divider is passive and internal to the device. The LO buffer amplifier is equipped with a diversity switch which switches the amplified LO signal to the LO output pin during RECEIVE mode. The -5 dBm LO output is the appropriate level to drive the MRFIC1804 for 1.8 GHz applications or the MRFIC2401 for 2.4 GHz applications.

As shown in Figure 1, the device is easy to use with minimal off-chip components. More or less bypassing of the control and supply lines may be required depending on board layout and shielding. Careful layout of the RF

frequency portions of the board is critical to successful implementation. Controlled impedance lines must be used and any off-chip components must be mounted as close to the IC as possible. The applications circuit was used to gather the information displayed in the typical characteristics curves. Since the MRFIC1803 design was optimized for the 1.7 to 1.9 GHz frequency range, improved performance can be had with some off-chip matching at frequencies outside this range. In particular, matching of the LO port will supply higher LO drive and improve conversion gain. At the RF output, either better gain or better 1dB compression can be had with external matching.

Filtering is generally required in the upconversion process to reduce image and LO radiation. To minimize pin count, this filtering is accomplished external to the device at the exciter output. For the frequency ranges of application, two and three pole ceramic surface filters are available at reasonable cost and with less than 2 dB of loss.

EVALUATION BOARDS

Evaluation boards are available for RF Monolithic Integrated Circuits by adding a "TF" suffix to the device type. For a complete list of currently available boards and ones in development for newly introduced product, please contact your local Motorola Distributor or Sales Office.

PACKAGE DIMENSIONS

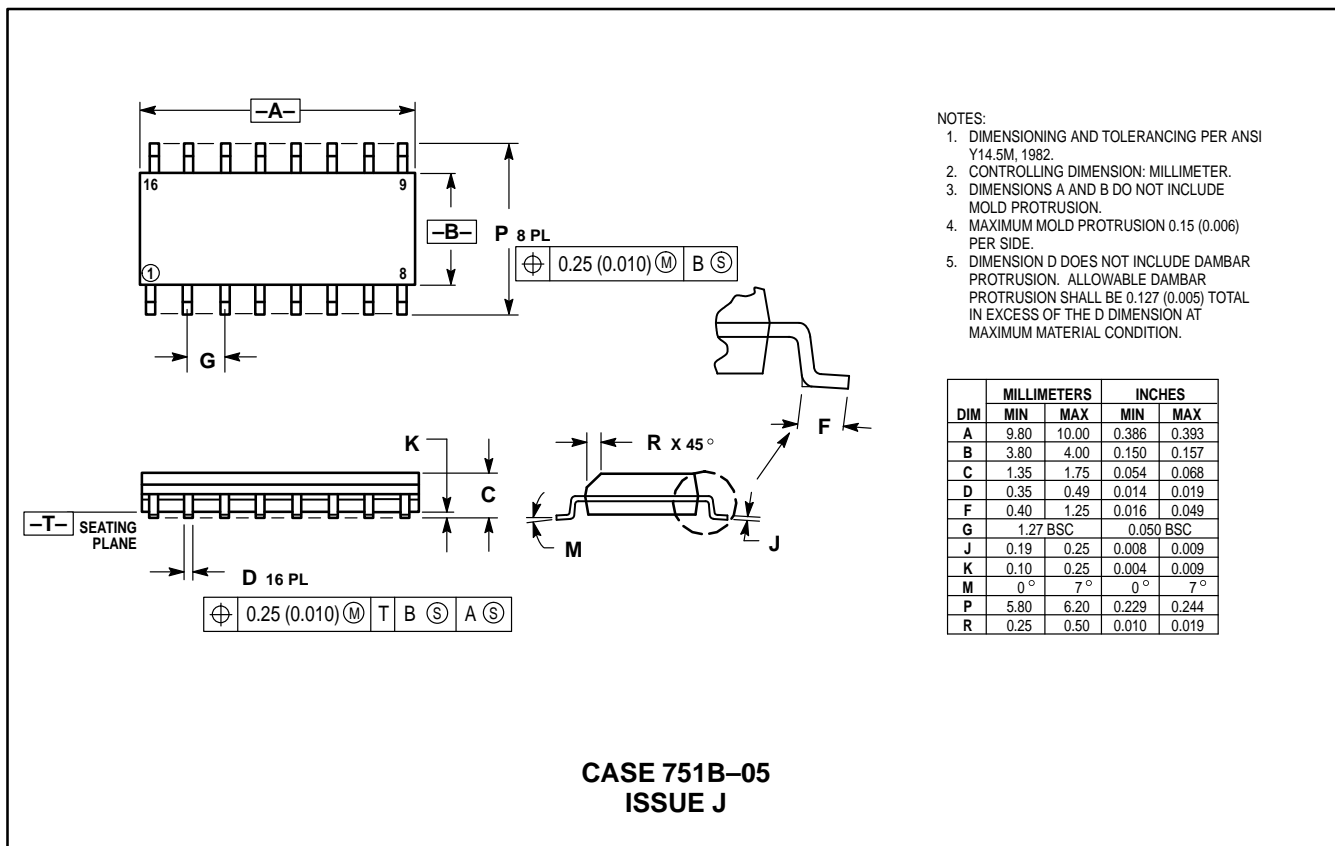

Motorola reserves the right to make changes without further notice to any products herein. Motorola makes no warranty, representation or guarantee regarding the suitability of its products for any particular purpose, nor does Motorola assume any liability arising out of the application or use of any product or circuit, and specifically disclaims any and all liability, including without limitation consequential or incidental damages. "Typical" parameters which may be provided in Motorola data sheets and/or specifications can and do vary in different applications and actual performance may vary over time. All operating parameters, including "Typicals" must be validated for each customer application by customer's technical experts. Motorola does not convey any license under its patent rights nor the rights of others. Motorola products are not designed, intended, or authorized for use as components in systems intended for surgical implant into the body, or other applications intended to support or sustain life, or for any other application in which the failure of the Motorola product could create a situation where personal injury or death may occur. Should Buyer purchase or use Motorola products for any such unintended or unauthorized application, Buyer shall indemnify and hold Motorola and its officers, employees, subsidiaries, affiliates, and distributors harmless against all claims, costs, damages, and expenses, and reasonable attorney fees arising out of, directly or indirectly, any claim of personal injury or death associated with such unintended or unauthorized use, even if such claim alleges that Motorola was negligent regarding the design or manufacture of the part. Motorola and are registered trademarks of Motorola, Inc. Motorola, Inc. is an Equal Opportunity/Affirmative Action Employer.

Mfax is a trademark of Motorola, Inc.

How to reach us:

USA/EUROPE/Locations Not Listed: Motorola Literature Distribution;
P.O. Box 5405, Denver, Colorado 80217. 303-675-2140 or 1-800-441-2447

JAPAN: Nippon Motorola Ltd.: SPD, Strategic Planning Office, 4-32-1,
Nishi-Gotanda, Shinagawa-ku, Tokyo 141, Japan. 81-3-5487-8488

Mfax™: RMFAX0@email.sps.mot.com – TOUCHTONE 602-244-6609
– US & Canada ONLY 1-800-774-1848

ASIA/PACIFIC: Motorola Semiconductors H.K. Ltd.; 8B Tai Ping Industrial Park,
51 Ting Kok Road, Tai Po, N.T., Hong Kong. 852-26629298

INTERNET: <http://motorola.com/spc>

