

The MRFIC Line Broadband GaAs Switch

The MRFIC0903 is an integrated GaAs SPDT switch designed for transceivers operating in the 100 MHz to 2.0 GHz frequency range. The design utilizes Motorola's advanced GaAs RF process to yield superior performance in a cost effective monolithic device. Applications for the MRFIC0903 include Class 4 and 5 GSM, Class 1 and 2 DCS1800, DCS1900, DAMPS, PDC, digital cellular systems as well as analog cellular systems.

- 2.8 W Transmitting Capability through the Transmit Path with a 5.0 Volt Differential Control Signal
- 1.25 W Transmitting Capability through the Transmit Path with a 3.0 Volt Differential Control Signal
- Single Source Operating Supply Voltage
- Low Power Consumption
- Low-Cost, Low Profile Plastic SOIC Package
- Available in Tape and Reel by Adding R2 Suffix.
R2 Suffix = 2,500 Units per Reel.
- Device Marking = M0903

MRFIC0903

ANTENNA SWITCH GaAs MONOLITHIC INTEGRATED CIRCUIT

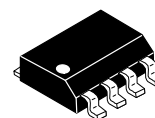

CASE 751-05
(SO-8)

ABSOLUTE MAXIMUM RATINGS ($T_A = 25^\circ\text{C}$ unless otherwise noted)

Rating	Symbol	Value	Unit
Supply Voltage	V_{DD}	10	Vdc
Control Voltage	V_{C1}, V_{C2}	$V_{DD} + 0.8, V_{DD} - 12$	Vdc
Power Dissipation	P_D	1.0	W
Power Input (Non-selected Port)	P_{in}	0.325	W
Ambient Operating Temperature	T_A	-35 to +85	$^\circ\text{C}$
Storage Temperature	T_{stg}	-65 to +150	$^\circ\text{C}$

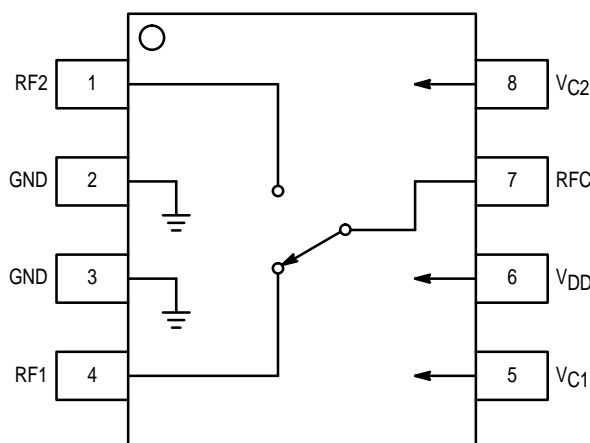

Pin Connections and Functional Block Diagram

RECOMMENDED OPERATING RANGES

Parameter	Symbol	Value	Unit
Supply Voltage	V_{DD}	0 to 5.0	Vdc
Control Voltage Range	V_{C1}, V_{C2}	$V_{DD} - 5.0$ to $V_{DD} + 0.5$	Vdc
RF Frequency Range	f_{RF}	100 to 2000	MHz

ELECTRICAL CHARACTERISTICS ($V_{DD} = 5.0$ V, $P_{in} = 2.5$ W (34 dBm), $f = 900$ MHz, $T_A = 25^\circ\text{C}$ unless otherwise noted)

Characteristic	Min	Typ	Max	Unit
Supply Current				
I_{DD}	—	100	170	μA
$I_{Control}$	—	150	300	μA
VSWR	—	1.5:1	—	
Insertion Loss (RFC/RF1, RFC/RF2)	—	0.55	0.8	dB
Isolation (RFC/RF2, RFC/RF1)	18	20	—	dB
Output Power at 0.1 dB Compression	—	34.5	—	dBm

Electrical Characteristics at 900 MHz measured in test circuit schematic shown in Figure 1 with board losses removed.

ELECTRICAL CHARACTERISTICS ($V_{DD} = 5.0$ V, $P_{in} = 2.0$ W (33 dBm), $f = 1800$ MHz, $T_A = 25^\circ\text{C}$ unless otherwise noted)

Characteristic	Min	Typ	Max	Unit
Supply Current				
I_{DD}	—	100	170	μA
$I_{Control}$	—	150	300	μA
VSWR	—	1.5:1	—	
Insertion Loss (RFC/RF1, RFC/RF2)	—	0.7	0.85	dB
Isolation (RFC/RF2, RFC/RF1)	18	20	—	dB
Output Power at 0.1 dB Compression	—	34	—	dBm

Electrical Characteristics at 1800 MHz measured in test circuit schematic shown in Figure 2 with board losses removed.

V_{C1} and V_{C2} Input Voltage	Min	Typ	Max	Unit
High	V_{DD}	—	$V_{DD} + 0.5$	Vdc
Low	$V_{DD} - 10$	—	$V_{DD} - 5$	Vdc

V_{C1}	V_{C2}	RFC – RF1	RFC – RF2
High	Low	Insertion Loss	Isolation
Low	High	Isolation	Insertion Loss

Table 1. Logic Levels

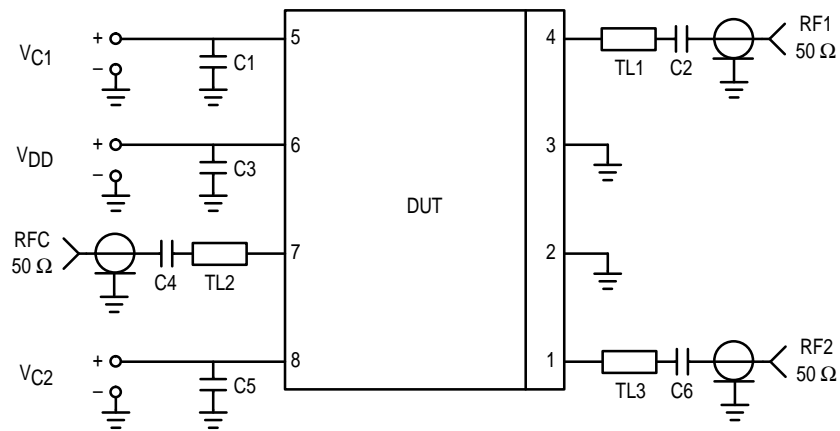

C1, C5 — 2.7 pF, Chip Capacitor
 C2, C4, C6 — 100 pF, Chip Capacitor
 C3 — 10 pF, Chip Capacitor

TL1, TL3 — 12 degrees of 50 Ω line at 1 GHz
 TL2 — 15 degrees of 50 Ω line at 1 GHz

Note: Decoupling capacitors on pins 5, 6 and 8 must be as close as possible to the pins.

Figure 1. 300 MHz to 1600 MHz Test Circuit Configuration

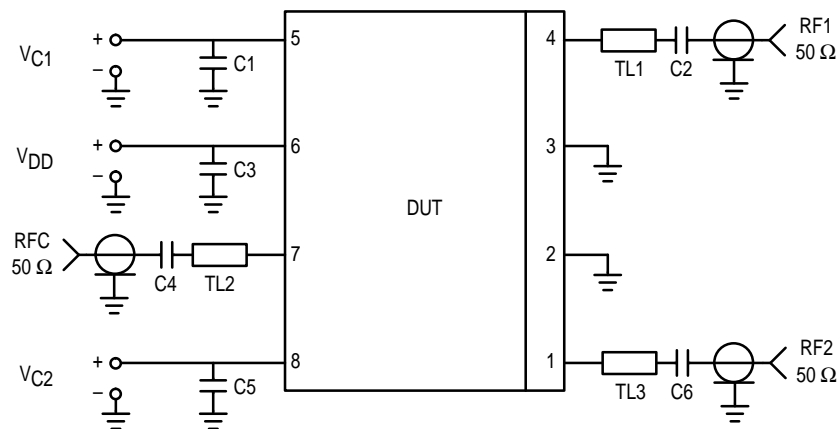

C1, C5 — 1.3 pF, Chip Capacitor
 C2, C3, C4, C6 — 8.2 pF, Chip Capacitor

TL1, TL3 — 12 degrees of 50 Ω line at 1 GHz
 TL2 — 15 degrees of 50 Ω line at 1 GHz

Note: Decoupling capacitors on pins 5, 6 and 8 must be as close as possible to the pins.

Figure 2. 1600 MHz to 2000 MHz Test Circuit Configuration

TYPICAL CHARACTERISTICS

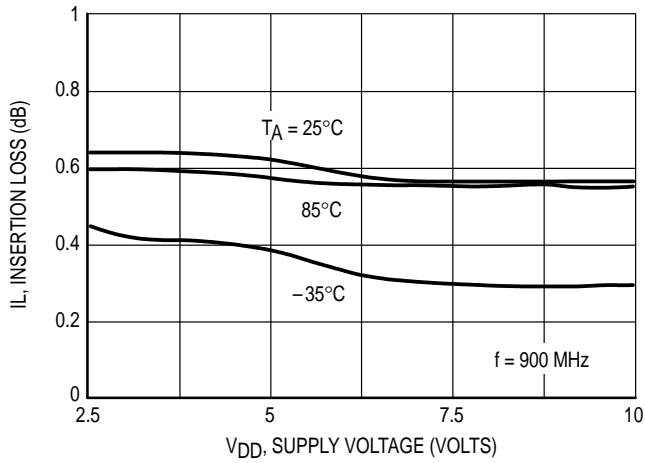

Figure 3. Insertion Loss at 0.1 dB Compression versus Supply Voltage

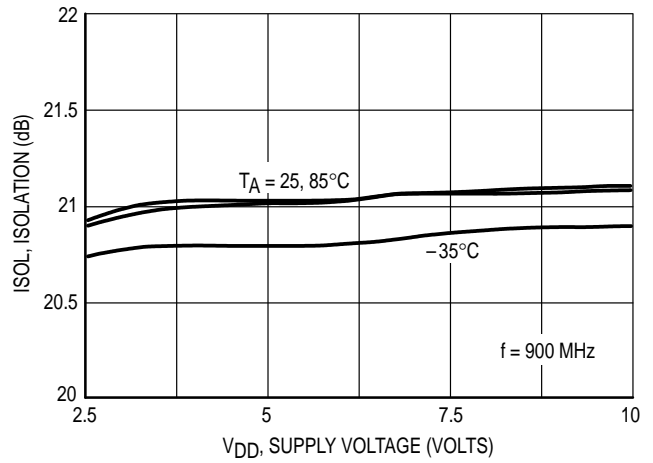

Figure 4. Isolation at 0.1 dB Compression versus Supply Voltage

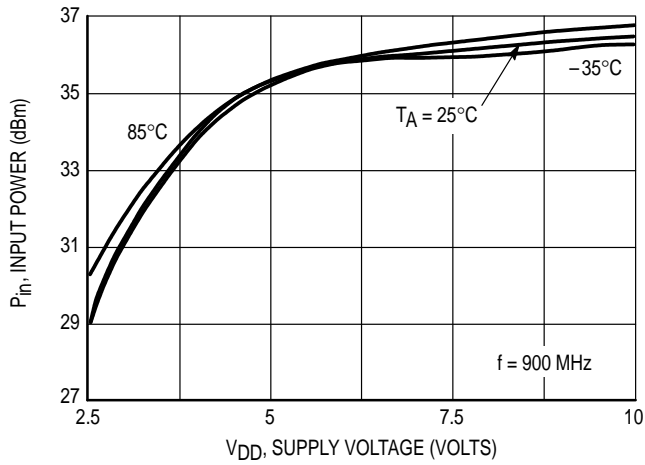

Figure 5. Input Power at 0.1 dB Compression versus Supply Voltage

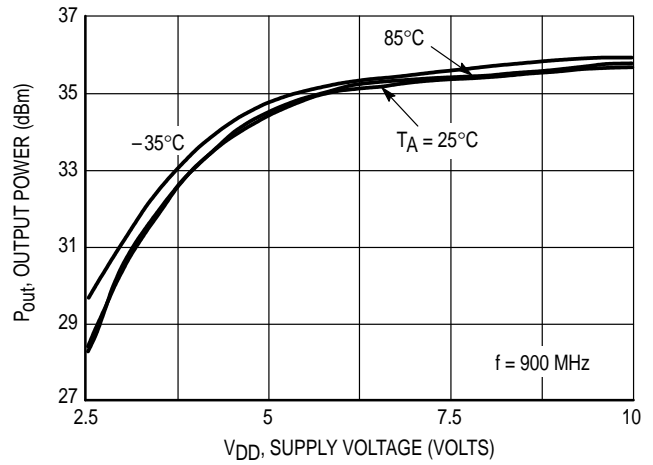

Figure 6. Output Power at 0.1 dB Compression versus Supply Voltage

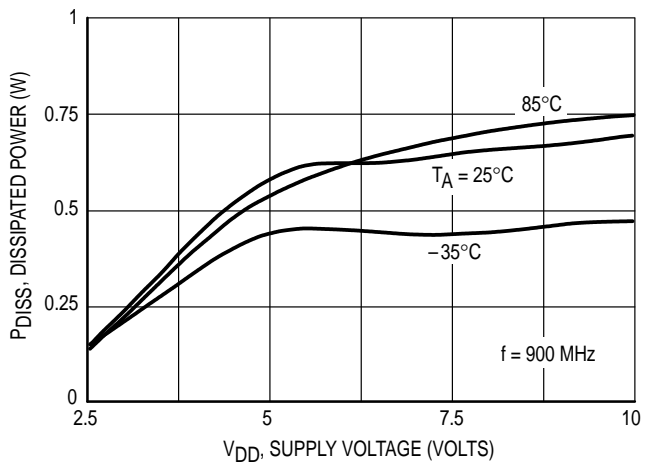

Figure 7. Dissipated Power at 0.1 dB Compression versus Supply Voltage

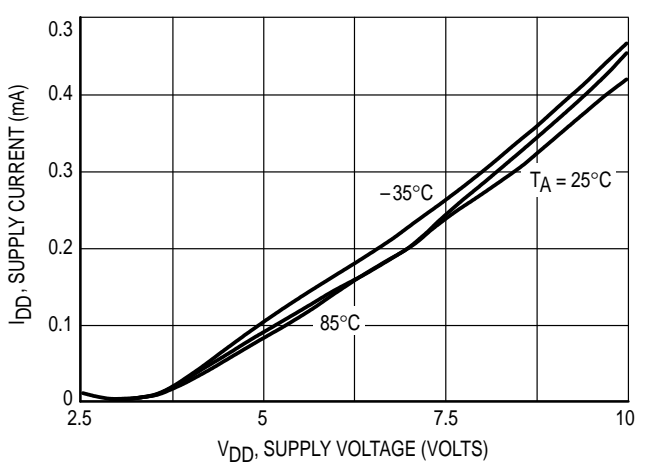

Figure 8. Supply Current at 0.1 dB Compression versus Supply Voltage

TYPICAL CHARACTERISTICS

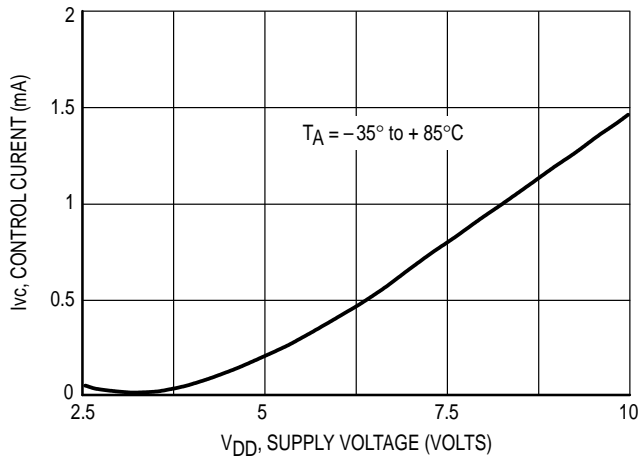

Figure 9. Control Current at Vc Pins at 0.1 dB Compression versus Supply Voltage

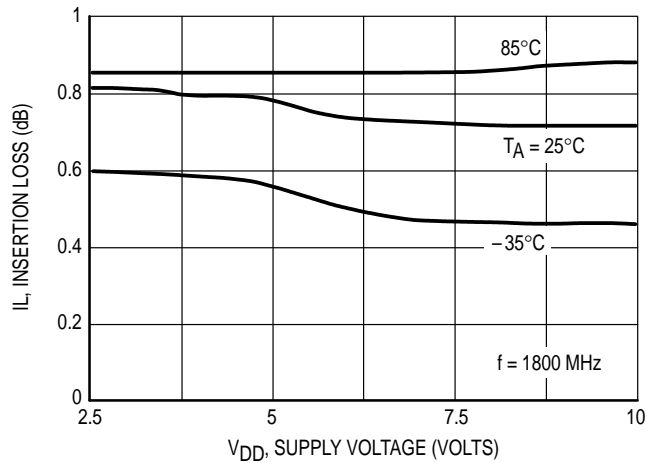

Figure 10. Insertion Loss at 0.1 dB Compression versus Supply Voltage

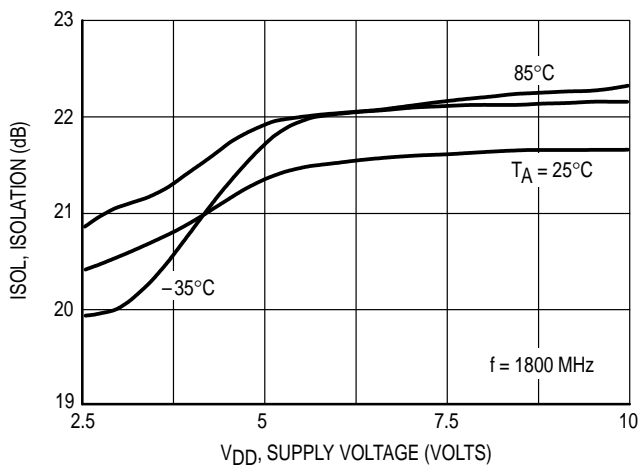

Figure 11. Isolation at 0.1 dB Compression versus Supply Voltage

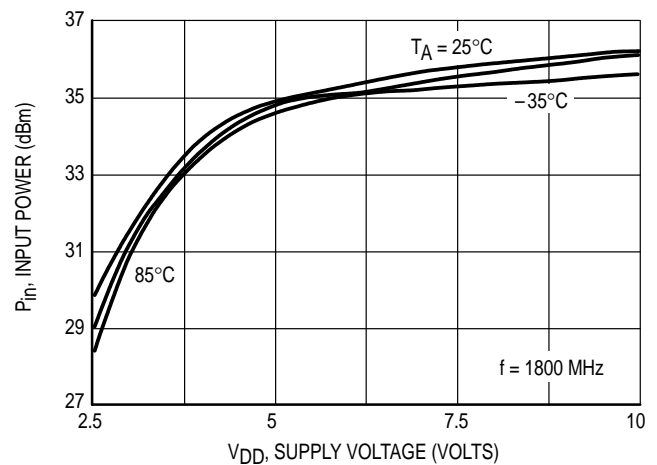

Figure 12. Input Power at 0.1 dB Compression versus Supply Voltage

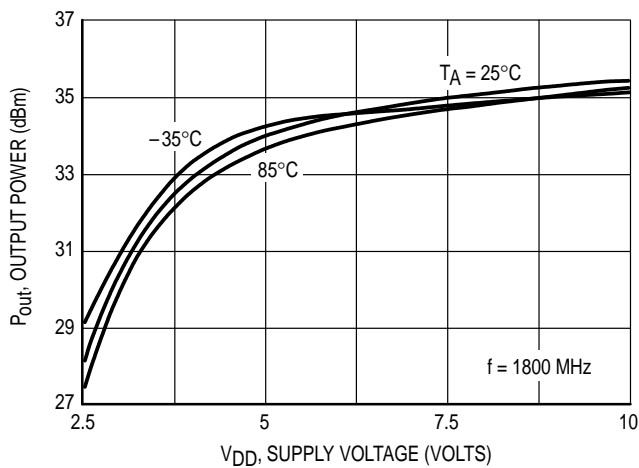

Figure 13. Output Power at 0.1 dB Compression versus Supply Voltage

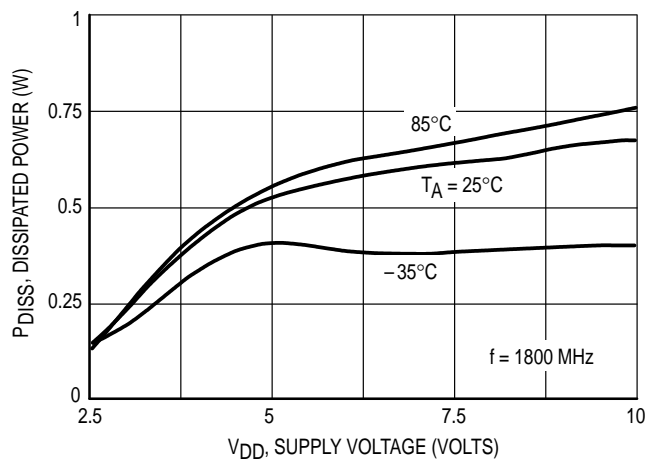

Figure 14. Dissipated Power at 0.1 dB Compression versus Supply Voltage

TYPICAL CHARACTERISTICS

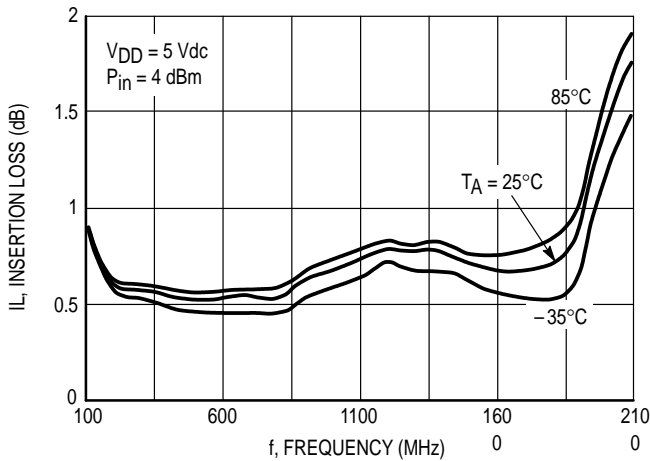

Figure 15. Insertion Loss versus Frequency

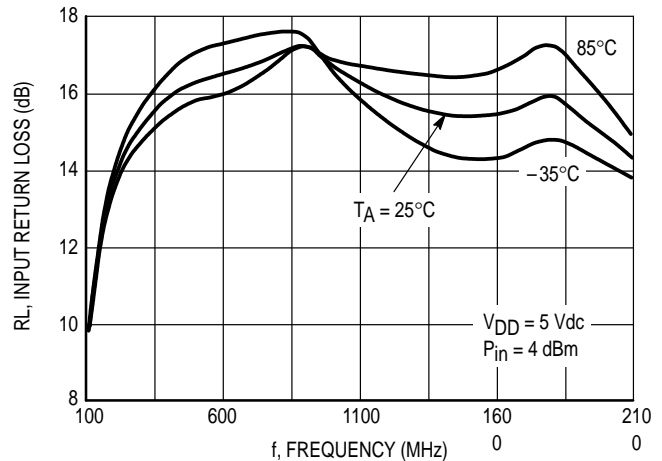

Figure 16. Input Return Loss versus Frequency

APPLICATIONS INFORMATION

DESIGN INFORMATION

The MRFIC0903 SPDT antenna switch was designed for low cost, flexibility and ease of use. This is accomplished by its internal topology that allows control of the switch through its TTL/CMOS compatible (0 to V_{DD}) control pins. Operating on a single positive supply, the switch was designed for a minimum supply voltage, minimum power consumption and low current TTL/CMOS compatible control signals.

THEORY OF OPERATION

The MRFIC0903 can be used as a transmit and receive or antenna diversity switch in the frequency range from 100 MHz to 2 GHz with incident power levels as high as 4 watts.

The frequency behavior can be optimized by resonating the DC blocking capacitor's position and value with the parasitic inductance of the package lead. Operation from 300 MHz to 1.6 GHz can be optimized with a high Q 100 pF blocking capacitor. For the higher frequency band from 1.6 GHz to 2.0 GHz, a 8.2 pF capacitor is suggested. Further improvements can be achieved by resonating the inductance of V_{DD} , V_{C1} , and V_{C2} pins with the appropriate capacitor values.

The power handling capability and linearity of the MRFIC0903 is dependent only on the supply voltage. With a 3 V supply, the device handles 1.25 W (1.6 W PEP) of incident power while maintaining good linearity and low harmonic distortion. The power transmitting capability increases to 3 W of incident power with a 5 V supply and up to 4 W with a 7.5 V supply.

Due to the device's inherently low harmonic distortion, the switch requires little harmonic filtering at its outputs. It also has a high reverse third-order intercept point for use in non-TDMA antenna diversity applications (analog cellular systems).

BIASING CONSIDERATIONS

The MRFIC0903 is based on a floating "cold FET" topology. With this topology, the differential voltage between V_{C1} and V_{C2} dictates the power handling capability. For example, the device's power handling capability is the same with the device biased with 5 V at V_{C1} and 0 V at V_{C2} , with 0 V at V_{C1} and -5 V at V_{C2} , or with 3 V at V_{C1} and -2 V at V_{C2} .

POSSIBLE APPLICATIONS

The MRFIC0903 can be used in a number of cellular and cordless phone applications. The part is applicable for analog cellular phones in systems such as AMPS, TACS, NAMPS, ETACS and NMT900; for digital cellular phones in systems such as GSM, PDC, DAMPS, DCS1800, PCS and NADC; and for cordless phones in systems such as DECT, PHS, ISM, CT1 and CT2. In general it can fit into any application where high power handling capability is required for frequencies ranging from 100 MHz to 2 GHz.

EVALUATION BOARDS

Evaluation boards are available for RF Monolithic Integrated Circuits by adding a "TF" suffix to the device type. For a complete list of currently available boards and ones in development for newly introduced product, please contact your local Motorola Distributor or Sales Office.

PACKAGE DIMENSIONS

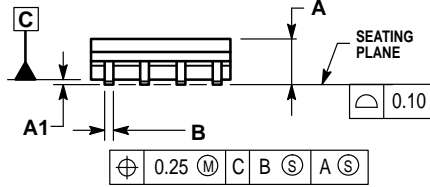
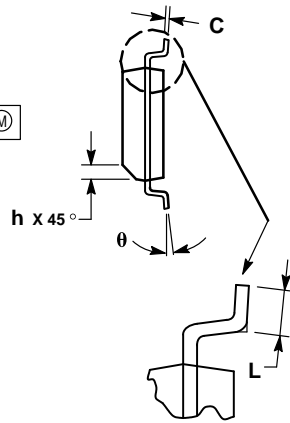
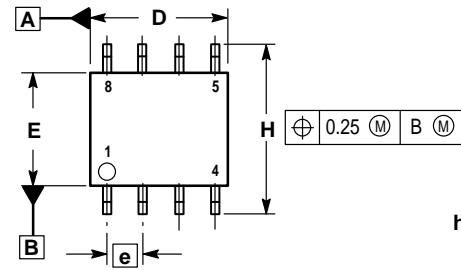

NOTES:

1. DIMENSIONING AND TOLERANCING PER ASME Y14.5M, 1994.
2. DIMENSIONS ARE IN MILLIMETERS.
3. DIMENSION D AND E DO NOT INCLUDE MOLD PROTRUSION.
4. MAXIMUM MOLD PROTRUSION 0.15 PER SIDE.
5. DIMENSION B DOES NOT INCLUDE MOLD PROTRUSION. ALLOWABLE DAMBAR PROTRUSION SHALL BE 0.127 TOTAL IN EXCESS OF THE B DIMENSION AT MAXIMUM MATERIAL CONDITION.

DIM	MILLIMETERS	
	MIN	MAX
A	1.35	1.75
A1	0.10	0.25
B	0.35	0.49
C	0.18	0.25
D	4.80	5.00
E	3.80	4.00
e	1.27 BSC	
H	5.80	6.20
h	0.25	0.50
L	0.40	1.25
θ	0°	7°

**CASE 751-05
ISSUE S**

Motorola reserves the right to make changes without further notice to any products herein. Motorola makes no warranty, representation or guarantee regarding the suitability of its products for any particular purpose, nor does Motorola assume any liability arising out of the application or use of any product or circuit, and specifically disclaims any and all liability, including without limitation consequential or incidental damages. "Typical" parameters which may be provided in Motorola data sheets and/or specifications can and do vary in different applications and actual performance may vary over time. All operating parameters, including "Typicals" must be validated for each customer application by customer's technical experts. Motorola does not convey any license under its patent rights nor the rights of others. Motorola products are not designed, intended, or authorized for use as components in systems intended for surgical implant into the body, or other applications intended to support or sustain life, or for any other application in which the failure of the Motorola product could create a situation where personal injury or death may occur. Should Buyer purchase or use Motorola products for any such unintended or unauthorized application, Buyer shall indemnify and hold Motorola and its officers, employees, subsidiaries, affiliates, and distributors harmless against all claims, costs, damages, and expenses, and reasonable attorney fees arising out of, directly or indirectly, any claim of personal injury or death associated with such unintended or unauthorized use, even if such claim alleges that Motorola was negligent regarding the design or manufacture of the part. Motorola and  are registered trademarks of Motorola, Inc. Motorola, Inc. is an Equal Opportunity/Affirmative Action Employer.

Mfax is a trademark of Motorola, Inc.

How to reach us:

USA/EUROPE/Locations Not Listed: Motorola Literature Distribution;
P.O. Box 5405, Denver, Colorado 80217. 303-675-2140 or 1-800-441-2447

JAPAN: Nippon Motorola Ltd.: SPD, Strategic Planning Office, 4-32-1,
Nishi-Gotanda, Shinagawa-ku, Tokyo 141, Japan. 81-3-5487-8488

Mfax™: RMFAX0@email.sps.mot.com – TOUCHTONE 602-244-6609
– US & Canada ONLY 1-800-774-1848

ASIA/PACIFIC: Motorola Semiconductors H.K. Ltd.; 8B Tai Ping Industrial Park,
51 Ting Kok Road, Tai Po, N.T., Hong Kong. 852-26629298

INTERNET: <http://motorola.com/sps>



MRFIC0903/D