

FEATURES

- Dual Device Module
- Electrically Isolated Package
- Pressure Contact Construction
- International Standard Footprint
- Alumina (Non Toxic) Isolation Medium
- Integral Water Cooled Heatsink

APPLICATIONS

- Motor Control
- Controlled Rectifier Bridges
- Heater Control
- AC Phase Control

VOLTAGE RATINGS

Type Number	Repetitive Peak Voltages V_{DRM} V_{RRM}	Conditions
MP04TT500-28	2800	$T_{vj} = 0^\circ \text{ to } 125^\circ \text{C}$, $I_{DRM} = I_{RRM} = 50\text{mA}$ $V_{DSM} = V_{RSM} =$ $V_{DRM} = V_{RRM} + 100\text{V}$ respectively
MP04TT500-27	2700	
MP04TT500-26	2600	
MP04TT500-25	2500	

Lower voltage grades available

ORDERING INFORMATION

Order As:

MP04TT500-XX-W2	1/4 - 18 NPT connection
MP04TT500-XX-W3	1/4 - 18 NPT connection
MP04TT500-XX-W3A	1/4 - 18 NPT water connection thread

XX shown in the part number about represents $V_{DRM}/100$ selection required, eg. MP04TT500-27-W2

Note: When ordering, please use the complete part number.

KEY PARAMETERS

V_{DRM}	2800V
$I_{T(AV)}$ (per arm)	480A
I_{TSM} (per arm)	11200A
$I_{T(RMS)}$ (per arm)	753A
V_{isol}	3000V

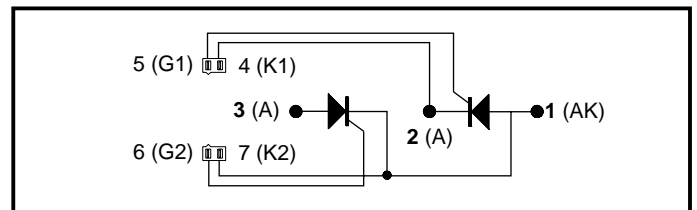

Fig. 1 TT Circuit diagram

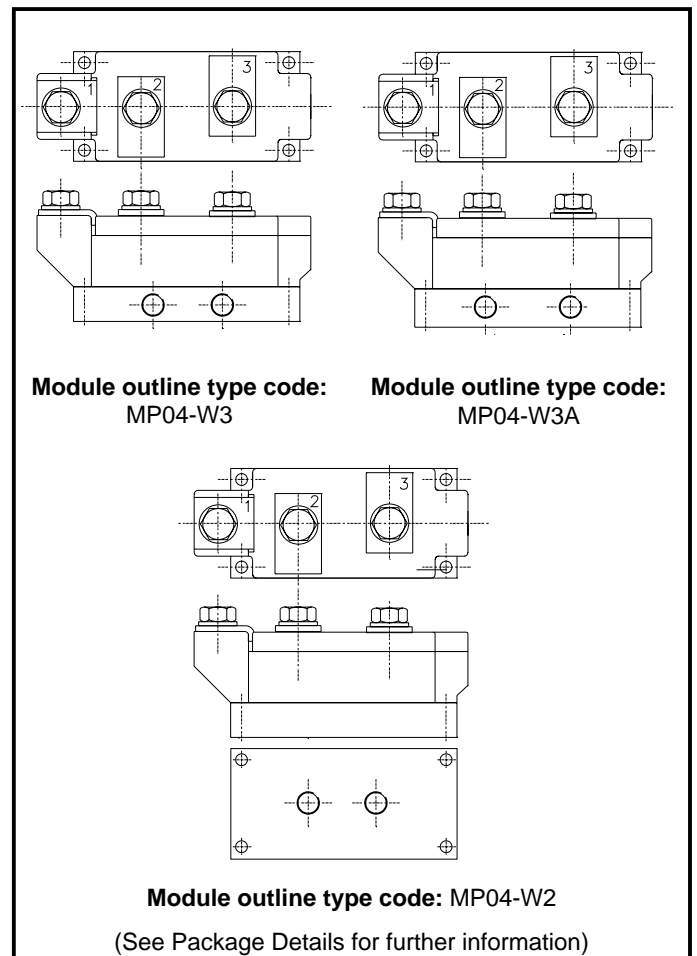

Fig. 2 Module package variants - (not to scale)

ABSOLUTE MAXIMUM RATINGS - PER ARM

Stresses above those listed under 'Absolute Maximum Ratings' may cause permanent damage to the device. In extreme conditions, as with all semiconductors, this may include potentially hazardous rupture of the package. Appropriate safety precautions should always be followed. Exposure to Absolute Maximum Ratings may affect device reliability.

Symbol	Parameter	Test Conditions	Max.	Units	
$I_{T(AV)}$	Mean on-state current	Half wave resistive load, 4.5 Ltr/min	$T_{water (in)} = 25^{\circ}C$	540	A
			$T_{water (in)} = 40^{\circ}C$	480	A
$I_{T(RMS)}$	RMS value	$T_{water (in)} = 25^{\circ}C @ 4.5 \text{ Ltr/min}$		845	A
		$T_{water (in)} = 40^{\circ}C @ 4.5 \text{ Ltr/min}$		753	A
I_{TSM}	Surge (non-repetitive) on-current	10ms half sine, $T_j = 125^{\circ}C$		11.25	kA
I^2t	I^2t for fusing	$V_R = 0$		633×10^3	A^2s
I_{TSM}	Surge (non-repetitive) on-current	10ms half sine, $T_j = 125^{\circ}C$		9	kA
I^2t	I^2t for fusing	$V_R = 50\% V_{DRM}$		506×10^3	A^2s
V_{isol}	Isolation voltage	Commoned terminals to base plate. AC RMS, 1 min, 50Hz		3000	V

THERMAL AND MECHANICAL RATINGS

Symbol	Parameter	Test Conditions	Min.	Max.	Units
$R_{th(j-w)}$	Thermal resistance - junction to water (per thyristor)	dc, 4.5 Ltr/min	-	0.102	$^{\circ}C/kW$
		Half wave, 4.5 Ltr/min	-	0.106	$^{\circ}C/kW$
		3 Phase, 4.5 Ltr/min	-	0.112	$^{\circ}C/kW$
T_{vj}	Virtual junction temperature	Reverse (blocking)	-	125	$^{\circ}C$
T_{stg}	Storage temperature range	-	-40	125	$^{\circ}C$
-	Screw torque	Mounting - M6	6 (53)	-	Nm (lb.ins)
		Electrical connections - M10	-	12 (106)	Nm (lb.ins)

DYNAMIC CHARACTERISTICS

Symbol	Parameter	Test Conditions	Min.	Max.	Units
I_{RRM}/I_{DRM}	Peak reverse and off-state current	At V_{RRM}/V_{DRM} , $T_j = 125^\circ\text{C}$	-	50	mA
dV/dt	Linear rate of rise of off-state voltage	To 67% V_{DRM} , $T_j = 125^\circ\text{C}$	-	1000	V/ μs
dI/dt	Rate of rise of on-state current	From 67% V_{DRM} to 500A, gate source 10V, 5 Ω $t_r = 0.5\mu\text{s}$, $T_j = 125^\circ\text{C}$	-	500	A/ μs
$V_{T(TO)}$	Threshold voltage. (See note 1)	At $T_{vj} = 125^\circ\text{C}$	-	0.91	V
r_T	On-state slope resistance. (See note 1)	At $T_{vj} = 125^\circ\text{C}$	-	0.65	m Ω

Note 1: The data given in this datasheet with regard to forward voltage drop is for calculation of the power dissipation in the semiconductor elements only. Forward voltage drops measured at the power terminals of the module will be in excess of these figures due to the impedance of the busbar from the terminal to the semiconductor.

GATE TRIGGER CHARACTERISTICS AND RATINGS

Symbol	Parameter	Test Conditions	Max.	Units
V_{GT}	Gate trigger voltage	$V_{DRM} = 5\text{V}$, $T_{case} = 25^\circ\text{C}$	3.5	V
I_{GT}	Gate trigger current	$V_{DRM} = 5\text{V}$, $T_{case} = 25^\circ\text{C}$	200	mA
V_{GD}	Gate non-trigger voltage	At V_{DRM} , $T_{case} = 125^\circ\text{C}$	0.25	V
V_{FGM}	Peak forward gate voltage	Anode positive with respect to cathode	30	V
V_{FGN}	Peak forward gate voltage	Anode negative with respect to cathode	0.25	V
V_{RGM}	Peak reverse gate voltage	-	5	V
I_{FGM}	Peak forward gate current	Anode positive with respect to cathode	10	A
P_{GM}	Peak gate power	See table fig. 5	150	W
$P_{G(AV)}$	Mean gate power	-	10	W

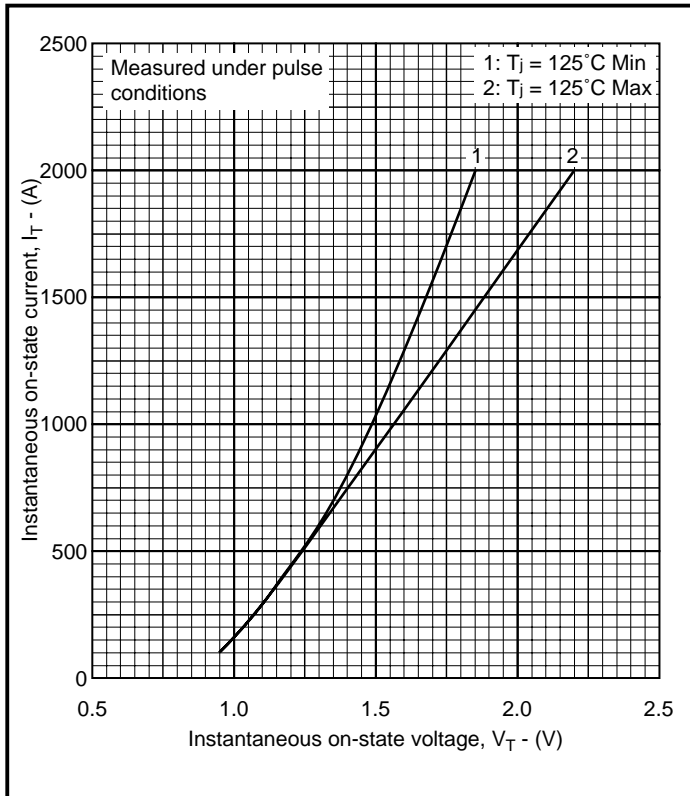

Fig. 3 Maximum (limit) on-state characteristics

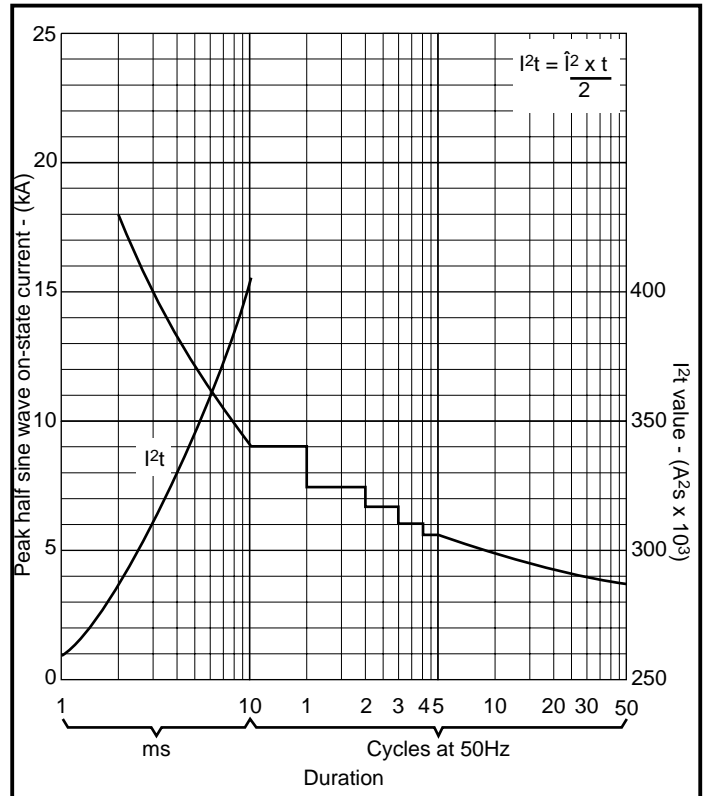

Fig. 4 Surge (non-repetitive) on-state current vs time (with 50% V_{RSM} at $T_{case} = 125^\circ\text{C}$)

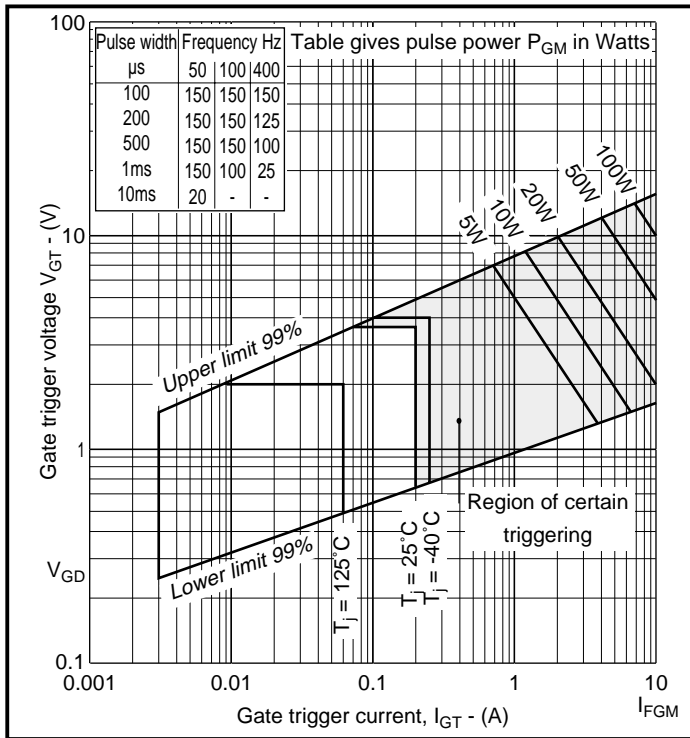

Fig. 5 Gate characteristics

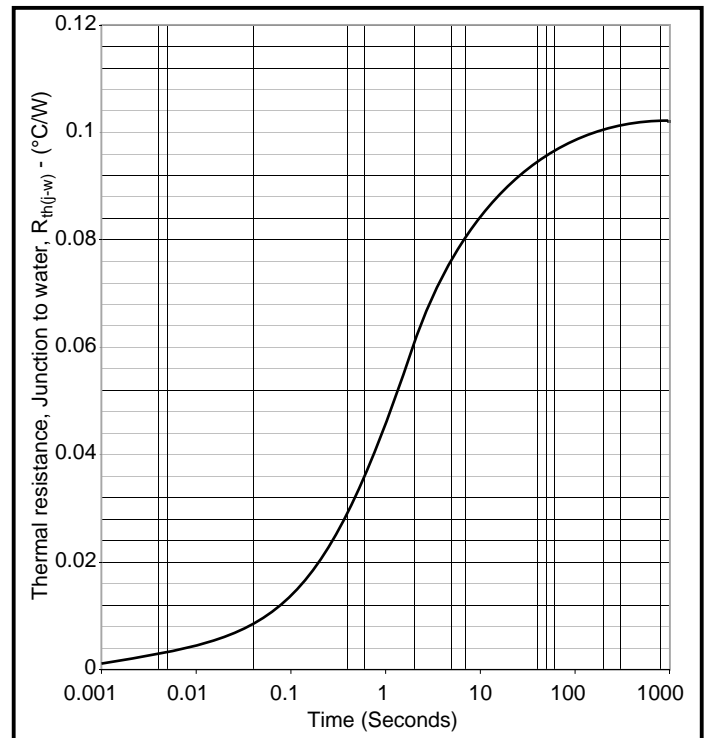

Fig. 6 Transient thermal impedance - dc

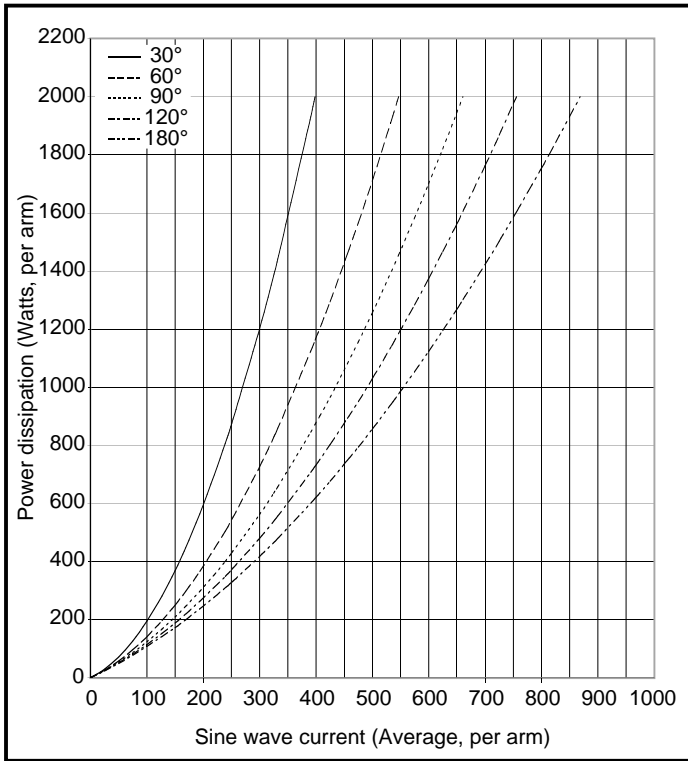

Fig. 7 On-state power loss per arm vs on-state current at specified conduction angles, sine wave 50/60Hz

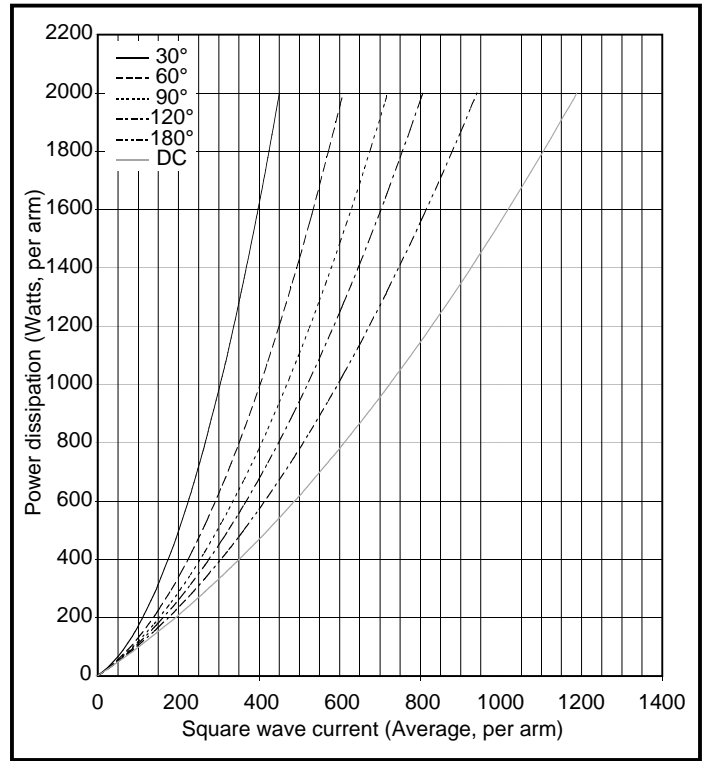

Fig. 8 On-state power loss per arm vs on-state current at specified conduction angles, square wave 50/60Hz

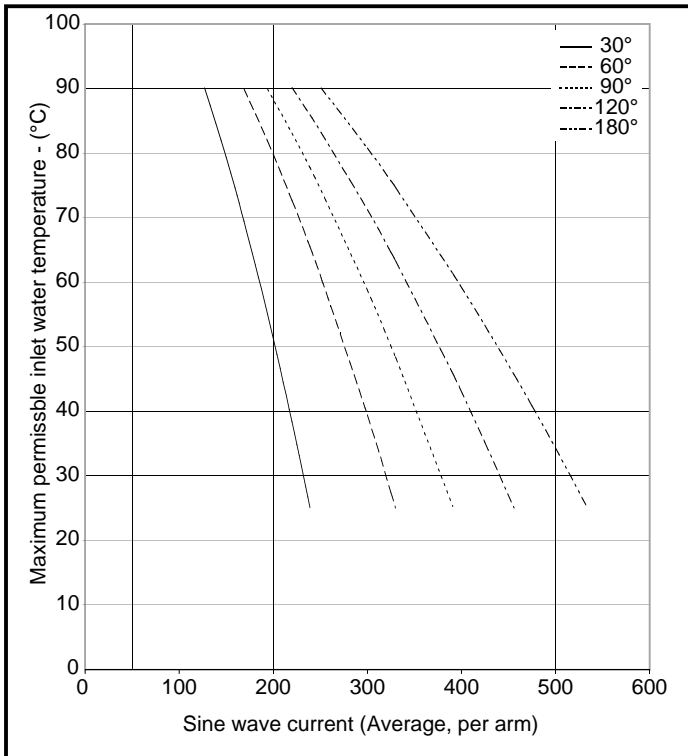

Fig. 9 Maximum permissible water inlet temperature vs on-state current at specified conduction angles, sine wave 50/60Hz

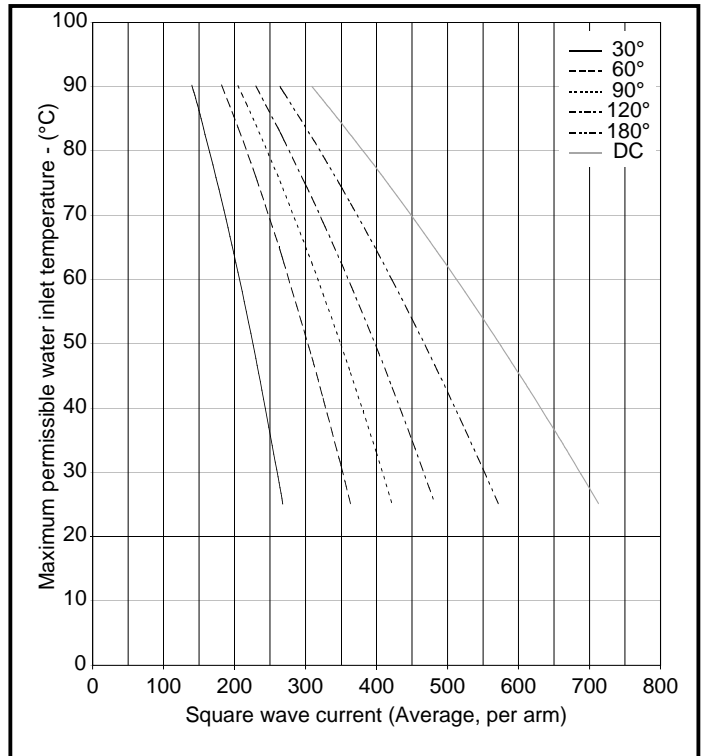

Fig. 10 Maximum permissible water inlet temperature vs on-state current at specified conduction angles, square wave 50/60Hz

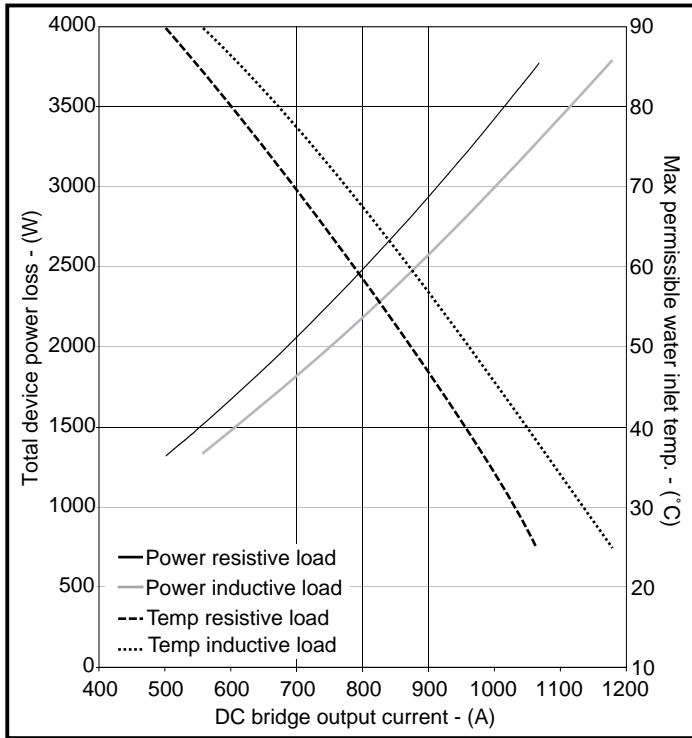

Fig. 11 50/60Hz single phase bridge DC output current vs power loss and maximum permissible water inlet

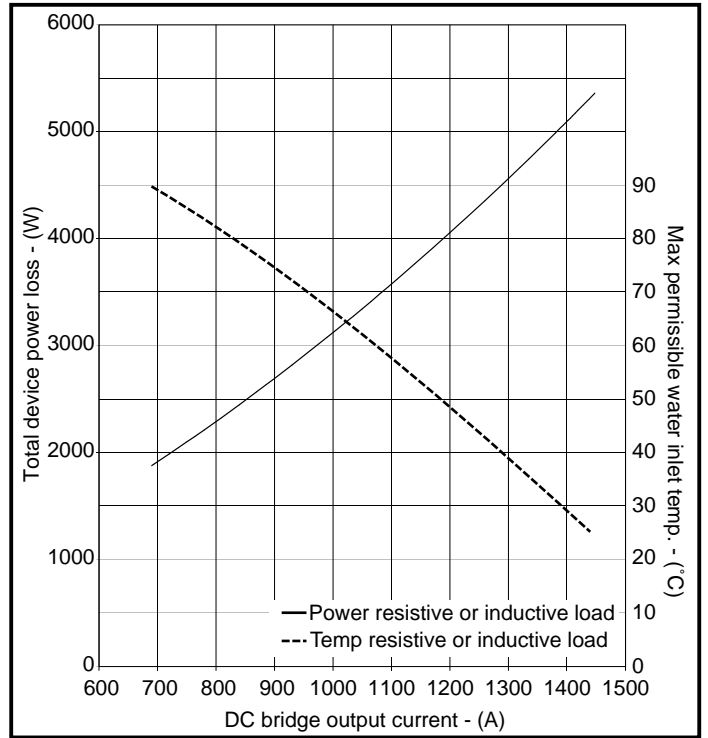
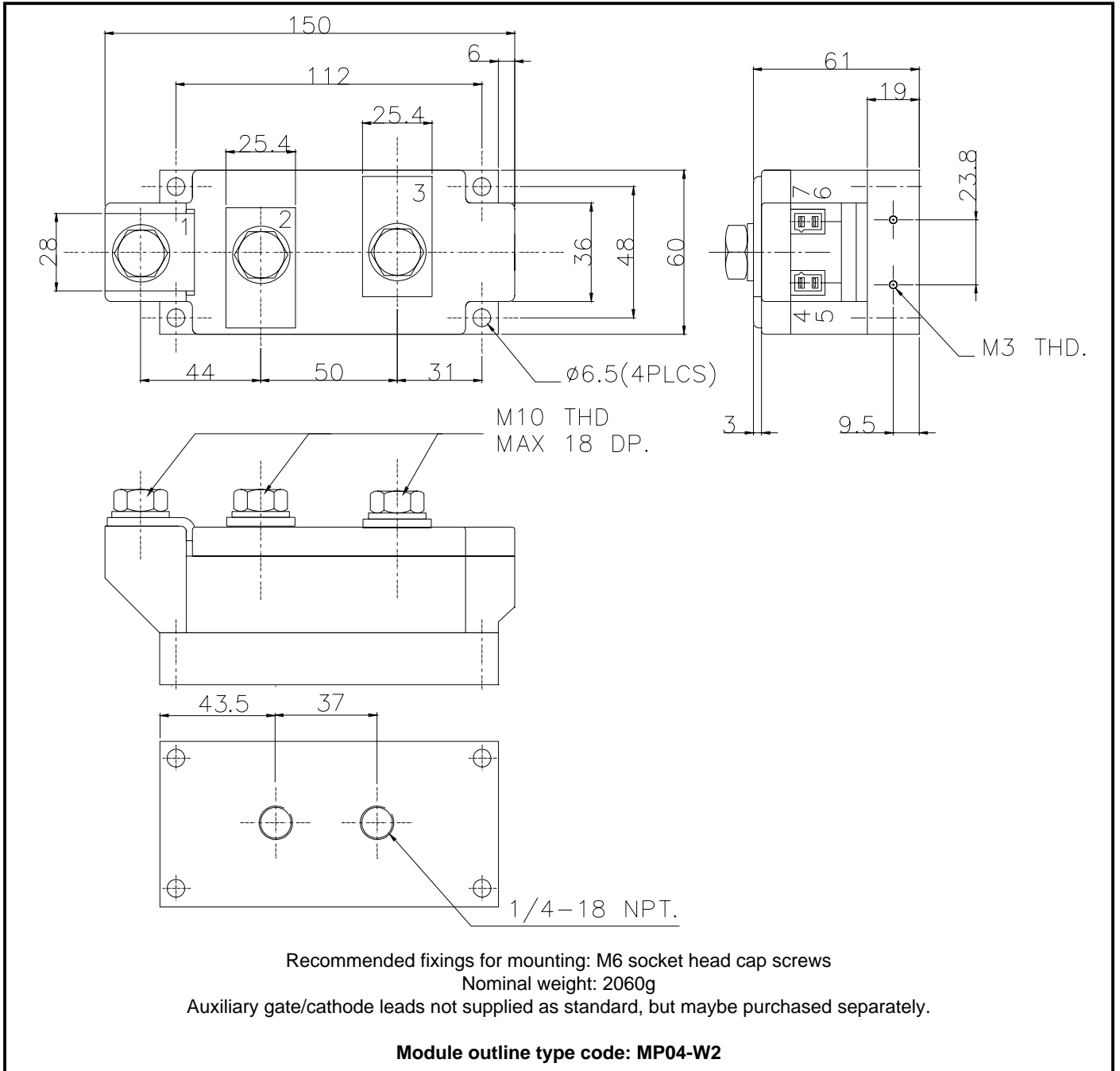

Fig. 12 50/60Hz three phase bridge DC output current vs power loss and maximum permissible water inlet

PACKAGE DETAILS

For further package information, please visit our website or contact your nearest Customer Service Centre. All dimensions in mm, unless stated otherwise. DO NOT SCALE.



PACKAGE DETAILS

For further package information, please visit our website or contact your nearest Customer Service Centre. All dimensions in mm, unless stated otherwise. DO NOT SCALE.

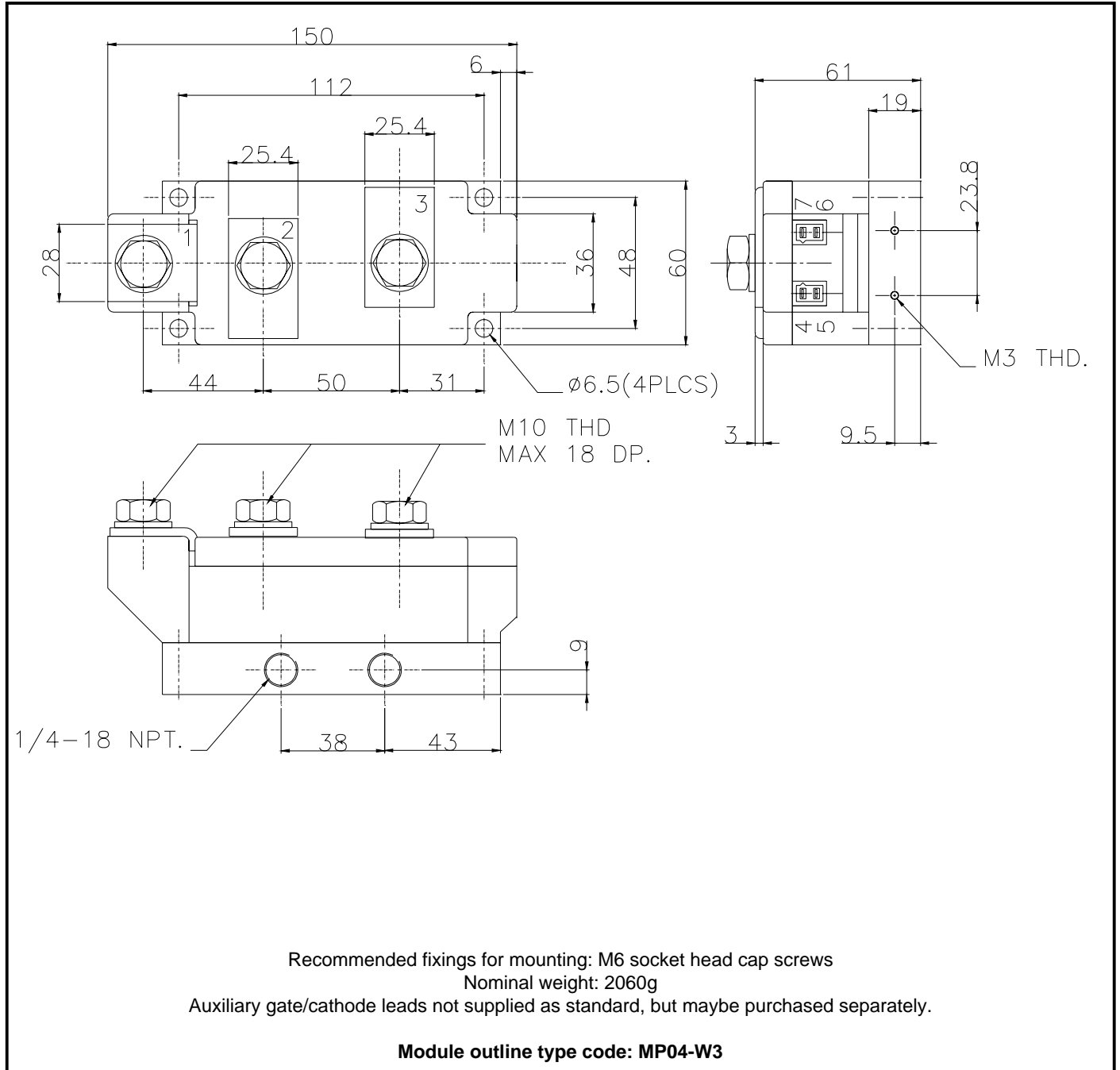

Recommended fixings for mounting: M6 socket head cap screws

Nominal weight: 2060g

Auxiliary gate/cathode leads not supplied as standard, but maybe purchased separately.

Module outline type code: MP04-W3

PACKAGE DETAILS

For further package information, please visit our website or contact your nearest Customer Service Centre. All dimensions in mm, unless stated otherwise. DO NOT SCALE.

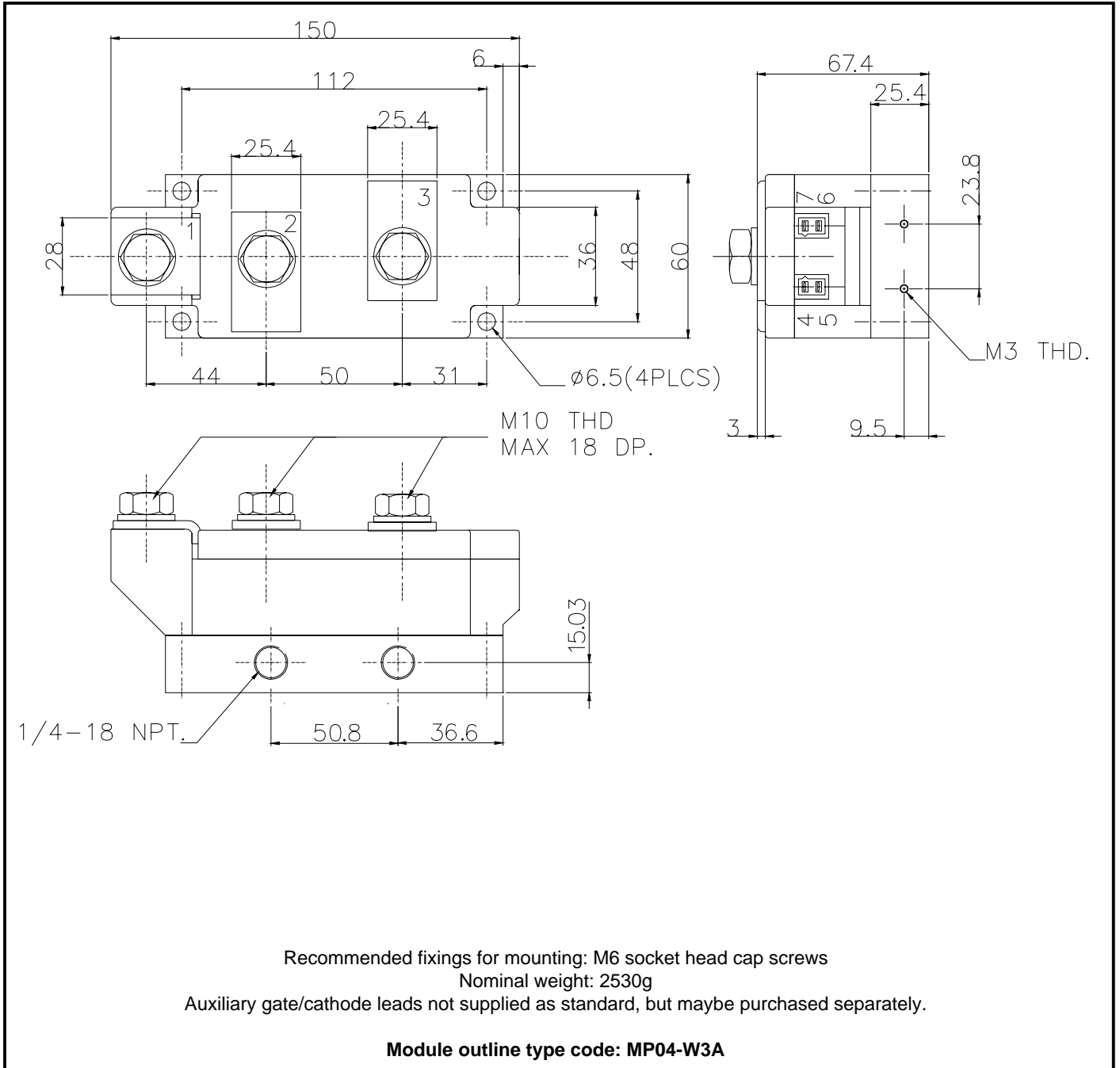

POWER ASSEMBLY CAPABILITY

The Power Assembly group provides support for those customers requiring more than the basic semiconductor switch. Using CAD design tools the group has developed a flexible range of heatsink / clamping systems in line with advances in device types and the voltage and current capability of Dynex semiconductors.

An extensive range of air and liquid cooled assemblies is available covering the range of circuit designs in general use today.

HEATSINKS

The Power Assembly group has a proprietary range of extruded aluminium heatsinks. These were designed to optimise the performance of Dynex semiconductors. Data with respect to air natural, forced air and liquid cooling (with flow rates) is available on request.

For further information on device clamps, heatsinks and assemblies, please contact your nearest sales representative or customer service office.



<http://www.dynexsemi.com>

e-mail: power_solutions@dynexsemi.com

HEADQUARTERS OPERATIONS
DYNEX SEMICONDUCTOR LTD
 Doddington Road, Lincoln.
 Lincolnshire. LN6 3LF. United Kingdom.
 Tel: 00-44-(0)1522-500500
 Fax: 00-44-(0)1522-500550

DYNEX POWER INC.
 99 Bank Street, Suite 410,
 Ottawa, Ontario, Canada, K1P 6B9
 Tel: 613.723.7035
 Fax: 613.723.1518
 Toll Free: 1.888.33.DYNEX (39639)

CUSTOMER SERVICE CENTRES
Mainland Europe Tel: +33 (0)1 58 04 91 00. Fax: +33 (0)1 46 38 51 33
North America Tel: 011-800-5554-5554. Fax: 011-800-5444-5444
UK, Scandinavia & Rest Of World Tel: +44 (0)1522 500500. Fax: +44 (0)1522 500020

SALES OFFICES
Mainland Europe Tel: +33 (0)1 58 04 91 00. Fax: +33 (0)1 46 38 51 33
North America Tel: (613) 723-7035. Fax: (613) 723-1518. Toll Free: 1.888.33.DYNEX (39639) /
 Tel: (949) 733-3005. Fax: (949) 733-2986.
UK, Scandinavia & Rest Of World Tel: +44 (0)1522 500500. Fax: +44 (0)1522 500020

These offices are supported by Representatives and Distributors in many countries world-wide.
 © Dynex Semiconductor 2001 Publication No. DS5446-1 Issue No. 1.2 May 2001
 TECHNICAL DOCUMENTATION – NOT FOR RESALE. PRINTED IN UNITED KINGDOM

Datasheet Annotations:

Dynex Semiconductor annotate datasheets in the top right hand corner of the front page, to indicate product status. The annotations are as follows:-

Target Information: This is the most tentative form of information and represents a very preliminary specification. No actual design work on the product has been started.

Preliminary Information: The product is in design and development. The datasheet represents the product as it is understood but details may change.

Advance Information: The product design is complete and final characterisation for volume production is well in hand.

No Annotation: The product parameters are fixed and the product is available to datasheet specification.

This publication is issued to provide information only which (unless agreed by the Company in writing) may not be used, applied or reproduced for any purpose nor form part of any order or contract nor to be regarded as a representation relating to the products or services concerned. No warranty or guarantee express or implied is made regarding the capability, performance or suitability of any product or service. The Company reserves the right to alter without prior notice the specification, design or price of any product or service. Information concerning possible methods of use is provided as a guide only and does not constitute any guarantee that such methods of use will be satisfactory in a specific piece of equipment. It is the user's responsibility to fully determine the performance and suitability of any equipment using such information and to ensure that any publication or data used is up to date and has not been superseded. These products are not suitable for use in any medical products whose failure to perform may result in significant injury or death to the user. All products and materials are sold and services provided subject to the Company's conditions of sale, which are available on request.

All brand names and product names used in this publication are trademarks, registered trademarks or trade names of their respective owners.