

IC for Headphone Stereos

Monolithic IC MM1104

Outline

This IC was developed for use in 3 V headphone stereos. It incorporates all the basic functions of tape players.

Mitsumi has previously offered the LAG665, LAG668, LAG673 and MM1006 as one-chip versions. However, this IC is the result of a through review and redesign extending to circuit details.

Features

1. Configuration: Pre-and power amp, motor control
2. Adoption of shock noise prevention circuitry
Through the use of a circuit which suppresses noise occurring when the power supply is turned on and off, noise output is reduced without muting.
3. Stable motor speed control circuit
A bridge circuit employing power transistors provides motor speed control with minimal drift.
4. Preamp off pin is convenient for radio connections
5. Radiation pin: When radio wave-induced noise is a problem, this pin can be used to cut the frequency characteristic.

Package

SOP-28B (MM1104AF, MM1104BF, MM1104CF)

Pin Assignment

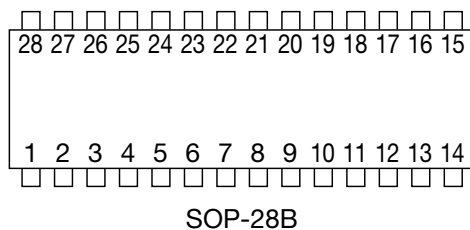

1	1/2V _{CC}	15	N.C
2	PreIN1	16	Speed
3	NFB1	17	Phase
4	PreOUT1	18	V _s
5	Pre Off	19	PowerOUT2
6	PowerIN1	20	Amp V _{CC}
7	Radiation1	21	Filter
8	PowerOUT1	22	Radiation2
9	GND	23	PowerIN2
10	Governor V _{CC}	24	N.C
11	N.C	25	PreOUT2
12	PCOUT	26	NFB2
13	GND	27	PreIN2
14	Governor GND	28	Amp GND

Absolute Maximum Ratings

Item	Symbol	Ratings	Units
Operating temperature	T _{OPR}	-20~+65	°C
Storage temperature	T _{STG}	-40~+125	°C
Power supply current	V _{CC}	-0.3~+7.5	V
Power consumption	P _d	700 (Ta=25°C)	mW
Operating voltage	V _{OP}	+2.0~+5.0	V

Electrical Characteristics (Except where noted otherwise, Ta=25°C)

Item	Symbol	Measurement conditions	Min.	Typ.	Max.	Units
Consumption current	I _{CC}	Amp. only		11	18	mA
Preamp unit (Ta=25°C)						
Open-circuit gain	G _{Vo}	V _O =-10dBm f=100Hz		86		dB
Closed-circuit gain	G _{Vc}	V _O =-10dBm		42		dB
Maximum output voltage	V _{om}	THD=10%	0.5	0.74		V _{rms}
Total harmonic distortion ratio	THD	V _O =-10dBm		0.06	0.5	%
Output noise voltage	V _{no}	R _g =2.2kΩ, CCIR waiting		240	500	μV _{rms}
Crosstalk between channels	CH _{CT}	V _O =-10dBm	45	60		dB
Ripple rejection	RR	V _{CC} =3V, V _R =-20dBm, f _R =100Hz	30	42		dB
Output voltage with preamp off	V _{oOff}	V _O =-10dBm, when pre operation		-100	-70	dBm
Input resistance with preamp off	R _{iOff}		7	10	13	kΩ
Output resistance with preamp off	R _{oOff}		7	10	13	kΩ
Measurement conditions: Except where noted otherwise, V _{CC} =3V, R _g =2.2kΩ, R _L =30kΩ, f=1kHz						
Power amp unit (Ta=25°C)						
Input resistance	R _i		14	20	26	kΩ
Voltage gain	G _v	P _o =5mW	32	34	36	dB
Voltage gain difference between channels	ΔG _v			0	2	dB
Maximum output power I	P _{om1}	THD=10%, R _L =16Ω	40	62		mW
Maximum output power II	P _{om2}	THD=10%, R _L =32Ω	20	34		mW
Total harmonic distortion ratio	THD	P _o =5mW		0.4	2	%
Crosstalk between channels	CH _{CT}	P _o =5mW	45	62		dB
Output noise voltage	V _n	R _g =1kΩ, CCIR waiting		150	300	μV _{rms}
Ripple rejection	RR	V _{CC} =3V, V _R =-20dBm, f _R =100Hz	40	50		dB
Measurement conditions: Except where noted otherwise, V _{CC} =3V, R _g =1kΩ, R _L =16Ω, f=1kHz						
Motor governor (Ta=25°C)						
Consumption current	I _d	A ₂ measured		2.0	7.0	mA
Startup current	I _{MS}	I _M measured when R _V =1.5Ω	500			mA
Reference voltage	V _{ref}	V ₅ measured with SW12 off	0.09	0.10	0.11	V
Reference voltage fluctuation I	ΔV _{ref1}	V _S fluctuation for V _{CC} =1.5 to 3.5V, V _{CC} =3.0V ref.		0.1	0.5	%/V
Reference voltage fluctuation II	ΔV _{ref2}	V _S fluctuation for I _M =25 to 200mA, I _M =100mA ref.		0.005	0.05	%/mA
Reference voltage fluctuation III	ΔV _{ref3}	V _S fluctuation for T _a =-10 to 60°C, T _a =25°C ref.		0.01		%/°C
Output saturation voltage	V _{oSAT}	Reference voltage V ₈ measured I _M =200mA with SW12 on		0.2	0.3	V
Bridge ratio	K	V ₇ /V ₆ measured	9	10	11	

Item	Symbol	Measurement conditions	Min.	Typ.	Max.	Units
Bridge ratio fluctuation I	$\Delta K1$	K fluctuation for $V_{CC}=1.5$ to $3.5V$, $V_{CC}=3.0V$ ref.		0.1	0.2	%/V
Bridge ratio fluctuation II	$\Delta K2$	K fluctuation for $I_M=25$ to $200mA$, $I_M=100mA$ ref.		0.05	0.2	%/mA
Bridge ratio fluctuation III	$\Delta K3$	K fluctuation for $T_a=-10$ to $60^\circ C$, $T_a=25^\circ C$ ref.		0.01		%/°C

Measurement conditions: Except where noted otherwise, $V_{CC}=3V$, $I_M=100mA$, SW11=OFF, SW12=ON

Block Diagram (Example of Application Circuits)

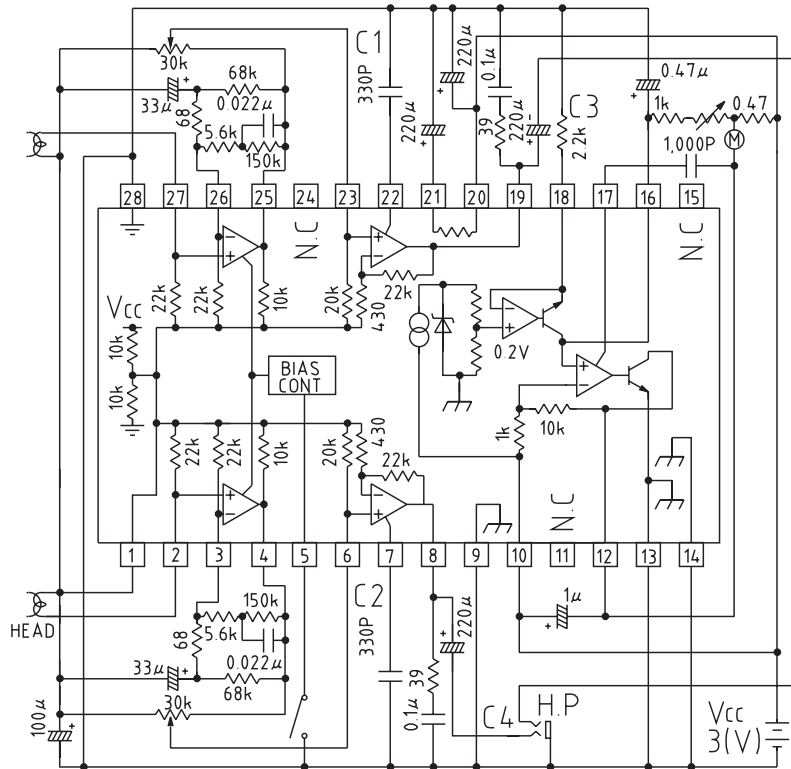

Characteristics

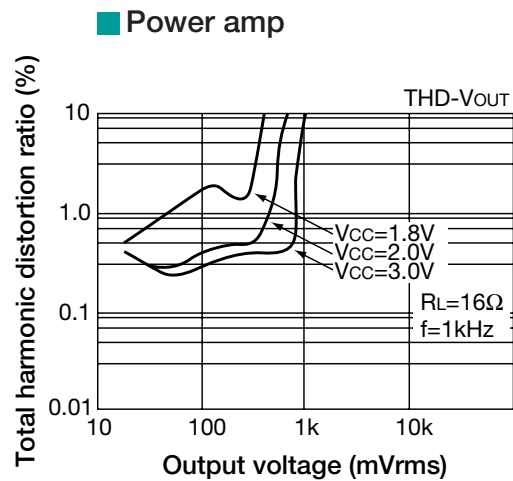
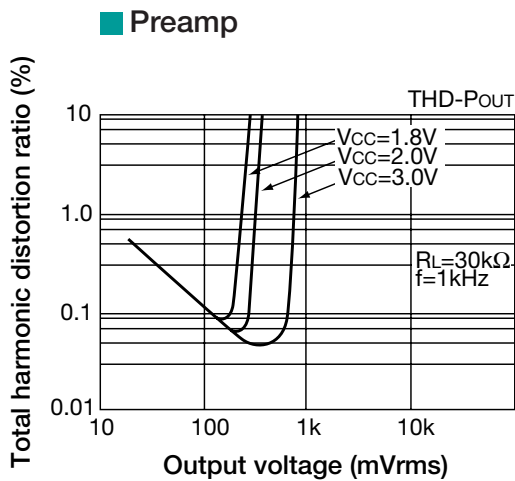

■ Power amp

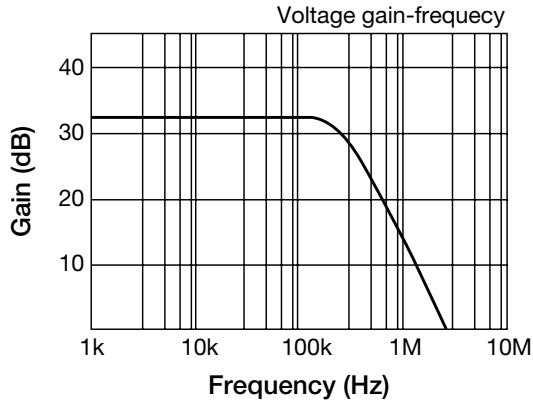

■ Pre+power amp

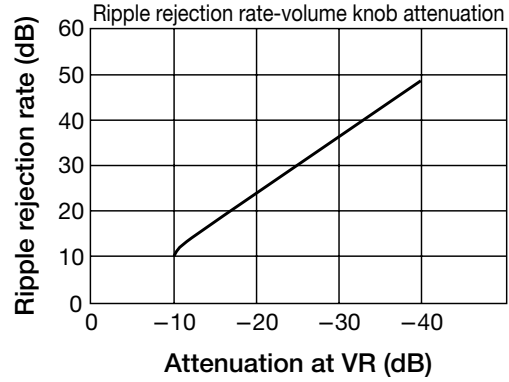

N-T characteristic

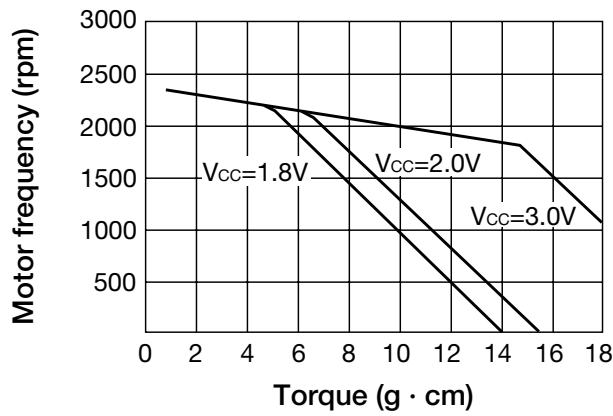

- ◇ Motor: RF300C
- ◇ Measurement circuit:

