

*Designer's™ Data Sheet*  
**SWITCHMODE™**  
**NPN Bipolar Power Transistor**  
**For Switching Power Supply Applications**

The MJE/MJF18004 have an applications specific state-of-the-art die designed for use in 220 V line operated Switchmode Power supplies and electronic light ballasts. This high voltage/high speed transistors offer the following:

- Improved Efficiency Due to Low Base Drive Requirements:
  - High and Flat DC Current Gain  $h_{FE}$
  - Fast Switching
  - No Coil Required in Base Circuit for Turn-Off (No Current Tail)
- Full Characterization at 125°C
- Motorola "6 SIGMA" Philosophy Provides Tight and Reproducible Parametric Distributions
- Two Package Choices: Standard TO-220 or Isolated TO-220
- MJF18004, Case 221D, is UL Recognized at 3500 V<sub>RMS</sub>: File #E69369

**MAXIMUM RATINGS**

Rating	Symbol	MJE18004	MJF18004	Unit
Collector-Emitter Sustaining Voltage	V <sub>CEO</sub>	450		Vdc
Collector-Emitter Breakdown Voltage	V <sub>CES</sub>	1000		Vdc
Emitter-Base Voltage	V <sub>EBO</sub>	9.0		Vdc
Collector Current — Continuous	I <sub>C</sub>	5.0		Adc
— Peak(1)	I <sub>CM</sub>	10		
Base Current — Continuous	I <sub>B</sub>	2.0		Adc
— Peak(1)	I <sub>BM</sub>	4.0		
RMS Isolation Voltage(2) Test No. 1 Per Fig. 22a (for 1 sec, R.H. Test No. 2 Per Fig. 22b < 30%, T <sub>A</sub> = 25°C) Test No. 3 Per Fig. 22c	V <sub>ISOL</sub>	—	4500 3500 1500	Volts
Total Device Dissipation (T <sub>C</sub> = 25°C) Derate above 25°C	P <sub>D</sub>	75 0.6	35 0.28	Watts W/°C
Operating and Storage Temperature	T <sub>J</sub> , T <sub>stg</sub>	-65 to 150		°C

**THERMAL CHARACTERISTICS**

Rating	Symbol	MJE18004	MJF18004	Unit
Thermal Resistance — Junction to Case	R <sub>θJC</sub>	1.65	3.55	°C/W
— Junction to Ambient	R <sub>θJA</sub>	62.5	62.5	
Maximum Lead Temperature for Soldering Purposes: 1/8" from Case for 5 Seconds	T <sub>L</sub>	260		°C

**ELECTRICAL CHARACTERISTICS** (T<sub>C</sub> = 25°C unless otherwise specified)

Characteristic	Symbol	Min	Typ	Max	Unit
----------------	--------	-----	-----	-----	------

**OFF CHARACTERISTICS**

Collector-Emitter Sustaining Voltage (I <sub>C</sub> = 100 mA, L = 25 mH)	V <sub>CEO(sus)</sub>	450	—	—	Vdc
Collector Cutoff Current (V <sub>CE</sub> = Rated V <sub>CEO</sub> , I <sub>B</sub> = 0)	I <sub>CEO</sub>	—	—	100	μAdc
Collector Cutoff Current (V <sub>CE</sub> = Rated V <sub>CES</sub> , V <sub>EB</sub> = 0)	I <sub>CES</sub>	—	—	100	μAdc
(V <sub>CE</sub> = 800 V, V <sub>EB</sub> = 0)		—	—	500	
(V <sub>CE</sub> = 800 V, V <sub>EB</sub> = 0)		—	—	100	
Emitter Cutoff Current (V <sub>EB</sub> = 9.0 Vdc, I <sub>C</sub> = 0)	I <sub>EBO</sub>	—	—	100	μAdc

- (1) Pulse Test: Pulse Width = 5.0 ms, Duty Cycle ≤ 10%.  
(2) Proper strike and creepage distance must be provided.

(continued)

**Designer's Data for "Worst Case" Conditions** — The Designer's Data Sheet permits the design of most circuits entirely from the information presented. SOA Limit curves — representing boundaries on device characteristics — are given to facilitate "worst case" design.

**Preferred** devices are Motorola recommended choices for future use and best overall value.

Designer's and SWITCHMODE are trademarks of Motorola, Inc.

REV 3

**MJE18004\***  
**MJF18004\***

\*Motorola Preferred Device

**POWER TRANSISTOR**  
**5.0 AMPERES**  
**1000 VOLTS**  
**35 and 75 WATTS**

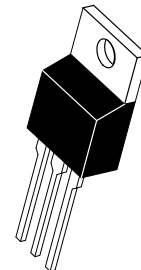

**CASE 221A-06**  
**TO-220AB**  
**MJE18004**

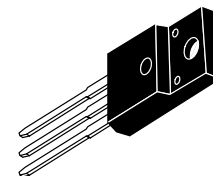

**CASE 221D-02**  
**ISOLATED TO-220 TYPE**  
**MJF18004**

**MJE18004 MJF18004**

**ELECTRICAL CHARACTERISTICS — continued** ( $T_C = 25^\circ\text{C}$  unless otherwise specified)

Characteristic	Symbol	Min	Typ	Max	Unit
<b>ON CHARACTERISTICS</b>					
Base–Emitter Saturation Voltage ( $I_C = 1.0\text{ Adc}, I_B = 0.1\text{ Adc}$ ) ( $I_C = 2.0\text{ Adc}, I_B = 0.4\text{ Adc}$ )	$V_{BE(sat)}$	— —	0.82 0.92	1.1 1.25	Vdc
Collector–Emitter Saturation Voltage ( $I_C = 1.0\text{ Adc}, I_B = 0.1\text{ Adc}$ )  ( $I_C = 2.0\text{ Adc}, I_B = 0.4\text{ Adc}$ )  ( $I_C = 2.5\text{ Adc}, I_B = 0.5\text{ Adc}$ )	$V_{CE(sat)}$	— — —	0.25 0.29 0.3 0.36 0.5	0.5 0.6 0.45 0.8 0.75	Vdc
DC Current Gain ( $I_C = 1.0\text{ Adc}, V_{CE} = 2.5\text{ Vdc}$ )  ( $I_C = 0.3\text{ Adc}, V_{CE} = 5.0\text{ Vdc}$ )  ( $I_C = 2.0\text{ Adc}, V_{CE} = 1.0\text{ Vdc}$ )  ( $I_C = 10\text{ mAdc}, V_{CE} = 5.0\text{ Vdc}$ )	$h_{FE}$	12 — 14 — 6.0 — 10	21 20 — 32 11 7.5 22	— — 34 — — — —	—

**DYNAMIC CHARACTERISTICS**

Current Gain Bandwidth ( $I_C = 0.5\text{ Adc}, V_{CE} = 10\text{ Vdc}, f = 1.0\text{ MHz}$ )	$f_T$	—	13	—	MHz		
Output Capacitance ( $V_{CB} = 10\text{ Vdc}, I_E = 0, f = 1.0\text{ MHz}$ )	$C_{ob}$	—	50	65	pF		
Input Capacitance ( $V_{EB} = 8.0\text{ V}$ )	$C_{ib}$	—	800	1000	pF		
Dynamic Saturation Voltage:  Determined $1.0\ \mu\text{s}$ and $3.0\ \mu\text{s}$ respectively after rising $I_{B1}$ reaches 90% of final $I_{B1}$ (see Figure 18)	$V_{CE(dsat)}$	$(I_C = 1.0\text{ Adc}, I_{B1} = 100\text{ mAdc}, V_{CC} = 300\text{ V})$  $(I_C = 2.0\text{ Adc}, I_{B1} = 400\text{ mAdc}, V_{CC} = 300\text{ V})$	$1.0\ \mu\text{s}$  $3.0\ \mu\text{s}$  $1.0\ \mu\text{s}$  $3.0\ \mu\text{s}$	$(T_C = 125^\circ\text{C})$  $(T_C = 125^\circ\text{C})$  $(T_C = 125^\circ\text{C})$  $(T_C = 125^\circ\text{C})$	— — — — — — — —	6.8 14 2.4 5.6 11.3 15.5 1.3 6.1	Vdc

**SWITCHING CHARACTERISTICS: Resistive Load** (D.C.  $\leq 10\%$ , Pulse Width =  $20\ \mu\text{s}$ )

Turn–On Time	$(I_C = 1.0\text{ Adc}, I_{B1} = 0.1\text{ Adc}, I_{B2} = 0.5\text{ Adc}, V_{CC} = 300\text{ V})$  ( $T_C = 125^\circ\text{C}$ )	$t_{on}$	— —	210 180	300 —	ns
Turn–Off Time		$t_{off}$	— —	1.0 1.3	1.7 —	$\mu\text{s}$
Turn–On Time	$(I_C = 2.0\text{ Adc}, I_{B1} = 0.4\text{ Adc}, I_{B2} = 1.0\text{ Adc}, V_{CC} = 300\text{ V})$  ( $T_C = 125^\circ\text{C}$ )	$t_{on}$	— —	75 90	110 —	ns
Turn–Off Time		$t_{off}$	— —	1.5 1.8	2.5 —	$\mu\text{s}$
Turn–On Time	$(I_C = 2.5\text{ Adc}, I_{B1} = 0.5\text{ Adc}, I_{B2} = 0.5\text{ Adc}, V_{CC} = 250\text{ V})$  ( $T_C = 125^\circ\text{C}$ )	$t_{on}$	— —	450 900	800 1400	ns
Storage Time		$t_s$	— —	2.0 2.2	3.0 3.5	$\mu\text{s}$
Fall Time		$t_f$	— —	275 500	400 800	ns

**ELECTRICAL CHARACTERISTICS — continued** ( $T_C = 25^\circ\text{C}$  unless otherwise specified)

Characteristic		Symbol	Min	Typ	Max	Unit
<b>SWITCHING CHARACTERISTICS: Inductive Load</b> ( $V_{\text{clamp}} = 300\text{ V}$ , $V_{\text{CC}} = 15\text{ V}$ , $L = 200\ \mu\text{H}$ )						
Fall Time	$(I_C = 1.0\text{ Adc}, I_{B1} = 0.1\text{ Adc}, I_{B2} = 0.5\text{ Adc})$ ( $T_C = 125^\circ\text{C}$ )	$t_{\text{fi}}$	—	100	150	ns
Storage Time		$t_{\text{si}}$	—	1.1	1.7	$\mu\text{s}$
Crossover Time		$t_c$	—	180	250	ns
				100	—	
				160	—	
Fall Time	$(I_C = 2.0\text{ Adc}, I_{B1} = 0.4\text{ Adc}, I_{B2} = 1.0\text{ Adc})$ ( $T_C = 125^\circ\text{C}$ )	$t_{\text{fi}}$	—	90	175	ns
Storage Time		$t_{\text{si}}$	—	1.7	2.5	$\mu\text{s}$
Crossover Time		$t_c$	—	180	300	ns
				150	—	
				250	—	
Fall Time	$(I_C = 2.5\text{ Adc}, I_{B1} = 0.5\text{ Adc}, I_{B2} = 0.5\text{ Adc}, V_{\text{BE(off)}} = -5.0\text{ Vdc})$ ( $T_C = 125^\circ\text{C}$ )	$t_{\text{fi}}$	—	70	130	ns
Storage Time		$t_{\text{si}}$	—	0.75	1.0	$\mu\text{s}$
Crossover Time		$t_c$	—	250	350	ns
				100	175	
				1.0	1.3	
				250	500	

TYPICAL STATIC CHARACTERISTICS

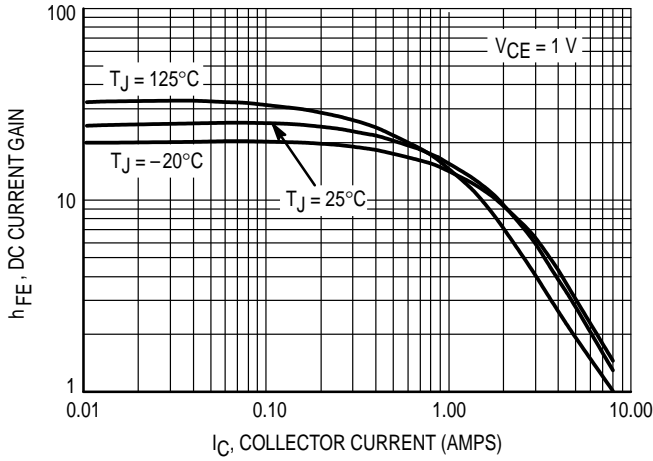

Figure 1. DC Current Gain @ 1 Volt

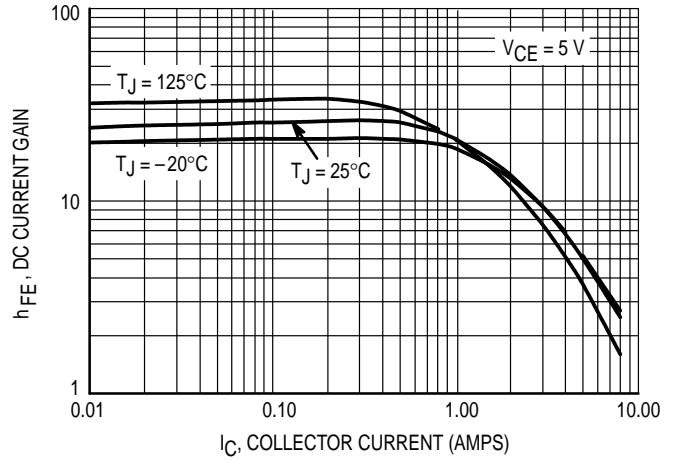

Figure 2. DC Current Gain @ 5 Volts

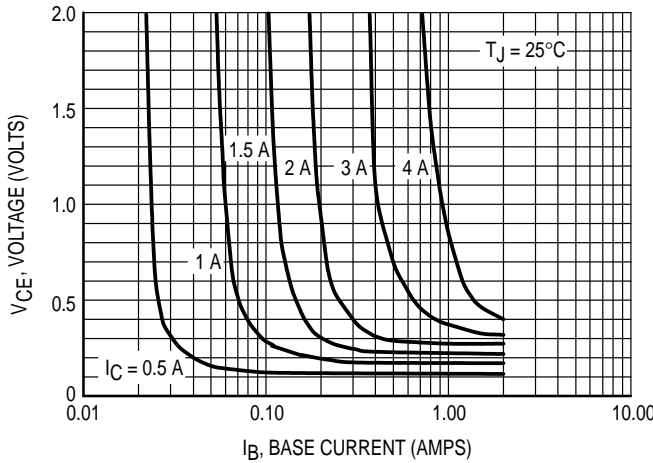

Figure 3. Collector Saturation Region

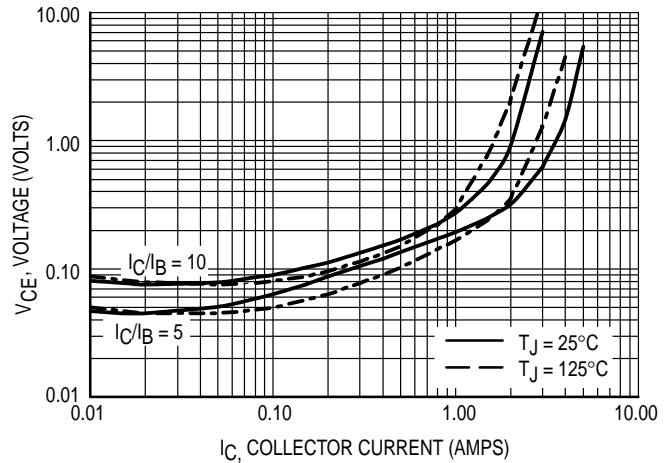

Figure 4. Collector-Emitter Saturation Voltage

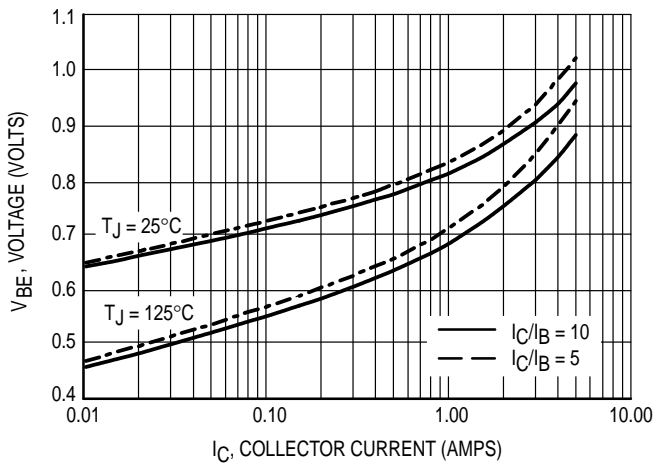

Figure 5. Base-Emitter Saturation Region

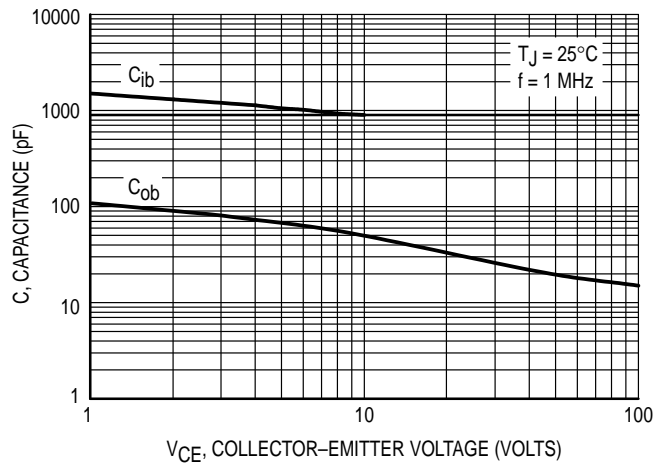
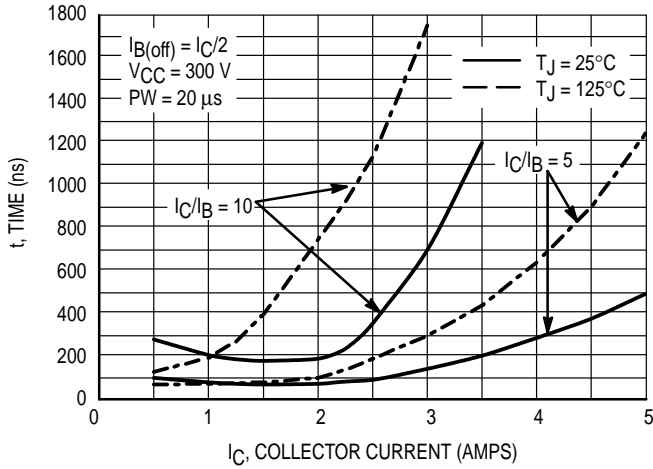
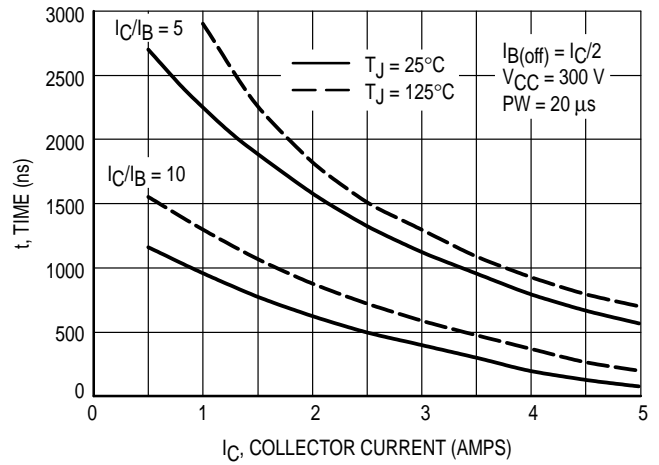

Figure 6. Capacitance

**TYPICAL SWITCHING CHARACTERISTICS**  
( $I_{B2} = I_C/2$  for all switching)



**Figure 7. Resistive Switching,  $t_{on}$**



**Figure 8. Resistive Switching,  $t_{off}$**

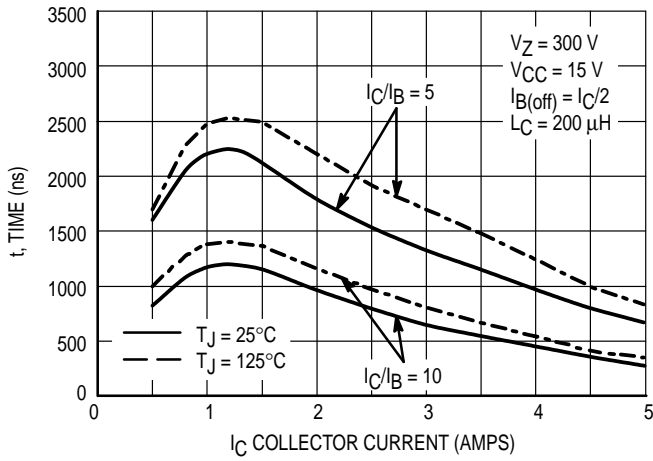

**Figure 9. Inductive Storage Time,  $t_{si}$**

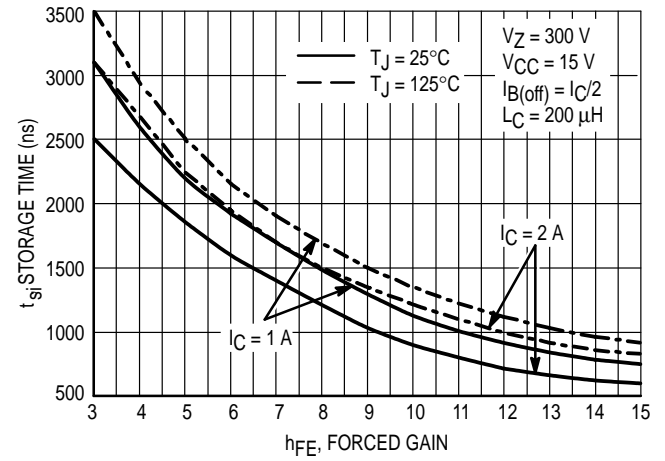

**Figure 10. Inductive Storage Time,  $t_{si}(h_{FE})$**

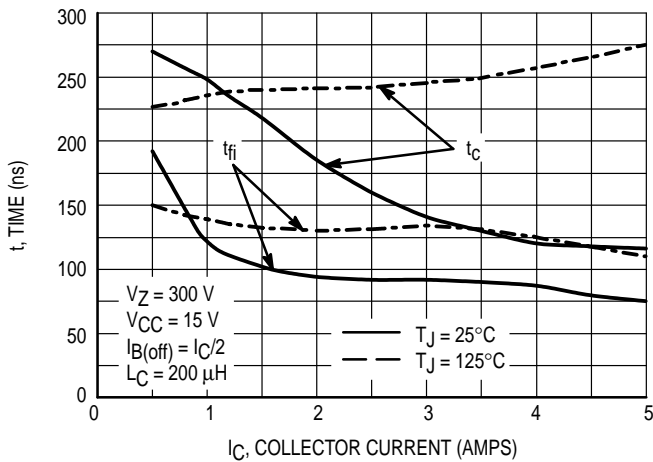

**Figure 11. Inductive Switching,  $t_c$  &  $t_{fi}$ ,  $I_C/I_B = 5$**

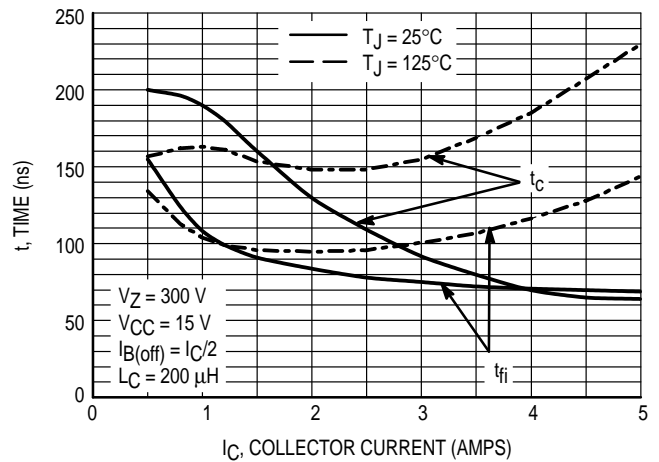

**Figure 12. Inductive Switching,  $t_c$  &  $t_{fi}$ ,  $I_C/I_B = 10$**

**TYPICAL SWITCHING CHARACTERISTICS**  
( $I_{B2} = I_C/2$  for all switching)

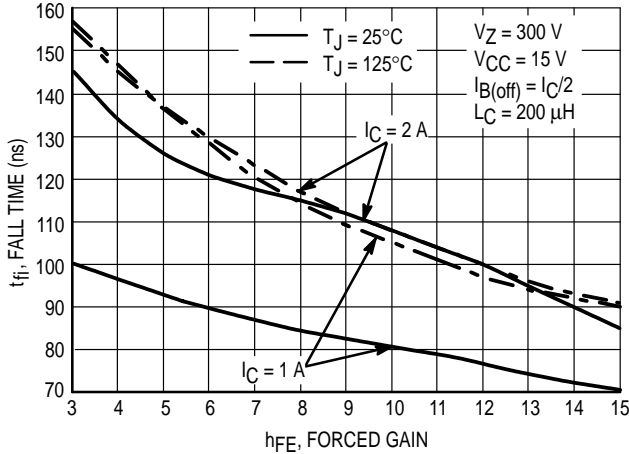

Figure 13. Inductive Fall Time

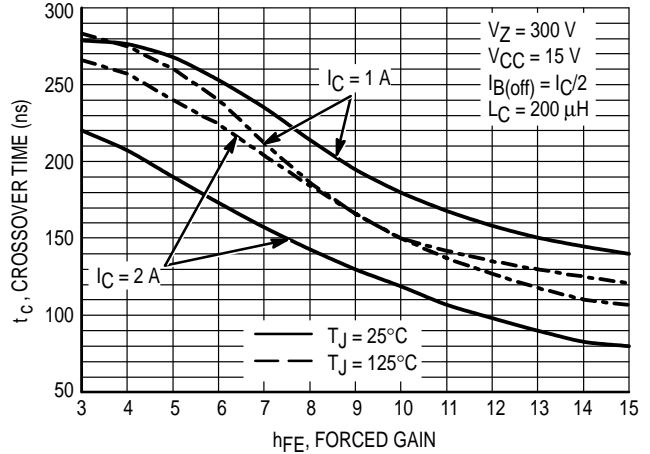

Figure 14. Inductive Crossover Time

**GUARANTEED SAFE OPERATING AREA INFORMATION**

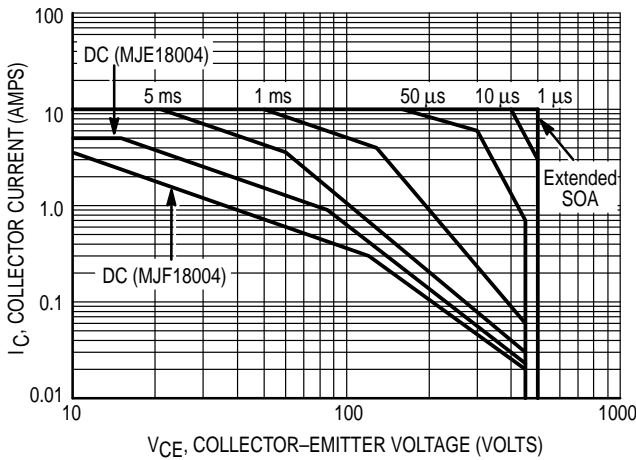

Figure 15. Forward Bias Safe Operating Area

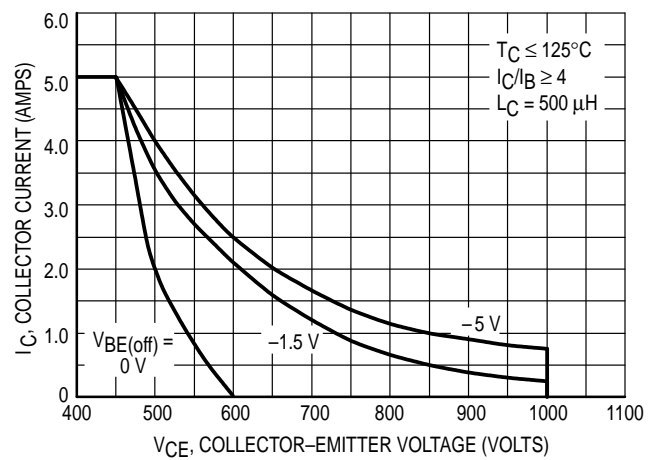

Figure 16. Reverse Bias Safe Operating Area

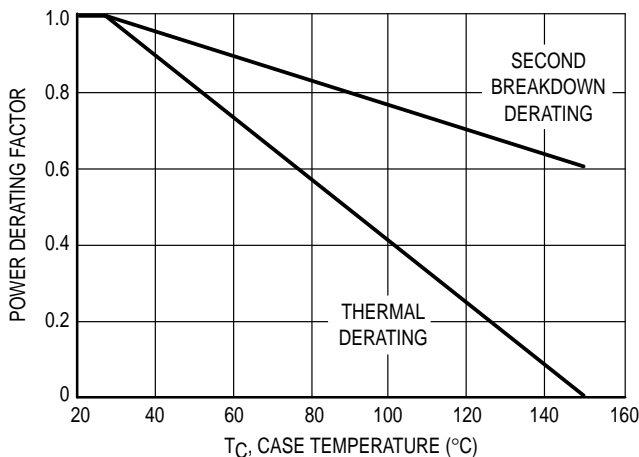

Figure 17. Forward Bias Power Derating

There are two limitations on the power handling ability of a transistor: average junction temperature and second breakdown. Safe operating area curves indicate  $I_C$ - $V_{CE}$  limits of the transistor that must be observed for reliable operation; i.e., the transistor must not be subjected to greater dissipation than the curves indicate. The data of Figure 15 is based on  $T_C = 25^\circ\text{C}$ ;  $T_J(\text{pk})$  is variable depending on power level. Second breakdown pulse limits are valid for duty cycles to 10% but must be derated when  $T_C \geq 25^\circ\text{C}$ . Second breakdown limitations do not derate the same as thermal limitations. Allowable current at the voltages shown on Figure 15 may be found at any case temperature by using the appropriate curve on Figure 17.  $T_J(\text{pk})$  may be calculated from the data in Figures 20 and 21. At any case temperatures, thermal limitations will reduce the power that can be handled to values less the limitations imposed by second breakdown. For inductive loads, high voltage and current must be sustained simultaneously during turn-off with the base-to-emitter junction reverse biased. The safe level is specified as a reverse-biased safe operating area (Figure 16). This rating is verified under clamped conditions so that the device is never subjected to an avalanche mode.

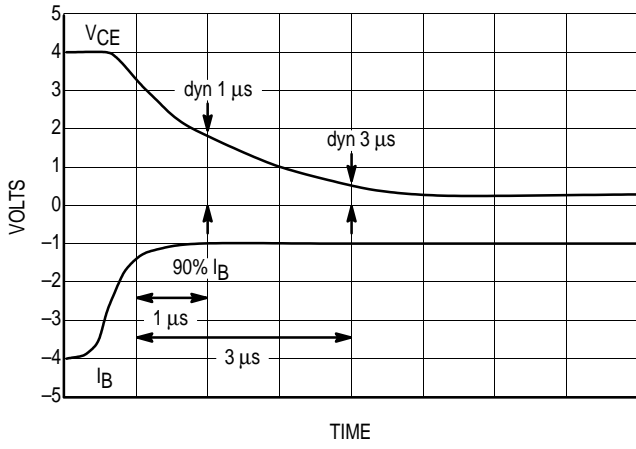

Figure 18. Dynamic Saturation Voltage Measurements

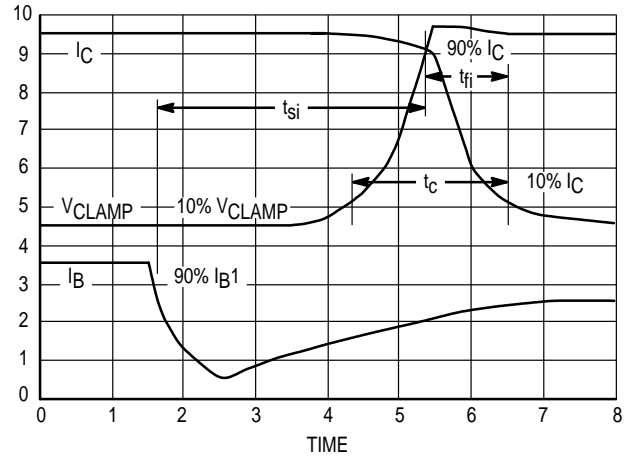

Figure 19. Inductive Switching Measurements

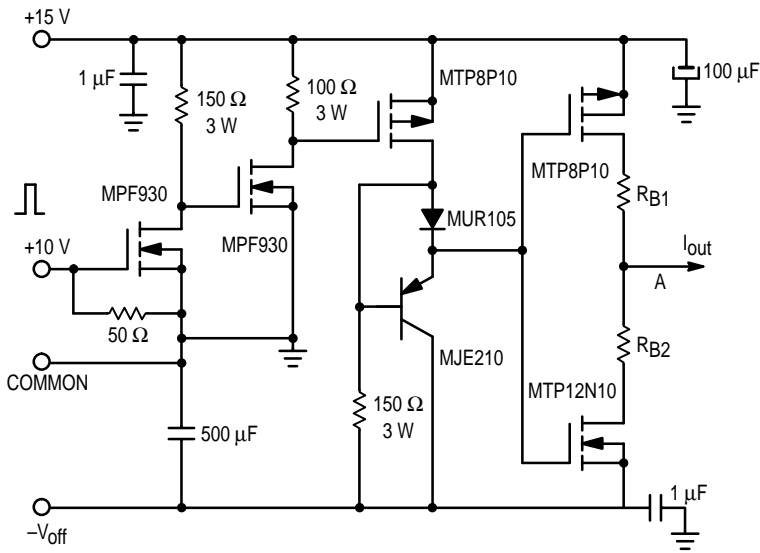
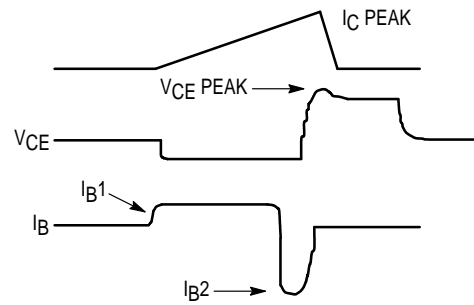

Table 1. Inductive Load Switching Drive Circuit



V(BR)CEO(sus)	INDUCTIVE SWITCHING	RBSOA
L = 10 mH	L = 200 μH	L = 500 μH
RB2 = ∞	RB2 = 0	RB2 = 0
VCC = 20 VOLTS	VCC = 15 VOLTS	VCC = 15 VOLTS
IC(pk) = 100 mA	RB1 SELECTED FOR DESIRED IB1	RB1 SELECTED FOR DESIRED IB1

TYPICAL THERMAL RESPONSE

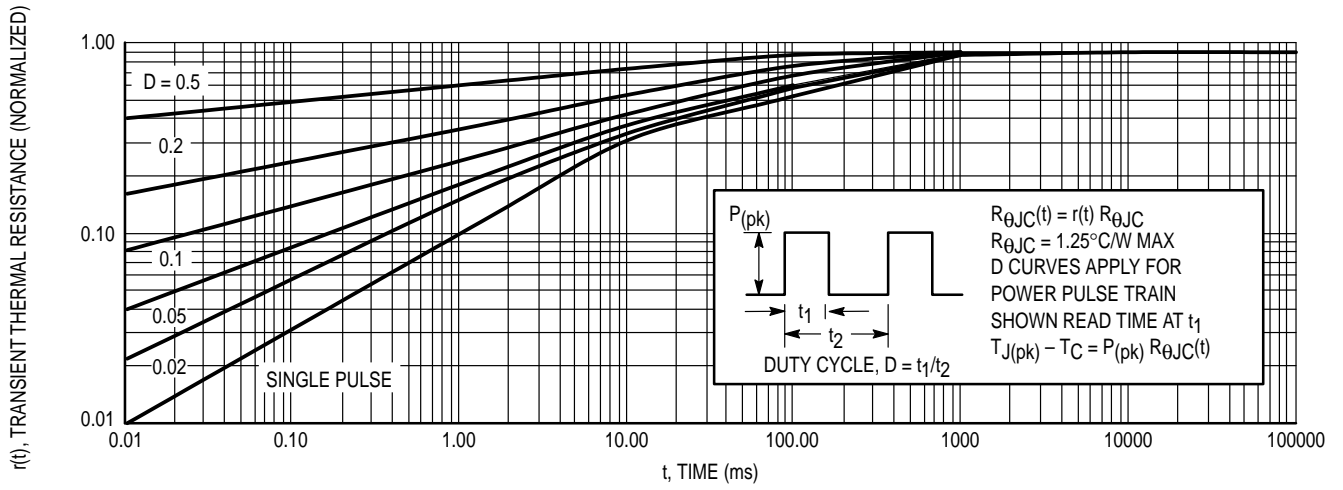

Figure 20. Typical Thermal Response ( $Z_{\theta JC}(t)$ ) for MJE18004

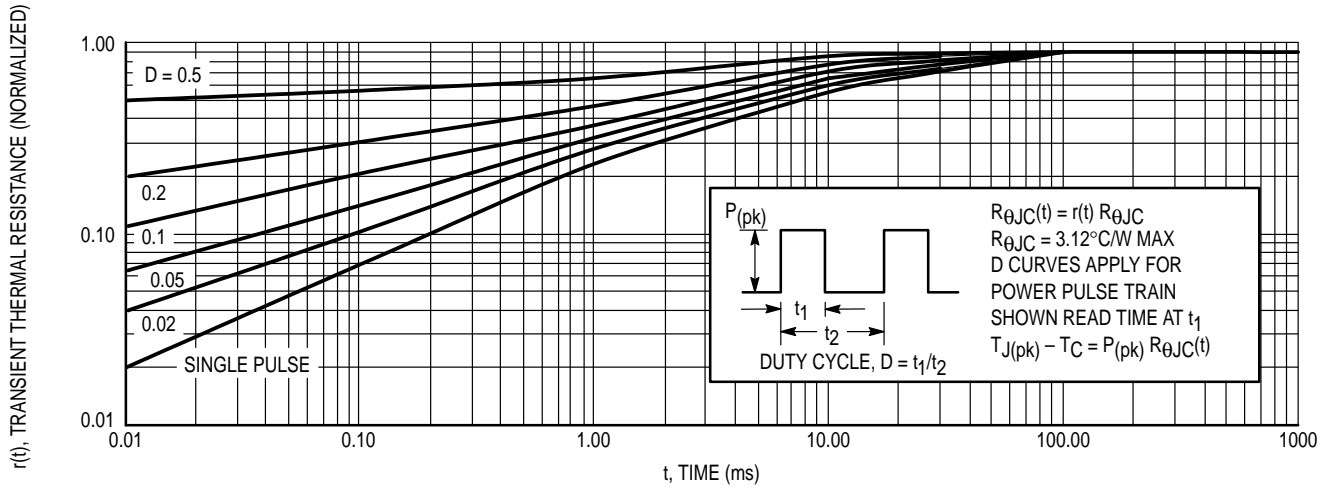
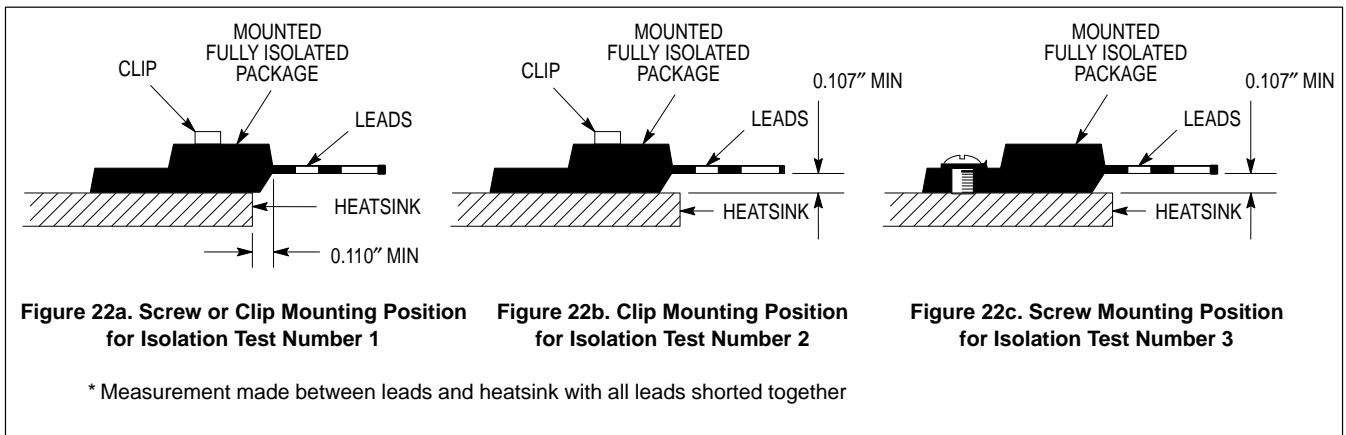

Figure 21. Typical Thermal Response for MJF18004



TEST CONDITIONS FOR ISOLATION TESTS\*



MOUNTING INFORMATION\*\*

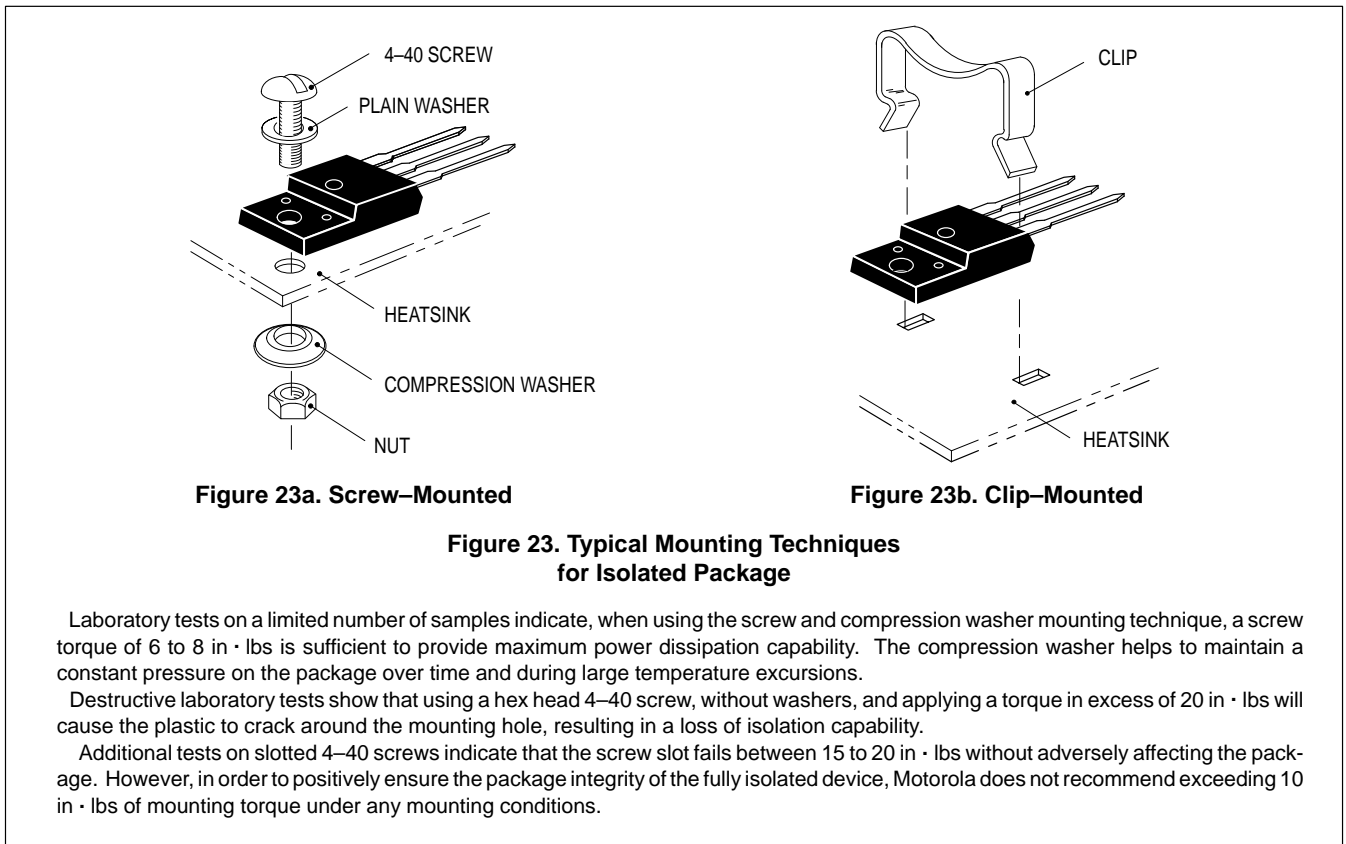

\*\* For more information about mounting power semiconductors see Application Note AN1040.

Motorola reserves the right to make changes without further notice to any products herein. Motorola makes no warranty, representation or guarantee regarding the suitability of its products for any particular purpose, nor does Motorola assume any liability arising out of the application or use of any product or circuit, and specifically disclaims any and all liability, including without limitation consequential or incidental damages. "Typical" parameters can and do vary in different applications. All operating parameters, including "Typicals" must be validated for each customer application by customer's technical experts. Motorola does not convey any license under its patent rights nor the rights of others. Motorola products are not designed, intended, or authorized for use as components in systems intended for surgical implant into the body, or other applications intended to support or sustain life, or for any other application in which the failure of the Motorola product could create a situation where personal injury or death may occur. Should Buyer purchase or use Motorola products for any such unintended or unauthorized application, Buyer shall indemnify and hold Motorola and its officers, employees, subsidiaries, affiliates, and distributors harmless against all claims, costs, damages, and expenses, and reasonable attorney fees arising out of, directly or indirectly, any claim of personal injury or death associated with such unintended or unauthorized use, even if such claim alleges that Motorola was negligent regarding the design or manufacture of the part. Motorola and are registered trademarks of Motorola, Inc. Motorola, Inc. is an Equal Opportunity/Affirmative Action Employer.

PACKAGE DIMENSIONS

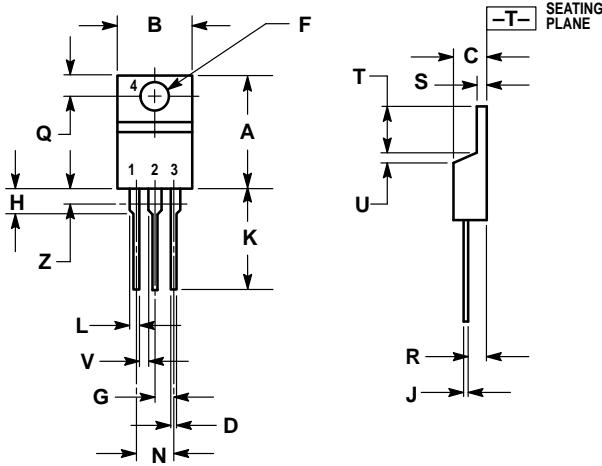

- NOTES:  
 1. DIMENSIONING AND TOLERANCING PER ANSI Y14.5M, 1982.  
 2. CONTROLLING DIMENSION: INCH.  
 3. DIMENSION Z DEFINES A ZONE WHERE ALL BODY AND LEAD IRREGULARITIES ARE ALLOWED.

DIM	INCHES		MILLIMETERS	
	MIN	MAX	MIN	MAX
A	0.570	0.620	14.48	15.75
B	0.380	0.405	9.66	10.28
C	0.160	0.190	4.07	4.82
D	0.025	0.035	0.64	0.88
F	0.142	0.147	3.61	3.73
G	0.095	0.105	2.42	2.66
H	0.110	0.155	2.80	3.93
J	0.018	0.025	0.46	0.64
K	0.500	0.562	12.70	14.27
L	0.045	0.060	1.15	1.52
N	0.190	0.210	4.83	5.33
Q	0.100	0.120	2.54	3.04
R	0.080	0.110	2.04	2.79
S	0.045	0.055	1.15	1.39
T	0.235	0.255	5.97	6.47
U	0.000	0.050	0.00	1.27
V	0.045	—	1.15	—
Z	—	0.080	—	2.04

- STYLE 1:  
 PIN 1. BASE  
 2. COLLECTOR  
 3. EMITTER  
 4. COLLECTOR

CASE 221A-06  
 TO-220AB  
 ISSUE Y

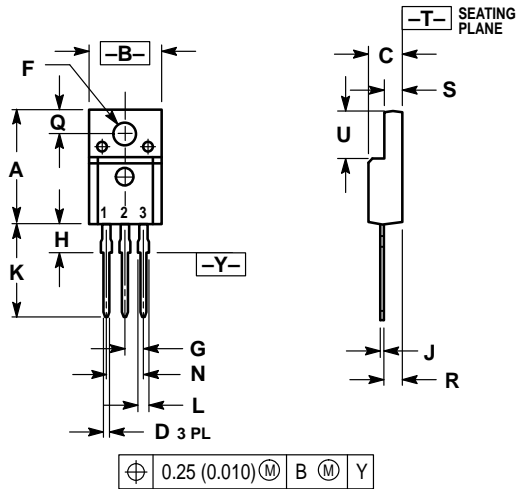

- NOTES:  
 1. DIMENSIONING AND TOLERANCING PER ANSI Y14.5M, 1982.  
 2. CONTROLLING DIMENSION: INCH.

DIM	INCHES		MILLIMETERS	
	MIN	MAX	MIN	MAX
A	0.621	0.629	15.78	15.97
B	0.394	0.402	10.01	10.21
C	0.181	0.189	4.60	4.80
D	0.026	0.034	0.67	0.86
F	0.121	0.129	3.08	3.27
G	0.100 BSC	—	2.54 BSC	—
H	0.123	0.129	3.13	3.27
J	0.018	0.025	0.46	0.64
K	0.500	0.562	12.70	14.27
L	0.045	0.060	1.14	1.52
N	0.200 BSC	—	5.08 BSC	—
Q	0.126	0.134	3.21	3.40
R	0.107	0.111	2.72	2.81
S	0.096	0.104	2.44	2.64
U	0.259	0.267	6.58	6.78

- STYLE 2:  
 PIN 1. BASE  
 2. COLLECTOR  
 3. EMITTER

CASE 221D-02  
 (ISOLATED TO-220 TYPE)  
 UL RECOGNIZED: FILE #E69369  
 ISSUE D

How to reach us:  
 USA/EUROPE: Motorola Literature Distribution;  
 P.O. Box 20912; Phoenix, Arizona 85036. 1-800-441-2447

JAPAN: Nippon Motorola Ltd.; Tatsumi-SPD-JLDC, Toshikatsu Otsuki,  
 6F Seibu-Butsuryu-Center, 3-14-2 Tatsumi Koto-Ku, Tokyo 135, Japan. 03-3521-8315

MFAX: RMFAX0@email.sps.mot.com - TOUCHTONE (602) 244-6609  
 INTERNET: http://Design-NET.com

HONG KONG: Motorola Semiconductors H.K. Ltd.; 8B Tai Ping Industrial Park,  
 51 Ting Kok Road, Tai Po, N.T., Hong Kong. 852-26629298

