



MIC5237

500mA Low-Dropout Regulator

Preliminary Information

General Description

The MIC5237 is a general-purpose low-dropout regulator capable of 500mA output current with better than 3% output voltage accuracy. Using Micrel's proprietary Super β PNP™ process with a PNP pass element, these regulators feature less than 300mV dropout voltage and typically 8mA ground current at full load.

Designed for applications that require moderate current over a broad input voltage range, including hand-held and battery-powered devices, the MIC5237 is intended for applications that can tolerate moderate voltage drop at higher current.

Key features include low ground current to help prolong battery life, reversed-battery protection, current limiting, over-temperature shutdown, and thermally efficient packaging. The MIC5237 is available in fixed output voltages only.

For space-critical applications and improved performance, see the MIC5209 and MIC5219. For output current requirements up to 750mA, see the MIC2937.

Features

- Guaranteed 500mA output over the full operating temperature range
- Low 300mV typical dropout voltage at full load
- Extremely tight load and line regulation
- Current and thermal limiting
- Reversed-battery protection
- TO-220 and TO-263 packages
- Low temperature coefficient
- No-load stability
- Low-noise output

Applications

- Portable and laptop computers
- Desktop computer
- Battery chargers
- SMPS post-regulator/dc-to-dc modules
- Consumer and personal electronics

Ordering Information

Part Number	Voltage	Junct. Temp. Range	Package
MIC5237-2.5BT	2.5V	-40°C to +125°C	TO-220
MIC5237-2.5BU	2.5V	-40°C to +125°C	TO-263
MIC5237-3.3BT	3.3V	-40°C to +125°C	TO-220
MIC5237-3.3BU	3.3V	-40°C to +125°C	TO-263
MIC5237-5.0BT	5.0V	-40°C to +125°C	TO-220
MIC5237-5.0BU	5.0V	-40°C to +125°C	TO-263

Typical Application

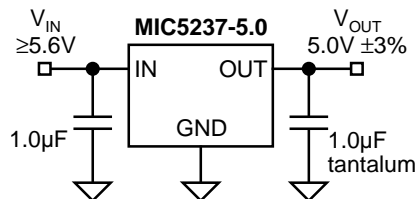

Pin Configuration

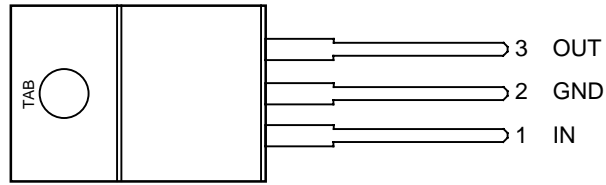

**MIC5237-x.xBT
(TO-220-3)**

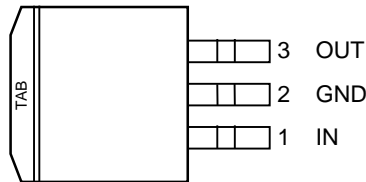

**MIC5237-x.xBU
(TO-263-3)**

Pin Description

Pin No.	Pin Name	Pin Function
1	IN	Supply Input
2, TAB	GND	Ground: TO-220 and TO-263 pin 2 and TAB are internally connected.
3	OUT	Regulator Output

Absolute Maximum Ratings

Input Voltage (V_{IN})	-20V to +20V
Power Dissipation (P_D)	Internally Limited
Junction Temperature (T_J)	-40°C to +125°C
Lead Temperature (soldering, 5 sec.)	260°C

Operating Ratings

Input Voltage (V_{IN})	+2.5V to +16V
Junction Temperature (T_J)	-40°C to +125°C
Package Thermal Resistance	
TO-220 (θ_{JA})	55°C/W
TO-220 (θ_{JC})	3°C/W
TO-263 (θ_{JC})	3°C/W

Electrical Characteristics

$V_{IN} = V_{OUT} + 1.0V$; $C_{OUT} = 4.7\mu F$, $I_{OUT} = 100\mu A$; $T_J = 25^\circ C$, **bold** values indicate $-40^\circ C \leq T_J \leq +125^\circ C$; unless noted.

Symbol	Parameter	Conditions	Min	Typical	Max	Units
V_{OUT}	Output Voltage Accuracy	variation from nominal V_{OUT}	-3 -5		3 5	% %
$\Delta V_{OUT}/\Delta T$	Output Voltage Temperature Coefficient	Note 2		40		ppm/ $^\circ C$
$\Delta V_{OUT}/V_{OUT}$	Line Regulation	$V_{IN} = V_{OUT} + 1V$ to 16V		0.015	0.05 0.1	%/V %/V
$\Delta V_{OUT}/V_{OUT}$	Load Regulation	$I_{OUT} = 100\mu A$ to 500mA, Note 3		0.05	0.5 0.7	% %
$V_{IN} - V_{OUT}$	Dropout Voltage, Note 4	$I_{OUT} = 100\mu A$		10	70 90	mV mV
		$I_{OUT} = 50mA$		115	190 280	mV mV
		$I_{OUT} = 150mA$		165	350 450	mV mV
		$I_{OUT} = 500mA$		300	600 700	mV mV
I_{GND}	Ground Pin Current, Note 5	$I_{OUT} = 100\mu A$		80	130 170	μA μA
		$I_{OUT} = 50mA$		350	650 900	μA μA
		$I_{OUT} = 150mA$		1.8	2.5 3.0	mA mA
		$I_{OUT} = 500mA$		8	15 20	mA mA
PSRR	Ripple Rejection	$f = 120Hz$		75		dB
I_{LIMIT}	Current Limit	$V_{OUT} = 0V$		700	900 1000	mA
$\Delta V_{OUT}/\Delta P_D$	Thermal Regulation	Note 6		0.05		%/W
e_{no}	Output Noise	$V_{OUT} = 5.0V$, $I_{OUT} = 50mA$, $C_{OUT} = 2.2\mu F$		500		nV/ \sqrt{Hz}

Note 1: Absolute maximum ratings indicate limits beyond which damage to the component may occur. Electrical specifications do not apply when operating the device outside of its operating ratings. The maximum allowable power dissipation is a function of the maximum junction temperature, $T_{J(max)}$, the junction-to-ambient thermal resistance, θ_{JA} , and the ambient temperature, T_A . The maximum allowable power dissipation at any ambient temperature is calculated using: $P_{D(max)} = (T_{J(max)} - T_A) / \theta_{JA}$. Exceeding the maximum allowable power dissipation will result in excessive die temperature, and the regulator will go into thermal shutdown. See the "Thermal Considerations" section for details.

Note 2: Output voltage temperature coefficient is defined as the worst case voltage change divided by the total temperature range.

Note 3: Regulation is measured at constant junction temperature using low duty cycle pulse testing. Parts are tested for load regulation in the load range from 100 μA to 500mA. Changes in output voltage due to heating effects are covered by the thermal regulation specification.

Note 4: Dropout voltage is defined as the input to output differential at which the output voltage drops 2% below its nominal value measured at 1V differential.

Note 5: Ground pin current is the regulator quiescent current plus pass transistor base current. The total current drawn from the supply is the sum of the load current plus the ground pin current.

Note 6: Thermal regulation is defined as the change in output voltage at a time "t" after a change in power dissipation is applied, excluding load or line regulation effects. Specifications are for a 500mA load pulse at $V_{IN} = 16V$ for $t = 10ms$.

Block Diagram

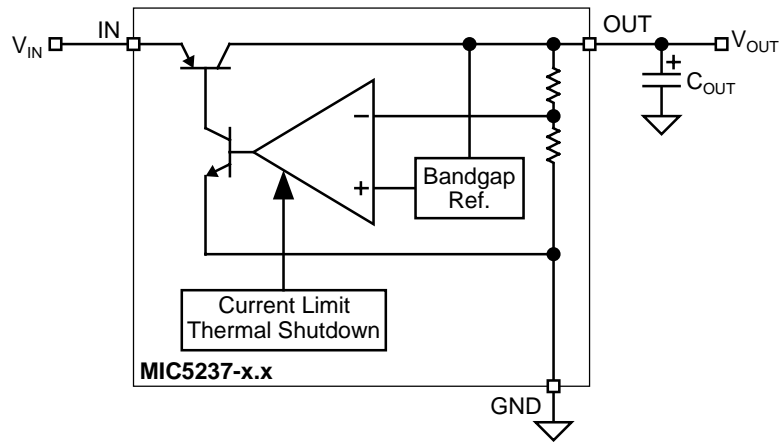

Fixed Regulator

Typical Characteristics

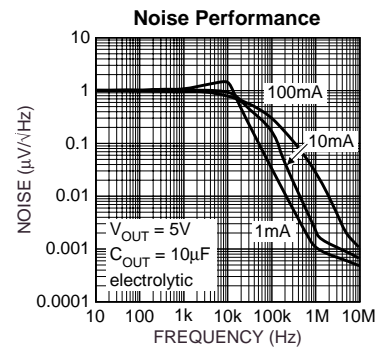
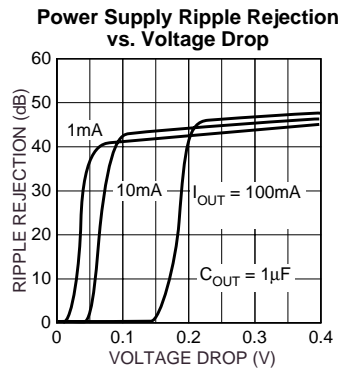
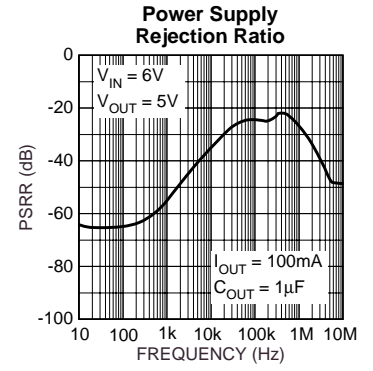
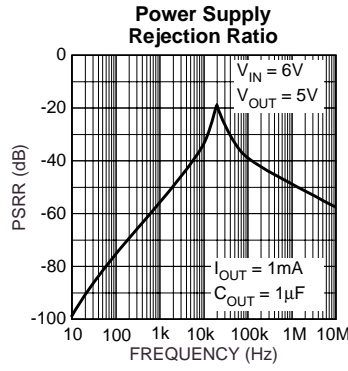
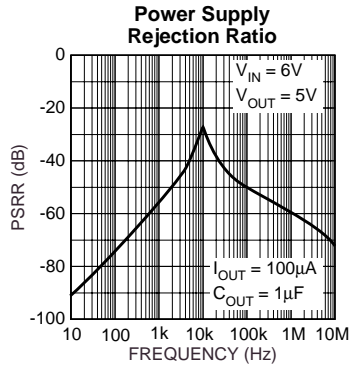

Applications Information

The MIC5237 is intended for general-purpose use and can be implemented in a wide variety of applications where 500mA of output current is needed. It is available in several voltage options for ease of use. For voltage options that are not available on the MIC5237, consult the MIC5209 for a 500mA adjustable LDO regulator, or the MIC5219 for applications that require only short-duration peak output current.

Input Capacitor

A 1 μ F capacitor should be placed from IN to GND if there is more than 10 inches of wire between the input and the ac filter capacitor or if a battery is used as the input.

Output Capacitor

An output capacitor is required between OUT and GND to prevent oscillation. 1 μ F minimum is recommended for standard applications. Larger values improve the regulator's transient response. The output capacitor value may be increased without limit.

The output capacitor should have an ESR (equivalent series resistance) of about 5 Ω or less and a resonant frequency above 1MHz. Ultralow-ESR capacitors can cause low-amplitude oscillations and/or underdamped transient response. Most tantalum or aluminum electrolytic capacitors are adequate; film types will work, but are more expensive. Since many aluminum electrolytics have electrolytes that freeze at about -30°C , solid tantalums are recommended for operation below -25°C .

At lower values of output current, less output capacitance is needed for output stability. The capacitor can be reduced to 0.47 μ F for current below 10mA or 0.33 μ F for currents below 1mA.

For 2.5V applications a 22 μ F output capacitor is recommended to reduce startup voltage overshoot.

No-Load Stability

The MIC5237 will remain stable and in regulation with no load (other than the internal voltage divider) unlike many other voltage regulators. This is especially important in CMOS RAM keep-alive applications.

Thermal Considerations

Proper thermal design can be accomplished with some basic design criteria and some simple equations. The following information is required to implement a regulator design.

V_{IN} = input voltage

V_{OUT} = output voltage

I_{OUT} = output current

T_{A} = ambient operating temperature

I_{GND} = ground current

The regulator ground current, I_{GND} , can be measured or read from the data sheet. Assuming the worst case scenario is good design procedure, and the corresponding ground cur-

rent number can be obtained from the data sheet. First, calculate the power dissipation of the device. This example uses the MIC5237-5.0BT, a 13V input, and 500mA output current, which results in 20mA of ground current, worst case. The power dissipation is the sum of two power calculations: voltage drop \times output current and input voltage \times ground current.

$$P_{\text{D}} = [(V_{\text{IN}} - V_{\text{OUT}}) \times I_{\text{OUT}}] + (V_{\text{IN}} \times I_{\text{GND}})$$

$$P_{\text{D}} = [(13\text{V} - 5\text{V}) \times 500\text{mA}] + (13\text{V} \times 20\text{mA})$$

$$P_{\text{D}} = 4.260\text{W}$$

From this number, the heat sink thermal resistance is determined using the regulator's maximum operating junction temperature ($T_{\text{J(max)}}$) and the ambient temperature (T_{A}) along with the power dissipation number already calculated.

$$T_{\text{J(MAX)}} = 125^{\circ}\text{C}$$

θ_{JC} = junction-to-case thermal resistance

θ_{CS} = case-to-sink thermal resistance

θ_{JA} = junction-to-ambient thermal resistance

θ_{SA} = sink-to-ambient thermal resistance

To determine the heat sink thermal resistance, the junction-to-case thermal resistance of the device must be used along with the case-to-heat sink thermal resistance. These numbers show the heat-sink thermal resistance required at $T_{\text{A}} = 25^{\circ}\text{C}$ that does not exceed the maximum operating junction temperature.

$$\theta_{\text{JA}} = \frac{T_{\text{J(max)}} - T_{\text{A}}}{P_{\text{D}}}$$

$$\theta_{\text{SA}} = \theta_{\text{JA}} - \theta_{\text{JC}}$$

θ_{CS} is approximately 1°C/W and θ_{JC} for the TO-220 is 3°C/W in this example.

$$\theta_{\text{JA}} = \frac{125 - 25}{4.260\text{W}}$$

$$\theta_{\text{JA}} = 23.5^{\circ}\text{C/W}$$

$$\theta_{\text{SA}} = 23.5^{\circ}\text{C/W} - (3^{\circ}\text{C/W} + 1^{\circ}\text{C/W})$$

$$\theta_{\text{SA}} = 19.5^{\circ}\text{C/W}$$

Therefore, a heat sink with a thermal resistance of 19.5°C/W will allow the part to operate safely and it will not exceed the maximum junction temperature of the device. The heat sink can be reduced by limiting power dissipation, by reducing the input voltage or output current. Either the TO-220 or TO-263 package can operate reliably at 2W of power dissipation without a heat sink. Above 2W, a heat sink is recommended.

For a full discussion on voltage regulator thermal effects, please refer to "Thermal Management" in Micrel's *Designing with Low-Dropout Voltage Regulators* handbook.

Package Information

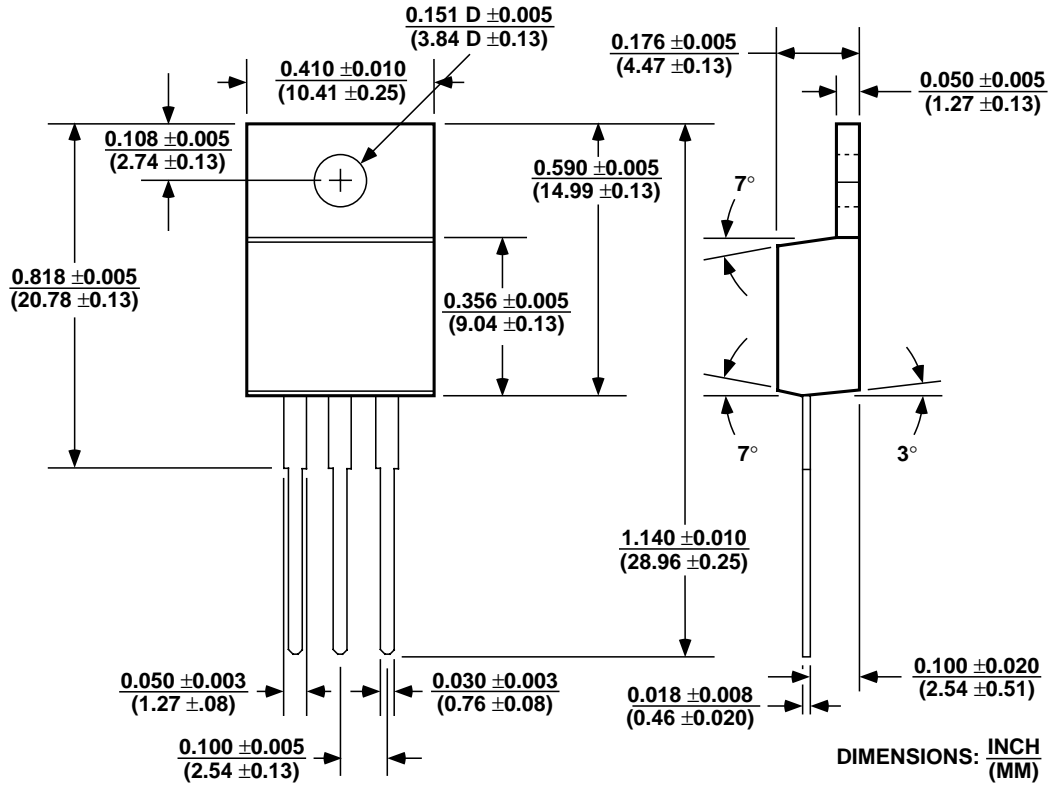

3-Lead TO-220 (T)

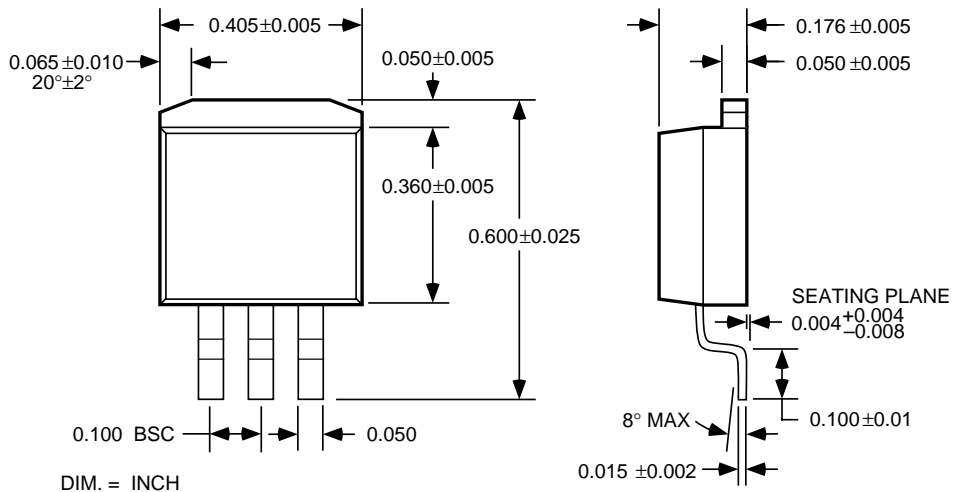

3-Lead TO-263 (U)

MICREL INC. 1849 FORTUNE DRIVE SAN JOSE, CA 95131 USA

TEL + 1 (408) 944-0800 FAX + 1 (408) 944-0970 WEB <http://www.micrel.com>

This information is believed to be accurate and reliable, however no responsibility is assumed by Micrel for its use nor for any infringement of patents or other rights of third parties resulting from its use. No license is granted by implication or otherwise under any patent or patent right of Micrel Inc.

© 2000 Micrel Incorporated