

## 200 mA Low Dropout Regulator

### Features

- High Output Voltage Accuracy
- Variety of Output Voltages
- Guaranteed 200 mA Output
- Low Quiescent Current
- Low Dropout Voltage
- Extremely Tight Load and Line Regulation
- Very Low Temperature Coefficient
- Current and Thermal Limiting
- Reversed-Battery Protection
- Load-Dump Protection (Fixed Voltage Versions)
- Zero Off-Mode Current
- Logic-Controlled Electronic Enable
- Available in SOIC-8 and SOT-223 Packages

### Applications

- Cellular Telephones
- Laptop, Notebook, and Palmtop Computers
- Battery Powered Equipment
- PCMCIA  $V_{CC}$  and  $V_{PP}$  Regulation/Switching
- Barcode Scanners
- SMPS Post-Regulator and DC/DC Modules
- High-Efficiency Linear Power Supplies

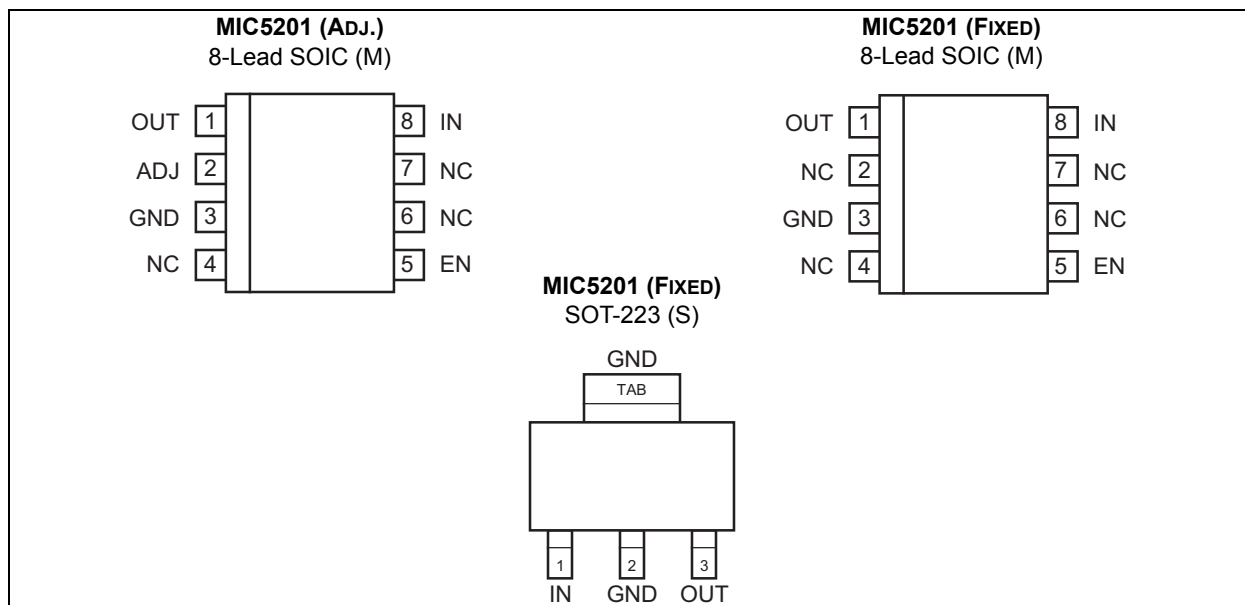
### General Description

The MIC5201 is an efficient linear voltage regulator with very low dropout voltage (typically 17 mV at light loads and 200 mV at 100 mA), and very low ground current (1 mA at 100 mA output), offering better than 1% initial accuracy with a logic compatible on-off switching input.

Designed especially for hand-held battery powered devices, the MIC5201 can be switched by a CMOS or TTL compatible enable signal. This enable control may be connected directly to  $V_{IN}$  if unneeded. When disabled, power consumption drops nearly to zero. The ground current of the MIC5201 increases only slightly in dropout, further prolonging battery life. Key MIC5201 features include current limiting, overtemperature shutdown, and protection against reversed battery.

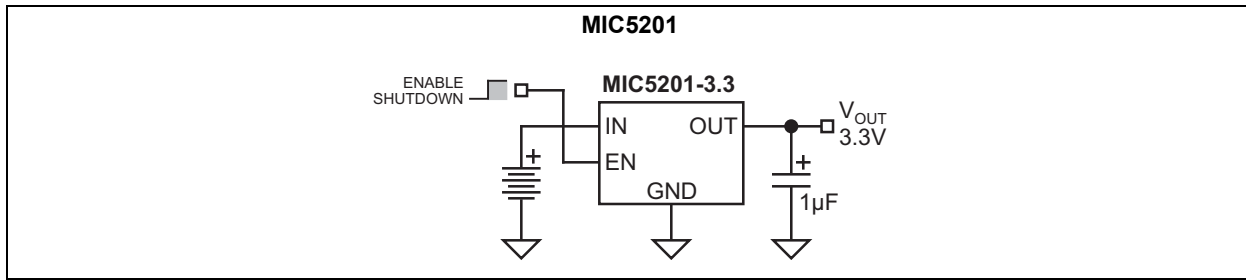
The MIC5201 is available in several fixed voltages and accuracy configurations. It features the same pinout as the LT1121 with better performance. Other options are available; contact Microchip for details.

### Package Types

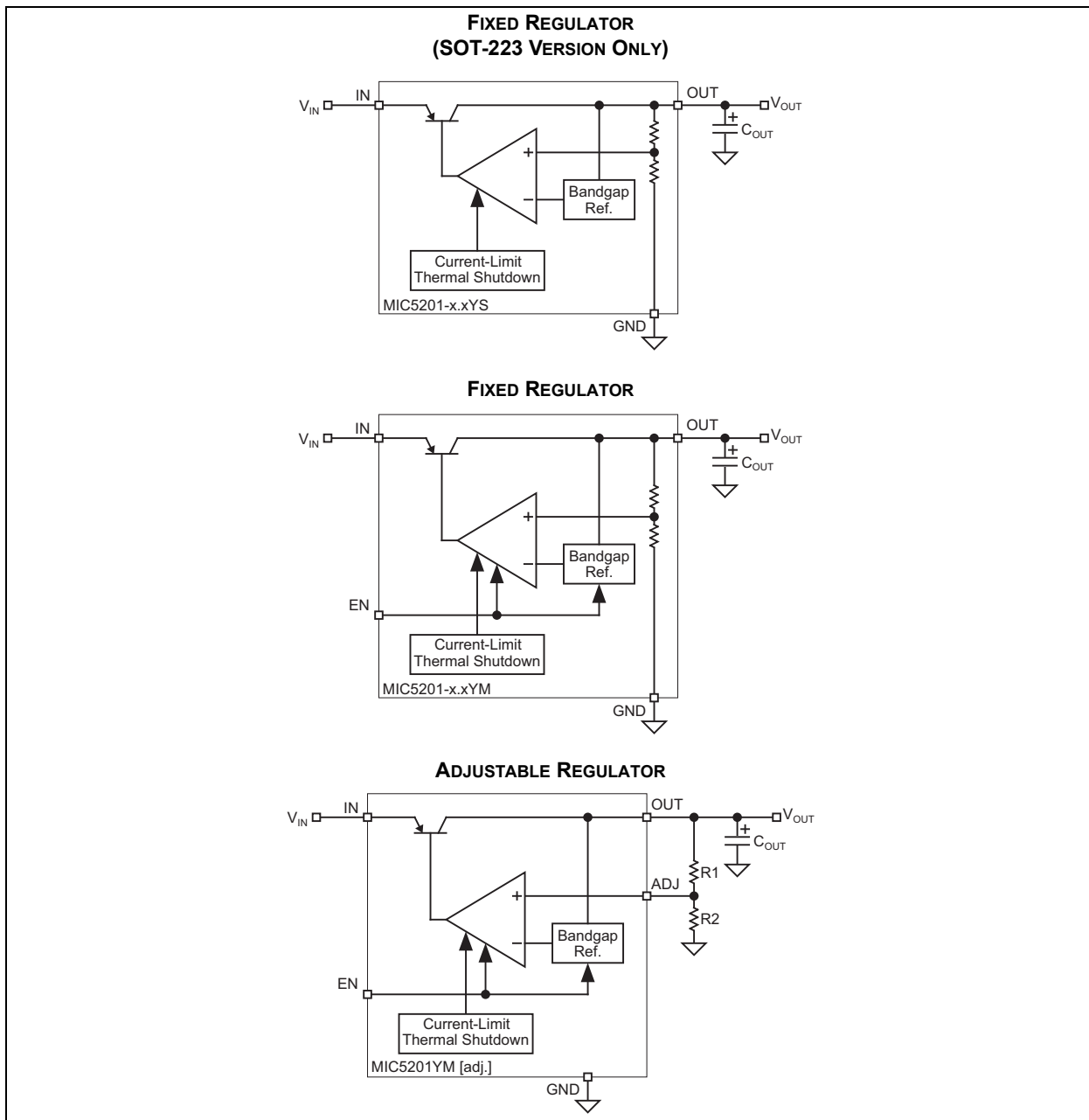


# MIC5201

## Typical Application Circuit



## Functional Diagrams



## 1.0 ELECTRICAL CHARACTERISTICS

### Absolute Maximum Ratings †

|  |                    |
|--|--------------------|
| Supply Input Voltage ( $V_{IN}$ ) Fixed.....       | -20V to +60V       |
| Supply Input Voltage ( $V_{IN}$ ) Adjustable.....  | -20V to +20V       |
| Enable Input Voltage ( $V_{EN}$ ) Fixed .....      | -20V to +60V       |
| Enable Input Voltage ( $V_{EN}$ ) Adjustable ..... | -20V to +20V       |
| Power Dissipation (Note 1) .....                   | Internally Limited |

### Operating Ratings ‡

|   |                |
|---|----------------|
| Supply Input Voltage ( $V_{IN}$ ) Fixed.....      | +2.5V to +26V  |
| Supply Input Voltage ( $V_{IN}$ ) Adjustable..... | +2.5V to +16V  |
| Enable Input Voltage ( $V_{EN}$ ) .....           | 0V to $V_{IN}$ |

† **Notice:** Stresses above those listed under “Absolute Maximum Ratings” may cause permanent damage to the device. This is a stress rating only and functional operation of the device at those or any other conditions above those indicated in the operational sections of this specification is not intended. Exposure to maximum rating conditions for extended periods may affect device reliability.

‡ **Notice:** The device is not guaranteed to function outside its operating ratings.

**Note 1:** The maximum allowable power dissipation is a function of the maximum junction temperature,  $T_{J(max)}$ , the junction-to-ambient thermal resistance,  $\theta_{JA}$ , and the ambient temperature,  $T_A$ . The maximum allowable power dissipation at any ambient temperature is calculated using:  $P_{(max)} = (T_{J(max)} - T_A) \div \theta_{JA}$ . Exceeding the maximum allowable power dissipation will result in excessive die temperature, and the regulator will go into thermal shutdown.

# MIC5201

**TABLE 1-1: ELECTRICAL CHARACTERISTICS (Note 1)**

**Electrical Characteristics:**  $V_{IN} = V_{OUT} + 1V$ ;  $I_L = 100 \mu A$ ;  $C_L = 3.3 \mu F$ ;  $V_{EN} \geq 2.0V$ ;  $T_J = +25^\circ C$ , **bold** values indicate  $-40^\circ C \leq T_J \leq +85^\circ C$ ; unless noted.

| Parameter                              | Symbol                    | Min.       | Typ.       | Max.        | Units           | Conditions   |
|--|---------------------------|------------|------------|-------------|-----------------|--|
| Output Voltage Accuracy                | $V_O$                     | -1         | —          | 1           | %               | Variation from specified $V_{OUT}$   |
|  |                           | <b>-2</b>  | —          | <b>2</b>    |                 |  |
| Output Voltage Temperature Coefficient | $\Delta V_O / \Delta T$   | —          | <b>40</b>  | <b>150</b>  | ppm/ $^\circ C$ | Note 2   |
| Line Regulation, Fixed                 | $\Delta V_O / \Delta V_O$ | —          | 0.004      | 0.20        | %               | $V_{IN} = V_{OUT} + 1V$ to 26V   |
|  |                           | —          | —          | <b>0.40</b> |                 |  |
| Line Regulation, Adjustable            | $\Delta V_O / \Delta V_O$ | —          | 0.004      | 0.20        | %               | $V_{IN} = V_{OUT} + 1V$ to 16V   |
|  |                           | —          | —          | <b>0.40</b> |                 |  |
| Load Regulation                        | $\Delta V_O / \Delta V_O$ | —          | 0.04       | 0.16        | %               | $I_L = 0.1 mA$ to 200 mA, Note 3   |
|  |                           | —          | —          | <b>0.30</b> |                 |  |
| Dropout Voltage, Note 4                | $V_{IN} - V_O$            | —          | 17         | —           | mV              | $I_L = 100 \mu A$  |
|  |                           | —          | 130        | —           |                 | $I_L = 20 mA$  |
|  |                           | —          | 180        | —           |                 | $I_L = 50 mA$  |
|  |                           | —          | 225        | —           |                 | $I_L = 100 mA$   |
|  |                           | —          | 270        | <b>400</b>  |                 | $I_L = 200 mA$   |
| Quiescent Current                      | $I_{GND}$                 | —          | 0.01       | —           | $\mu A$         | $V_{ENABLE} \leq 0.7V$ (shutdown)  |
| Ground Pin Current                     | $I_{GND}$                 | —          | 130        | —           | $\mu A$         | $I_L = 100 \mu A$  |
|  |                           | —          | 270        | 400         |                 | $I_L = 20 mA$  |
|  |                           | —          | 500        | —           |                 | $I_L = 50 mA$  |
|  |                           | —          | 1000       | <b>2000</b> |                 | $I_L = 100 mA$   |
|  |                           | —          | 3000       | —           |                 | $I_L = 200 mA$   |
| Ripple Rejection                       | PSRR                      | —          | 75         | —           | dB              | —  |
| Ground Pin Current at Dropout          | $I_{GDNDO}$               | —          | 270        | <b>330</b>  | $\mu A$         | $V_{IN} = 0.5V$ less than specified $V_{OUT}$ , $I_L = 100 \mu A$ , Note 5 |
| Current Limit                          | $I_{LIMIT}$               | —          | <b>280</b> | 500         | mA              | $V_{OUT} = 0V$   |
| Thermal Regulation                     | $\Delta V_O / \Delta P_D$ | —          | 0.05       | —           | %/W             | Note 6   |
| Output Noise                           | $e_n$                     | —          | 100        | —           | $\mu V$         | —  |
| <b>Enable Input</b>                    |                           |            |            |             |                 |  |
| Input Voltage Level                    | $V_{IL}$                  | —          | —          | <b>0.7</b>  | V               | Logic-low (off)  |
| Input Voltage Level                    | $V_{IH}$                  | <b>2.0</b> | —          | —           | V               | Logic-high (on)  |
| Enable Input Current                   | $I_{IL}$                  | —          | 0.01       | <b>1</b>    | $\mu A$         | $V_{IL} \leq 0.7V$   |
| Enable Input Current                   | $I_{IH}$                  | —          | 15         | <b>50</b>   | $\mu A$         | $V_{IH} \leq 2.0V$   |

**TABLE 1-1: ELECTRICAL CHARACTERISTICS (Note 1) (CONTINUED)**

**Electrical Characteristics:**  $V_{IN} = V_{OUT} + 1V$ ;  $I_L = 100 \mu A$ ;  $C_L = 3.3 \mu F$ ;  $V_{EN} \geq 2.0V$ ;  $T_J = +25^\circ C$ , **bold** values indicate  $-40^\circ C \leq T_J \leq +85^\circ C$ ; unless noted.

| Parameter  | Symbol                    | Min.         | Typ.  | Max.         | Units           | Conditions |
|--|---------------------------|--------------|-------|--------------|-----------------|------------|
| <b>Reference (MIC5201 Adjustable Version Only)</b> |                           |              |       |              |                 |            |
| Reference Voltage                                  | $V_{REF}$                 | 1.223        | 1.242 | 1.255        | V               | —          |
|  |                           | <b>1.217</b> | —     | <b>1.267</b> |                 |            |
| Reference Voltage Temperature Coefficient          | $\Delta V_{REF}/\Delta T$ | —            | 20    | —            | ppm/ $^\circ C$ | —          |

- Note 1:** Specification for packaged product only. Devices are ESD sensitive. Handling precautions recommended.
- Output voltage temperature coefficient is defined as the worst-case voltage change divided by the total temperature range.
  - Regulation is measured at constant junction temperature using low duty cycle pulse testing. Parts are tested for load regulation in the load range from 0.1 mA to 200 mA. Changes in output voltage due to heating effects are covered by the thermal regulation specification.
  - Dropout Voltage is defined as the input to output differential at which the output voltage drops 2% below its nominal value measured at 1V differential.
  - Ground pin current is the regulator quiescent current plus pass transistor base current. The total current drawn from the supply is the sum of the load current plus the ground pin current.
  - Thermal regulation is defined as the change in output voltage at a time “t” after a change in power dissipation is applied, excluding load or line regulation effects. Specifications are for a 200 mA load pulse at  $V_{IN} = 26V$  for fixed and  $V_{IN} = 16V$  for adjustable at  $t = 10 \text{ ms}$ .

# MIC5201

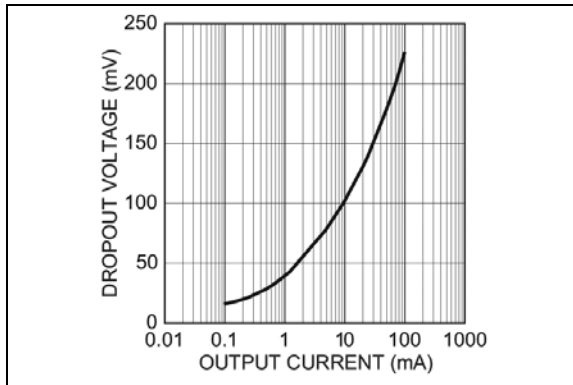
## TEMPERATURE SPECIFICATIONS (Note 1)

| Parameters                        | Sym.          | Min. | Typ. | Max. | Units | Conditions  |
|-----------------------------------|---------------|------|------|------|-------|---|
| <b>Temperature Ranges</b>         |               |      |      |      |       |   |
| Storage Temperature Range         | $T_J$         | -40  | —    | +125 | °C    | —   |
| Lead Temperature                  | —             | —    | —    | +260 | °C    | Soldering, 5 sec.   |
| <b>Package Thermal Resistance</b> |               |      |      |      |       |   |
| Thermal Resistance SOT-223        | $\theta_{JC}$ | —    | 15   | —    | °C/W  | See <a href="#">Thermal Considerations Layout</a> for more information. |
|                                   | $\theta_{JA}$ | —    | 62   | —    |       |   |
| Thermal Resistance 8-Ld SOIC      | $\theta_{JA}$ | —    | 160  | —    | °C/W  | See <a href="#">Thermal Considerations Layout</a> for more information. |

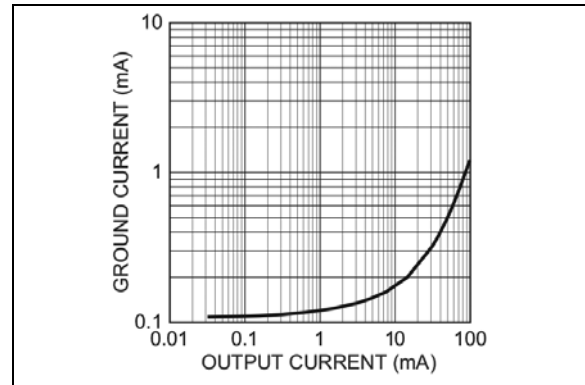
**Note 1:** The maximum allowable power dissipation is a function of ambient temperature, the maximum allowable junction temperature and the thermal resistance from junction to air (i.e.,  $T_A$ ,  $T_J$ ,  $\theta_{JA}$ ). Exceeding the maximum allowable power dissipation will cause the device operating junction temperature to exceed the maximum +125°C rating. Sustained junction temperatures above +125°C can impact the device reliability.

## 2.0 TYPICAL PERFORMANCE CURVES

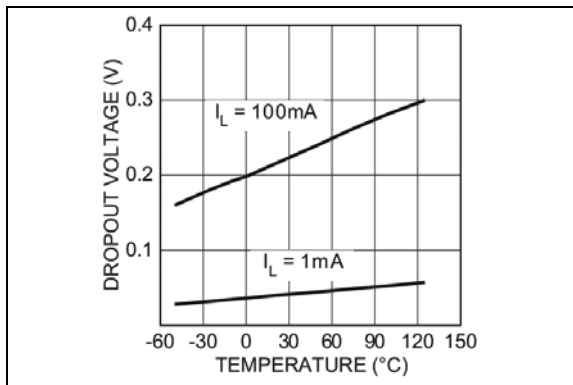
**Note:** The graphs and tables provided following this note are a statistical summary based on a limited number of samples and are provided for informational purposes only. The performance characteristics listed herein are not tested or guaranteed. In some graphs or tables, the data presented may be outside the specified operating range (e.g., outside specified power supply range) and therefore outside the warranted range.



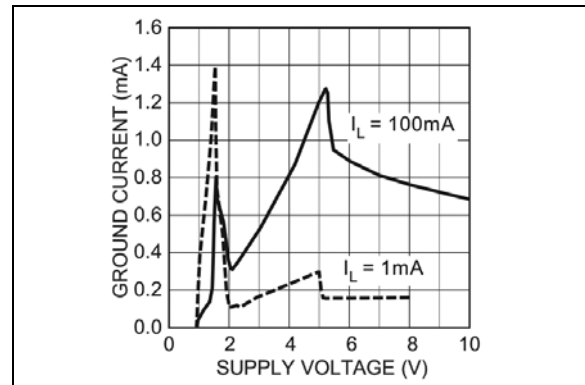
**FIGURE 2-1:** Dropout Voltage vs. Output Current.



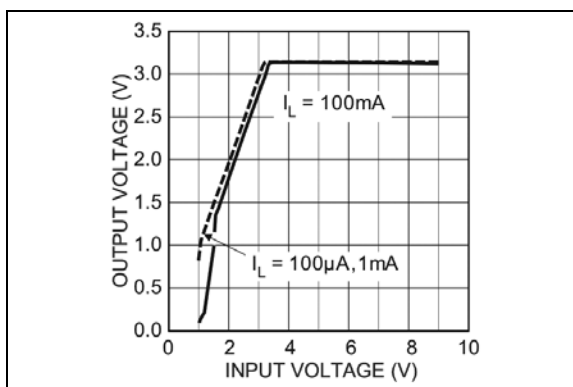
**FIGURE 2-4:** Ground Current vs. Output Current.



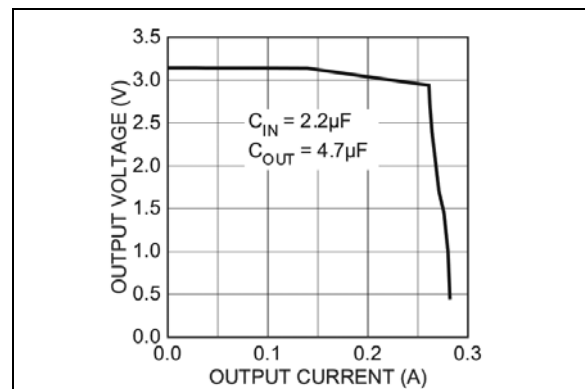
**FIGURE 2-2:** Dropout Voltage vs. Temperature.



**FIGURE 2-5:** Ground Current vs. Supply Voltage.

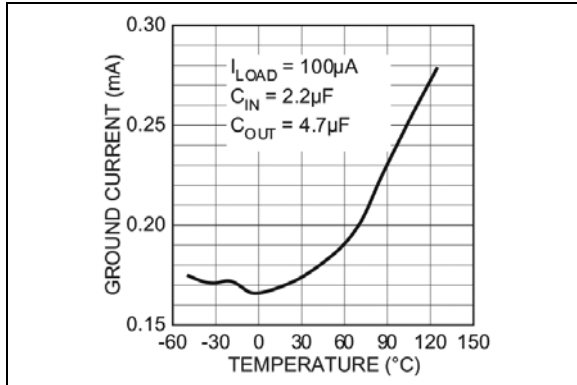


**FIGURE 2-3:** Dropout Characteristics.

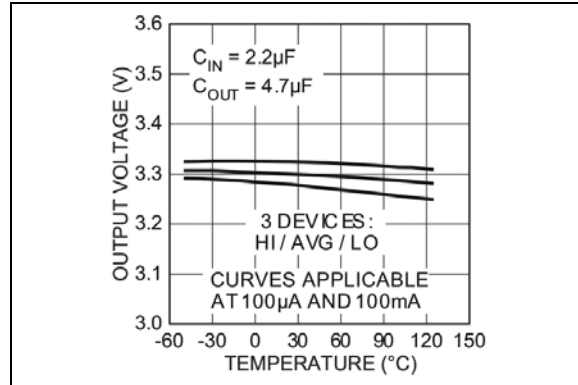


**FIGURE 2-6:** Output Voltage vs. Output Current.

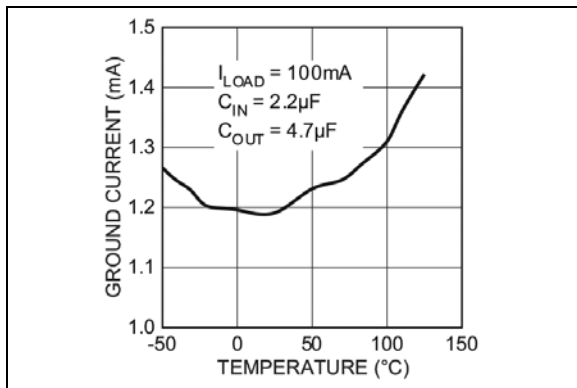
# MIC5201



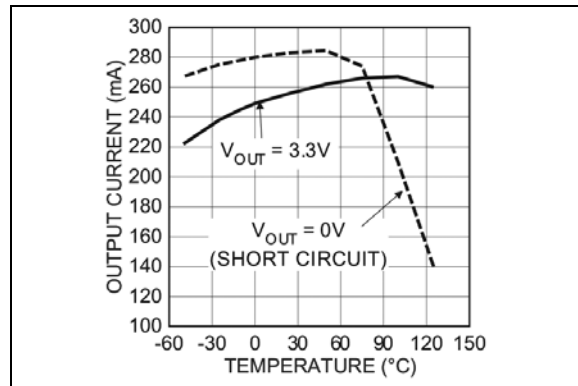
**FIGURE 2-7:** Ground Current vs. Temperature.



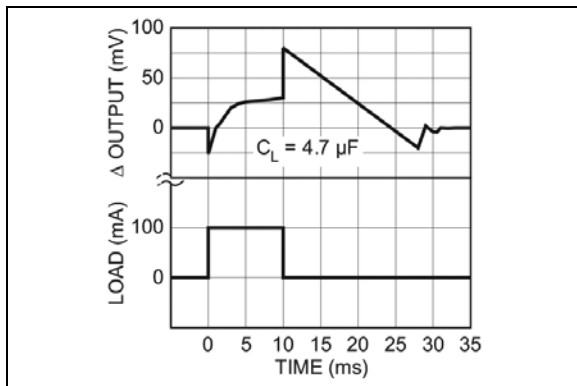
**FIGURE 2-10:** Output Voltage vs. Temperature (3.3V Version).



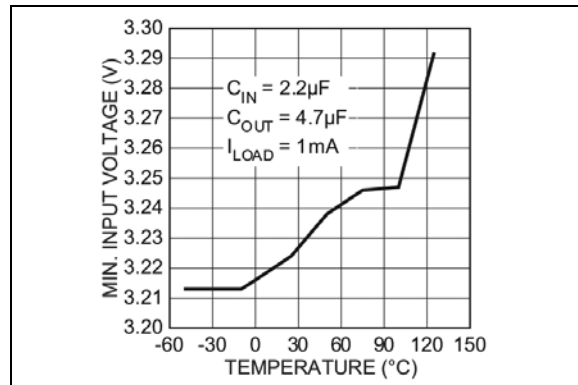
**FIGURE 2-8:** Ground Current vs. Temperature.



**FIGURE 2-11:** Output Current vs. Temperature.

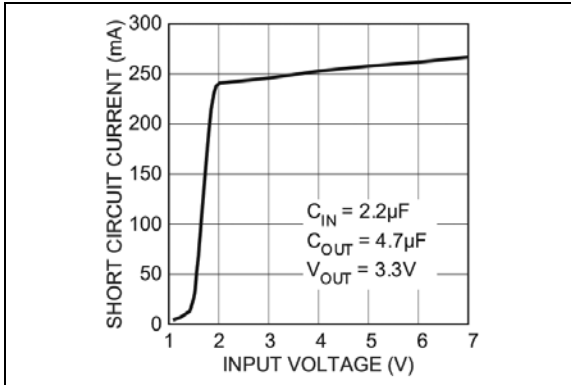


**FIGURE 2-9:** Thermal Regulation (3.3V Version).

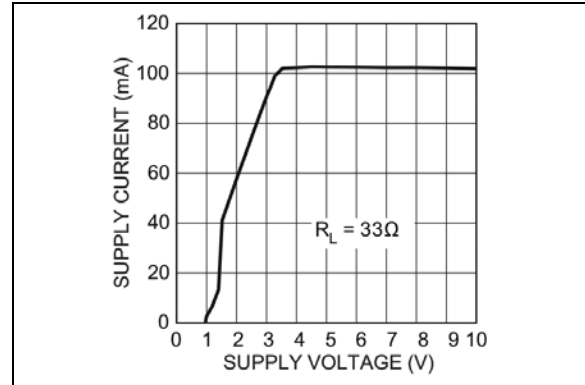


**FIGURE 2-12:** Minimum Input Voltage vs. Temperature.

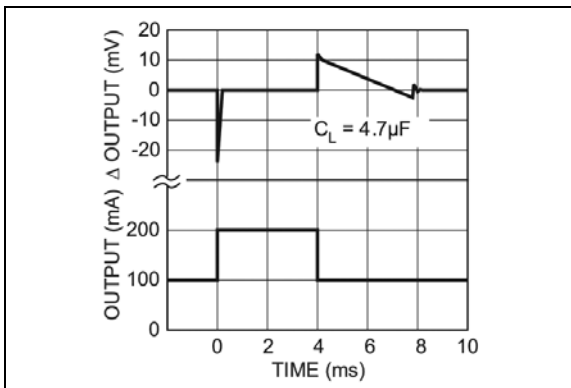




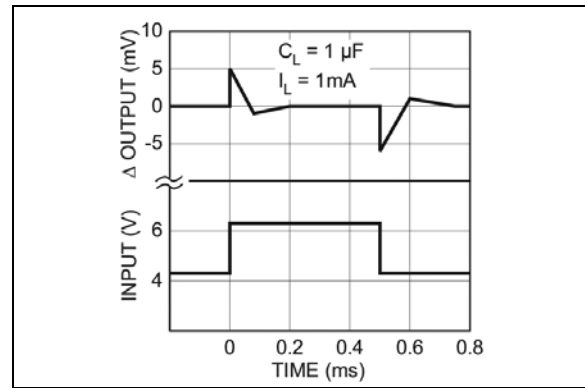
**FIGURE 2-13:** Short-Circuit Current vs. Input Voltage.



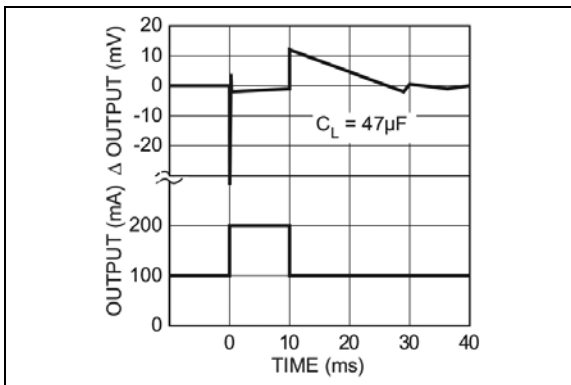
**FIGURE 2-16:** Supply Current vs. Supply Voltage (3.3V Version).



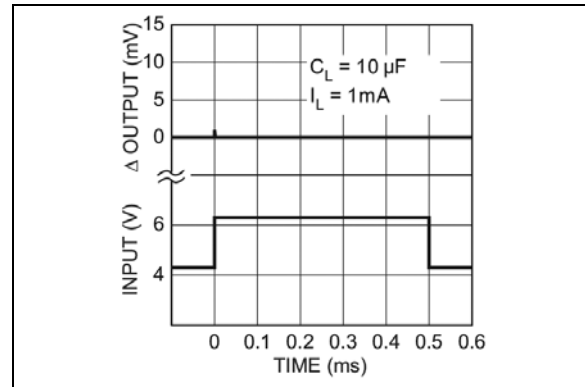
**FIGURE 2-14:** Load Transient.



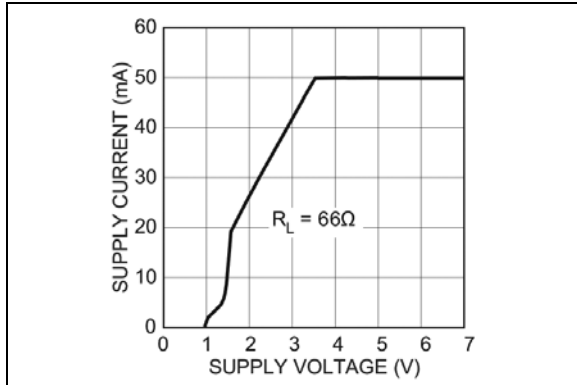
**FIGURE 2-17:** Line Transient.



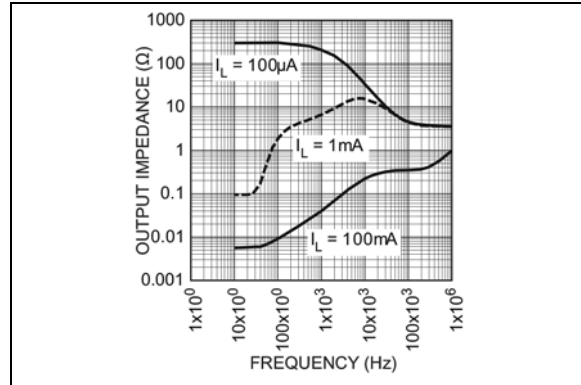
**FIGURE 2-15:** Load Transient.



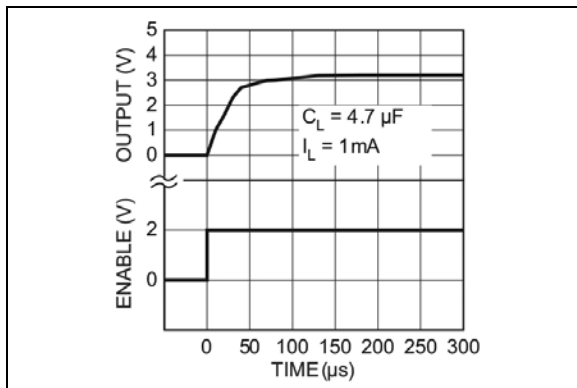
**FIGURE 2-18:** Line Transient.



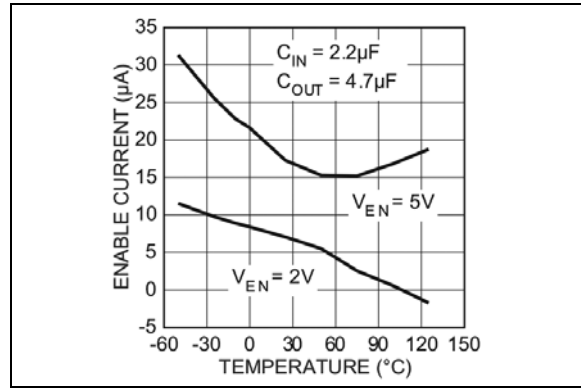
**FIGURE 2-19:** Supply Current vs. Supply Voltage (3.3V Version).



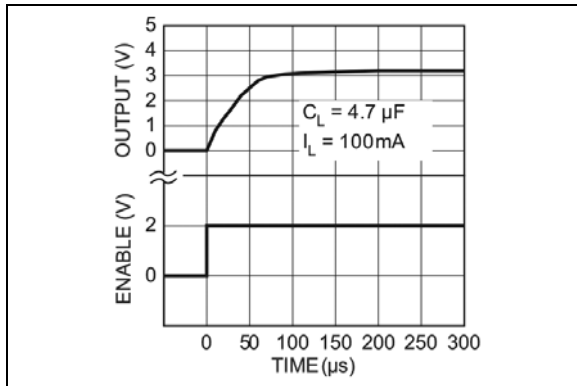
**FIGURE 2-22:** Output Impedance.



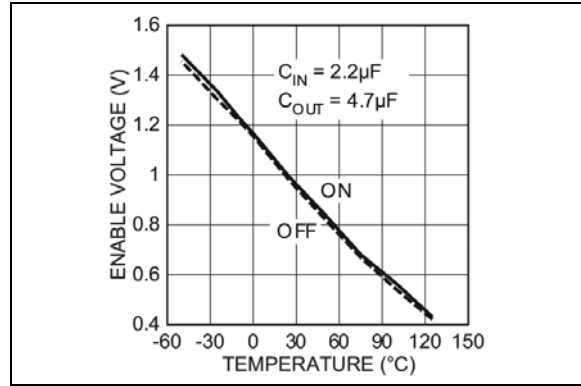
**FIGURE 2-20:** Enable Transient (3.3V Version).



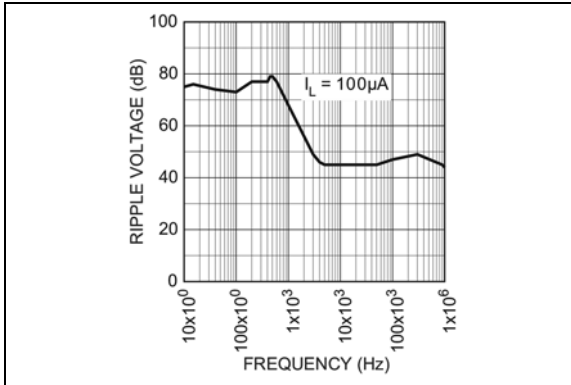
**FIGURE 2-23:** Enable Current Threshold vs. Temperature.



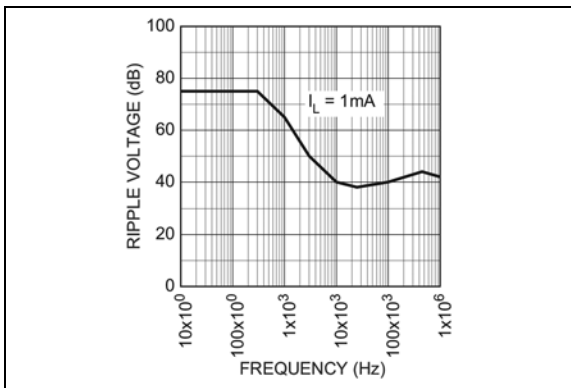
**FIGURE 2-21:** Enable Transient (3.3V Version).



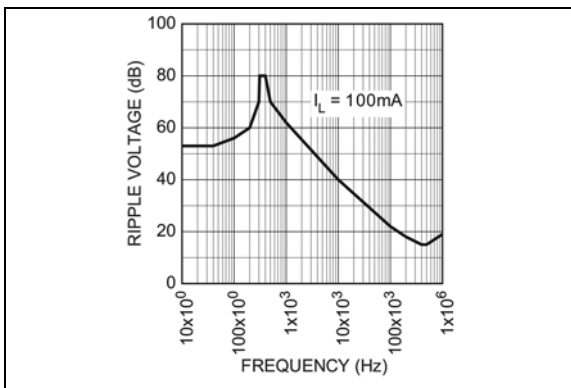
**FIGURE 2-24:** Enable Voltage Threshold vs. Temperature.



**FIGURE 2-25:** *Ripple vs. Frequency.*



**FIGURE 2-26:** *Ripple vs. Frequency.*



**FIGURE 2-27:** *Ripple vs. Frequency.*

# MIC5201

---

## 3.0 PIN DESCRIPTIONS

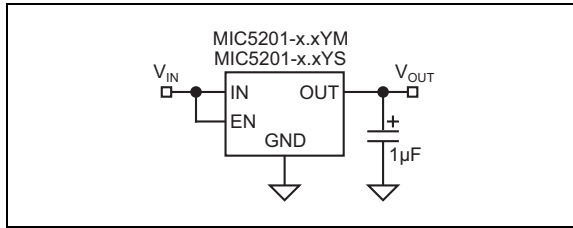
The descriptions of the pins are listed in [Table 3-1](#).

**TABLE 3-1: PIN FUNCTION TABLE**

| Pin Number<br>SOT-223 | Pin Number<br>SOIC-8 (Adj.) | Pin Number<br>SOIC-8<br>(Fixed) | Pin Name        | Description  |
|-----------------------|-----------------------------|---------------------------------|-----------------|--|
| 3                     | 1                           | 1                               | OUT             | Regulated output.  |
| —                     | 2                           | —                               | ADJ             | Feedback input. Adjustable version only.   |
| —                     | 4, 6, 7                     | 2, 4, 6, 7                      | NC              | Not internally connected. Connect to ground plane for lowest thermal resistance. |
| 2                     | 3                           | 3                               | GND             | Ground.  |
| —                     | 5                           | 5                               | EN              | Enable (input): TTL-compatible input. High = enable. Low or open = off/disable.  |
| 1                     | 8                           | 8                               | V <sub>IN</sub> | Unregulated supply input.  |

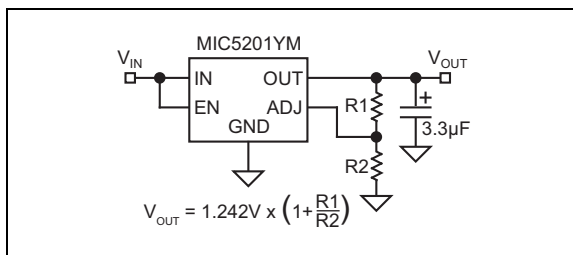
## 4.0 APPLICATIONS INFORMATION

Figure 4-1 shows a basic fixed-voltage application with the unused enable input connected to  $V_{IN}$ .



**FIGURE 4-1:** Fixed Application.

Adjustable regulators require two resistors to set the output voltage. See Figure 4-2.



**FIGURE 4-2:** Adjustable Application.

Resistor values are not critical because ADJ (adjust) has a high impedance, but for best results use resistors of 470 kΩ or less.

### 4.1 Output Capacitors

A 1 µF capacitor is recommended between the MIC5201 output and ground to prevent oscillations due to instability. Larger values serve to improve the regulator's transient response. Most types of tantalum or aluminum electrolytics will be adequate; film types will work, but are costly and therefore not recommended. Many aluminum electrolytics have electrolytes that freeze at about  $-30^{\circ}\text{C}$ , so solid tantalums are recommended for operation below  $-25^{\circ}\text{C}$ . The important parameters of the capacitor are an effective series resistance of about 5Ω or less and a resonant frequency above 500 kHz. The value of this capacitor may be increased without limit.

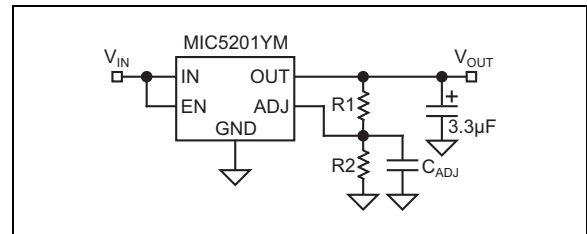
At lower values of output current, less output capacitance is required for output stability. The capacitor can be reduced to 0.47 µF for current below 10 mA or 0.33 µF for currents below 1 mA.

### 4.2 Input Capacitors

A 1 µF capacitor should be placed from the MIC5201 input to ground if there is more than 10 inches of wire between the input and the AC filter capacitor or if a battery is used as the input.

### 4.3 Noise Reduction Capacitors

On adjustable devices, a capacitor from ADJ to GND will decrease high-frequency noise on the output. See Figure 4-3.



**FIGURE 4-3:** Decreasing Output Noise.

### 4.4 Minimum Load

The MIC5201 will remain stable and in regulation with no load unlike many other voltage regulators. This is especially important in CMOS RAM keep-alive applications.

### 4.5 Dual-Supply Systems

When used in dual supply systems where the regulator load is returned to a negative supply, the output voltage must be diode clamped to ground.

### 4.6 Thermal Considerations Layout

The MIC5201-x.xYM (8-pin surface mount package) has the following thermal characteristics when mounted on a single layer copper-clad printed circuit board.

**TABLE 4-1: THERMAL CHARACTERISTICS**

| PCB Dielectric | $\theta_{JA}$ |
|----------------|---------------|
| FR4            | 160°C/W       |
| Ceramic        | 120°C/W       |

Multilayer boards having a ground plane, wide traces near the pads, and large supply bus lines provide better thermal conductivity.

The “worst case” value of 160°C/W assumes no ground plane, minimum trace widths, and a FR4 material board.

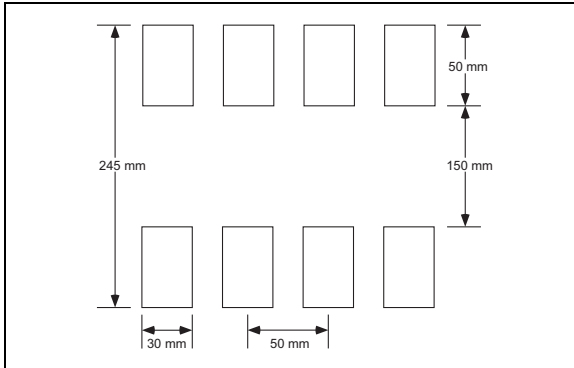
### 4.7 Nominal Power Dissipation and Die Temperature

The MIC5201-x.xYM at a  $+25^{\circ}\text{C}$  ambient temperature will operate reliably at up to 625 mW power dissipation when mounted in the “worst case” manner described above. At an ambient temperature of  $+55^{\circ}\text{C}$ , the device may safely dissipate 440 mW. These power levels are equivalent to a die temperature of  $+125^{\circ}\text{C}$ , the recommended maximum temperature for non-military grade silicon integrated circuits.

# MIC5201

---

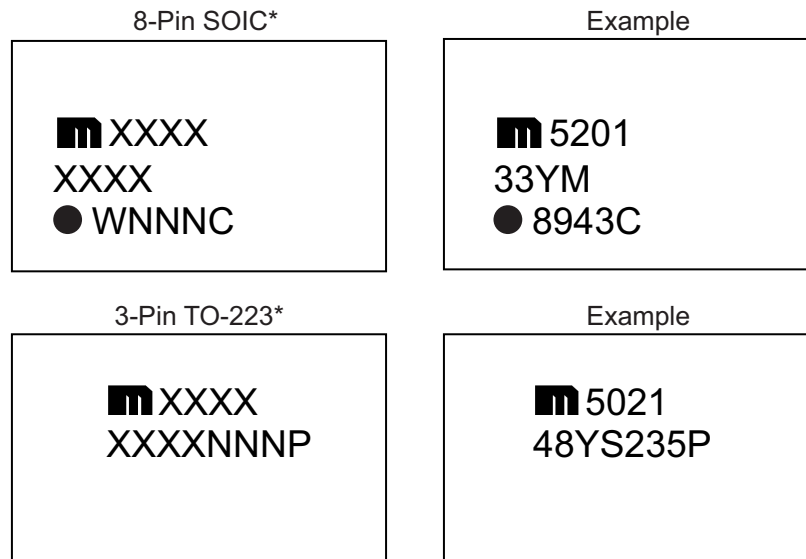
For MIC5201-x.xYS (SOT-223 package) heat sink characteristics, please refer to [Application Hint 17, P.C. Board Heat Sinking](#).



**FIGURE 4-4:** Minimum Recommended SOIC-8 PCB Pads Size.

## 5.0 PACKAGING INFORMATION

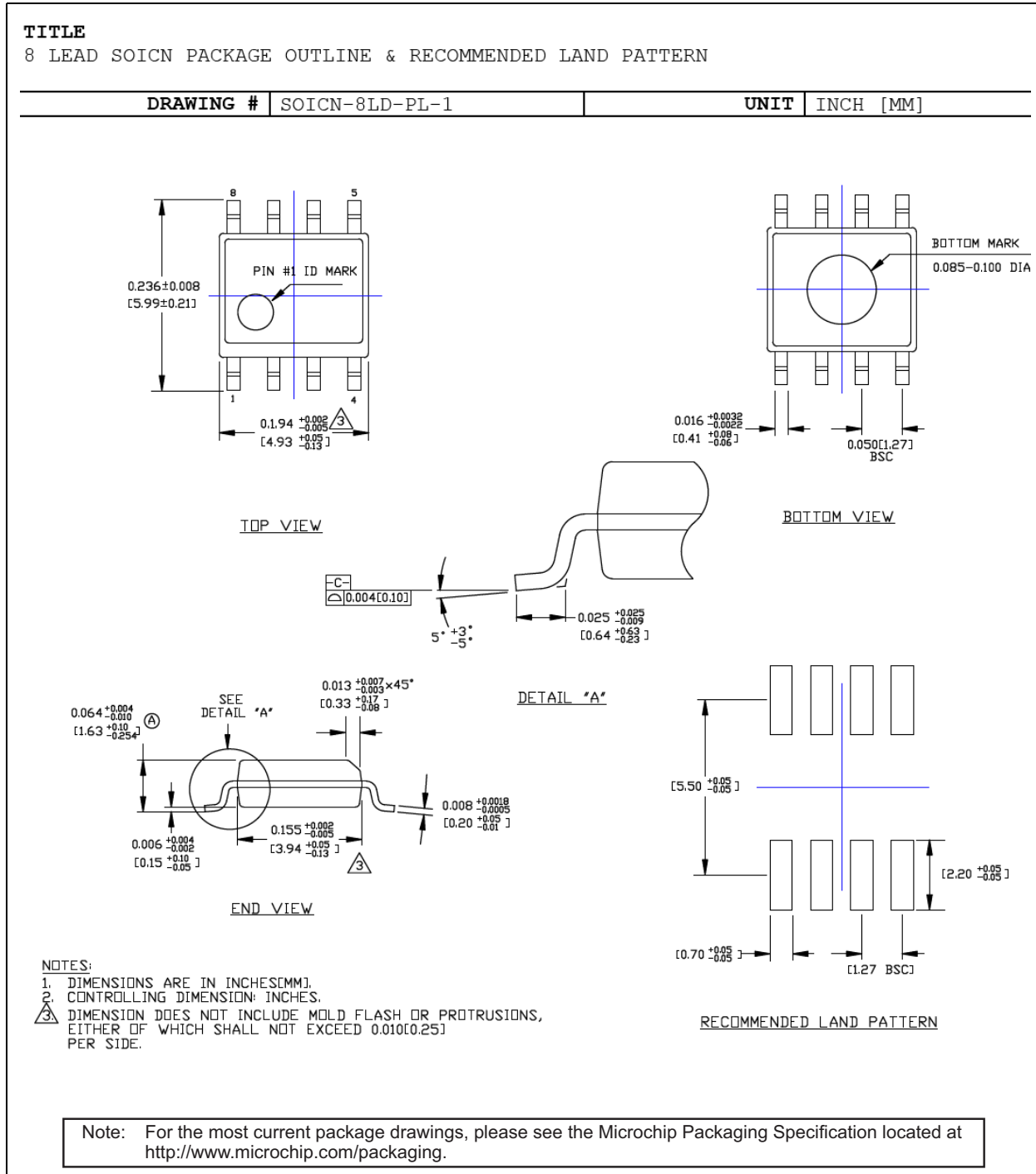
### 5.1 Package Marking Information



|   |
|---|
| <p><b>Legend:</b></p> <p>XX...X Product code or customer-specific information</p> <p>Y Year code (last digit of calendar year)</p> <p>YY Year code (last 2 digits of calendar year)</p> <p>WW Week code (week of January 1 is week '01')</p> <p>NNN Alphanumeric traceability code</p> <p>Ⓔ Pb-free JEDEC<sup>®</sup> designator for Matte Tin (Sn)</p> <p>* This package is Pb-free. The Pb-free JEDEC designator (Ⓔ3) can be found on the outer packaging for this package.</p> <p>●, ▲, ▼ Pin one index is identified by a dot, delta up, or delta down (triangle mark).</p> |
| <p><b>Note:</b> In the event the full Microchip part number cannot be marked on one line, it will be carried over to the next line, thus limiting the number of available characters for customer-specific information. Package may or may not include the corporate logo.</p> <p>Underbar ( _ ) and/or Overbar ( ¯ ) symbol may not be to scale.</p>   |

# MIC5201

## 8-Lead SOIC Package Outline and Recommended Land Pattern



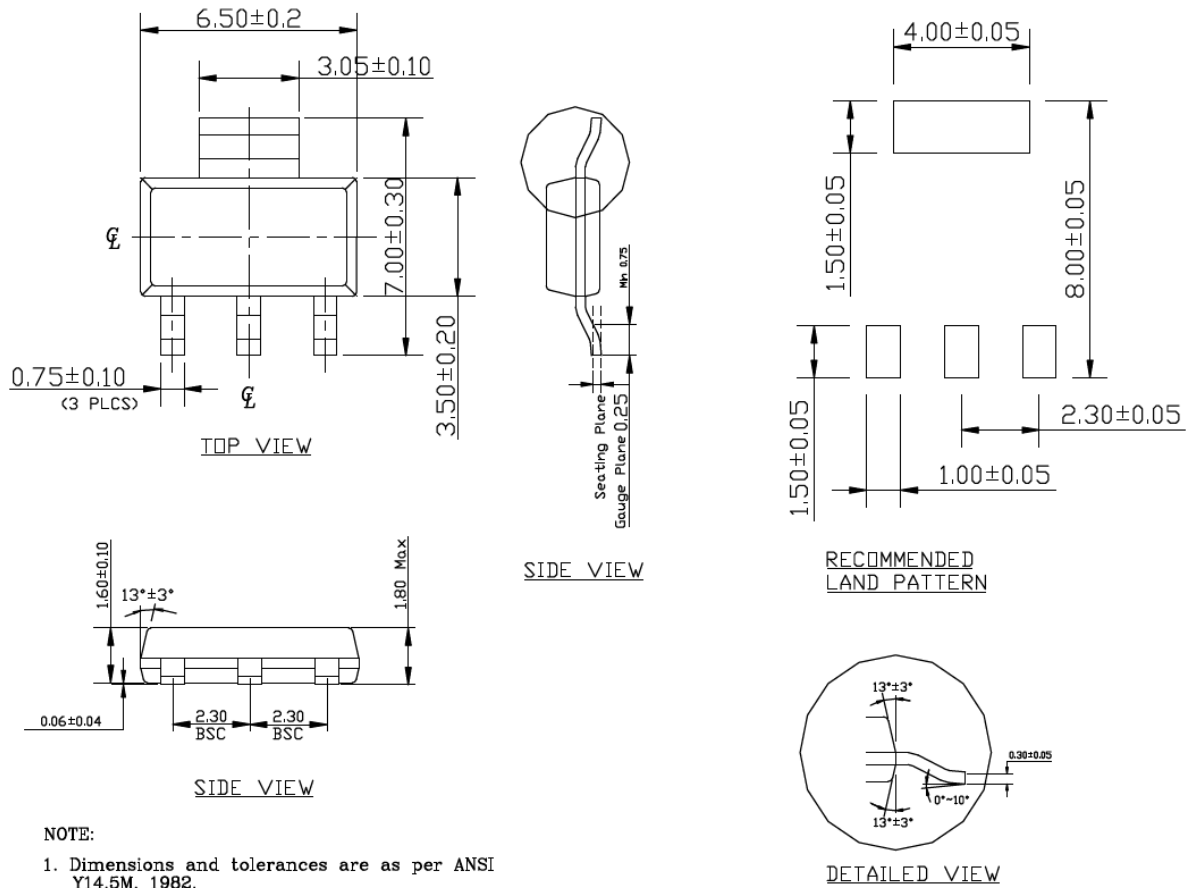


## 3-Lead TO-223 Package Outline and Recommended Land Pattern

**TITLE**

3 LEAD SOT223 PACKAGE OUTLINE & RECOMMENDED LAND PATTERN

| DRAWING # | SOT223-3LD-PL-1 | UNIT | MM |
|-----------|-----------------|------|----|
|-----------|-----------------|------|----|



**NOTE:**

1. Dimensions and tolerances are as per ANSI Y14.5M, 1982.
2. Controlling dimension: Millimeters.
3. Dimensions are exclusive of mold flash and gate burr.
4. All specification comply to Jedec spec TO261 Issue C.

Note: For the most current package drawings, please see the Microchip Packaging Specification located at <http://www.microchip.com/packaging>.

# MIC5201

---

NOTES:

## APPENDIX A: REVISION HISTORY

### Revision A (February 2017)

- Converted Micrel document MIC5201 to Microchip data sheet DS20005718A.
- Minor text changes throughout.
- Removed all reference to discontinued leaded parts.
- Added  $\theta_{JA}$  value for SOT-223 package in Temperature Specifications section.

# MIC5201

---

NOTES:

## PRODUCT IDENTIFICATION SYSTEM

To order or obtain information, e.g., on pricing or delivery, contact your local Microchip representative or sales office.

| <u>PART NO.</u>   | - | <u>XX</u>         | <u>X</u>  | <u>X</u> | - | <u>XX</u>  |
|---|---|-------------------|---|----------|---|------------|
| Device  |   | Voltage           | Junction<br>Temperature Range   | Package  |   | Media Type |
| <b>Device:</b>  |   | MIC5201:          | 200 mA Low Dropout Regulator  |          |   |            |
| <b>Voltage:</b>   |   | (blank) =         | Adjustable (M package only)   |          |   |            |
|   |   | 3.0               | = 3.0V  |          |   |            |
|   |   | 3.3               | = 3.3V  |          |   |            |
|   |   | 4.8               | = 4.8V (S package only)   |          |   |            |
|   |   | 5.0               | = 5.0V  |          |   |            |
| <b>Junction<br/>Temperature<br/>Range:</b>  |   | Y                 | = -40°C to +125°C   |          |   |            |
| <b>Package:</b>   |   | M                 | = 8-Lead SOIC   |          |   |            |
|   |   | S                 | = 3-Lead SOT-223  |          |   |            |
| <b>Media Type:</b>  |   | TR                | = 2,500/Reel  |          |   |            |
|   |   | (blank)           | = 95/Tube for M Package   |          |   |            |
|   |   | (blank)           | = 78/Tube for S Package   |          |   |            |
| <b>Examples:</b>  |   |                   |   |          |   |            |
| a)  |   | MIC5201YM:        | 200 mA Low Dropout Regulator<br>Adjustable Voltage, 8-Lead<br>SOIC, -40°C to +125°C<br>Junction Temperature Range,<br>95/Tube |          |   |            |
| b)  |   | MIC5201-3.0YM-TR: | 200 mA Low Dropout Regulator<br>3.0V Voltage, 8-Lead SOIC,<br>-40°C to +125°C Junction<br>Temperature Range,<br>2,500/Reel    |          |   |            |
| c)  |   | MIC5201-3.3YM:    | 200 mA Low Dropout Regulator<br>3.3V Voltage, 8-Lead SOIC,<br>-40°C to +125°C Junction<br>Temperature Range,<br>95/Tube       |          |   |            |
| d)  |   | MIC5201-5.0YM-TR: | 200 mA Low Dropout Regulator<br>5.0V Voltage, 8-Lead SOIC,<br>-40°C to +125°C Junction<br>Temperature Range,<br>2,500/Reel    |          |   |            |
| e)  |   | MIC5201-3.0YS:    | 200 mA Low Dropout Regulator<br>3.0V Voltage, 3-Lead SOT-223,<br>-40°C to +125°C Junction<br>Temperature Range,<br>78/Tube    |          |   |            |
| f)  |   | MIC5201-3.3YS-TR: | 200 mA Low Dropout Regulator<br>3.3V Voltage, 3-Lead SOT-223,<br>-40°C to +125°C Junction<br>Temperature Range,<br>2,500/Reel |          |   |            |
| g)  |   | MIC5201-4.8YS:    | 200 mA Low Dropout Regulator<br>4.8V Voltage, 3-Lead SOT-223,<br>-40°C to +125°C Junction<br>Temperature Range,<br>78/Tube    |          |   |            |
| h)  |   | MIC5201-5.0YS-TR: | 200 mA Low Dropout Regulator<br>5.0V Voltage, 3-Lead SOT-223,<br>-40°C to +125°C Junction<br>Temperature Range,<br>2,500/Reel |          |   |            |
| <b>Note 1:</b> Tape and Reel identifier only appears in the catalog part number description. This identifier is used for ordering purposes and is not printed on the device package. Check with your Microchip Sales Office for package availability with the Tape and Reel option. |   |                   |   |          |   |            |

# MIC5201

---

NOTES:

---

---

**Note the following details of the code protection feature on Microchip devices:**

- Microchip products meet the specification contained in their particular Microchip Data Sheet.
- Microchip believes that its family of products is one of the most secure families of its kind on the market today, when used in the intended manner and under normal conditions.
- There are dishonest and possibly illegal methods used to breach the code protection feature. All of these methods, to our knowledge, require using the Microchip products in a manner outside the operating specifications contained in Microchip's Data Sheets. Most likely, the person doing so is engaged in theft of intellectual property.
- Microchip is willing to work with the customer who is concerned about the integrity of their code.
- Neither Microchip nor any other semiconductor manufacturer can guarantee the security of their code. Code protection does not mean that we are guaranteeing the product as “unbreakable.”

Code protection is constantly evolving. We at Microchip are committed to continuously improving the code protection features of our products. Attempts to break Microchip's code protection feature may be a violation of the Digital Millennium Copyright Act. If such acts allow unauthorized access to your software or other copyrighted work, you may have a right to sue for relief under that Act.

---

Information contained in this publication regarding device applications and the like is provided only for your convenience and may be superseded by updates. It is your responsibility to ensure that your application meets with your specifications. MICROCHIP MAKES NO REPRESENTATIONS OR WARRANTIES OF ANY KIND WHETHER EXPRESS OR IMPLIED, WRITTEN OR ORAL, STATUTORY OR OTHERWISE, RELATED TO THE INFORMATION, INCLUDING BUT NOT LIMITED TO ITS CONDITION, QUALITY, PERFORMANCE, MERCHANTABILITY OR FITNESS FOR PURPOSE. Microchip disclaims all liability arising from this information and its use. Use of Microchip devices in life support and/or safety applications is entirely at the buyer's risk, and the buyer agrees to defend, indemnify and hold harmless Microchip from any and all damages, claims, suits, or expenses resulting from such use. No licenses are conveyed, implicitly or otherwise, under any Microchip intellectual property rights unless otherwise stated.

*Microchip received ISO/TS-16949:2009 certification for its worldwide headquarters, design and wafer fabrication facilities in Chandler and Tempe, Arizona; Gresham, Oregon and design centers in California and India. The Company's quality system processes and procedures are for its PIC® MCUs and dsPIC® DSCs, KEELoC® code hopping devices, Serial EEPROMs, microperipherals, nonvolatile memory and analog products. In addition, Microchip's quality system for the design and manufacture of development systems is ISO 9001:2000 certified.*

**QUALITY MANAGEMENT SYSTEM  
CERTIFIED BY DNV  
= ISO/TS 16949 =**

### Trademarks

The Microchip name and logo, the Microchip logo, AnyRate, AVR, AVR logo, AVR Freaks, BeaconThings, BitCloud, CryptoMemory, CryptoRF, dsPIC, FlashFlex, flexPWR, Heldo, JukeBlox, KEELoC, KEELoC logo, Klear, LANCheck, LINK MD, maXStylus, maXTouch, MediaLB, megaAVR, MOST, MOST logo, MPLAB, OptoLyzer, PIC, picoPower, PICSTART, PIC32 logo, Prochip Designer, QTouch, RightTouch, SAM-BA, SpyNIC, SST, SST Logo, SuperFlash, tinyAVR, UNI/O, and XMEGA are registered trademarks of Microchip Technology Incorporated in the U.S.A. and other countries.

ClockWorks, The Embedded Control Solutions Company, EtherSynch, Hyper Speed Control, HyperLight Load, IntelliMOS, mTouch, Precision Edge, and Quiet-Wire are registered trademarks of Microchip Technology Incorporated in the U.S.A.

Adjacent Key Suppression, AKS, Analog-for-the-Digital Age, Any Capacitor, AnyIn, AnyOut, BodyCom, chipKIT, chipKIT logo, CodeGuard, CryptoAuthentication, CryptoCompanion, CryptoController, dsPICDEM, dsPICDEM.net, Dynamic Average Matching, DAM, ECAN, EtherGREEN, In-Circuit Serial Programming, ICSP, Inter-Chip Connectivity, JitterBlocker, KlearNet, KlearNet logo, Mindi, MiWi, motorBench, MPASM, MPF, MPLAB Certified logo, MPLIB, MPLINK, MultiTRAK, NetDetach, Omniscient Code Generation, PICDEM, PICDEM.net, PICKit, PICTail, PureSilicon, QMatrix, RightTouch logo, REAL ICE, Ripple Blocker, SAM-ICE, Serial Quad I/O, SMART-I.S., SQI, SuperSwitcher, SuperSwitcher II, Total Endurance, TSHARC, USBCheck, VariSense, ViewSpan, WiperLock, Wireless DNA, and ZENA are trademarks of Microchip Technology Incorporated in the U.S.A. and other countries.

SQTP is a service mark of Microchip Technology Incorporated in the U.S.A.

Silicon Storage Technology is a registered trademark of Microchip Technology Inc. in other countries.

GestIC is a registered trademark of Microchip Technology Germany II GmbH & Co. KG, a subsidiary of Microchip Technology Inc., in other countries.

All other trademarks mentioned herein are property of their respective companies.

© 2017, Microchip Technology Incorporated, All Rights Reserved.  
ISBN: 978-1-5224-1407-0



# MICROCHIP

## Worldwide Sales and Service

### AMERICAS

#### Corporate Office

2355 West Chandler Blvd.  
Chandler, AZ 85224-6199

Tel: 480-792-7200

Fax: 480-792-7277

Technical Support:

[http://www.microchip.com/  
support](http://www.microchip.com/support)

Web Address:

[www.microchip.com](http://www.microchip.com)

#### Atlanta

Duluth, GA

Tel: 678-957-9614

Fax: 678-957-1455

#### Austin, TX

Tel: 512-257-3370

#### Boston

Westborough, MA

Tel: 774-760-0087

Fax: 774-760-0088

#### Chicago

Itasca, IL

Tel: 630-285-0071

Fax: 630-285-0075

#### Dallas

Addison, TX

Tel: 972-818-7423

Fax: 972-818-2924

#### Detroit

Novi, MI

Tel: 248-848-4000

#### Houston, TX

Tel: 281-894-5983

#### Indianapolis

Noblesville, IN

Tel: 317-773-8323

Fax: 317-773-5453

Tel: 317-536-2380

#### Los Angeles

Mission Viejo, CA

Tel: 949-462-9523

Fax: 949-462-9608

Tel: 951-273-7800

#### Raleigh, NC

Tel: 919-844-7510

#### New York, NY

Tel: 631-435-6000

#### San Jose, CA

Tel: 408-735-9110

Tel: 408-436-4270

#### Canada - Toronto

Tel: 905-695-1980

Fax: 905-695-2078

### ASIA/PACIFIC

#### Asia Pacific Office

Suites 3707-14, 37th Floor  
Tower 6, The Gateway  
Harbour City, Kowloon

#### Hong Kong

Tel: 852-2943-5100

Fax: 852-2401-3431

#### Australia - Sydney

Tel: 61-2-9868-6733

Fax: 61-2-9868-6755

#### China - Beijing

Tel: 86-10-8569-7000

Fax: 86-10-8528-2104

#### China - Chengdu

Tel: 86-28-8665-5511

Fax: 86-28-8665-7889

#### China - Chongqing

Tel: 86-23-8980-9588

Fax: 86-23-8980-9500

#### China - Dongguan

Tel: 86-769-8702-9880

#### China - Guangzhou

Tel: 86-20-8755-8029

#### China - Hangzhou

Tel: 86-571-8792-8115

Fax: 86-571-8792-8116

#### China - Hong Kong SAR

Tel: 852-2943-5100

Fax: 852-2401-3431

#### China - Nanjing

Tel: 86-25-8473-2460

Fax: 86-25-8473-2470

#### China - Qingdao

Tel: 86-532-8502-7355

Fax: 86-532-8502-7205

#### China - Shanghai

Tel: 86-21-3326-8000

Fax: 86-21-3326-8021

#### China - Shenyang

Tel: 86-24-2334-2829

Fax: 86-24-2334-2393

#### China - Shenzhen

Tel: 86-755-8864-2200

Fax: 86-755-8203-1760

#### China - Wuhan

Tel: 86-27-5980-5300

Fax: 86-27-5980-5118

#### China - Xian

Tel: 86-29-8833-7252

Fax: 86-29-8833-7256

### ASIA/PACIFIC

#### China - Xiamen

Tel: 86-592-2388138

Fax: 86-592-2388130

#### China - Zhuhai

Tel: 86-756-3210040

Fax: 86-756-3210049

#### India - Bangalore

Tel: 91-80-3090-4444

Fax: 91-80-3090-4123

#### India - New Delhi

Tel: 91-11-4160-8631

Fax: 91-11-4160-8632

#### India - Pune

Tel: 91-20-3019-1500

#### Japan - Osaka

Tel: 81-6-6152-7160

Fax: 81-6-6152-9310

#### Japan - Tokyo

Tel: 81-3-6880-3770

Fax: 81-3-6880-3771

#### Korea - Daegu

Tel: 82-53-744-4301

Fax: 82-53-744-4302

#### Korea - Seoul

Tel: 82-2-554-7200

Fax: 82-2-558-5932 or

82-2-558-5934

#### Malaysia - Kuala Lumpur

Tel: 60-3-6201-9857

Fax: 60-3-6201-9859

#### Malaysia - Penang

Tel: 60-4-227-8870

Fax: 60-4-227-4068

#### Philippines - Manila

Tel: 63-2-634-9065

Fax: 63-2-634-9069

#### Singapore

Tel: 65-6334-8870

Fax: 65-6334-8850

#### Taiwan - Hsin Chu

Tel: 886-3-5778-366

Fax: 886-3-5770-955

#### Taiwan - Kaohsiung

Tel: 886-7-213-7830

#### Taiwan - Taipei

Tel: 886-2-2508-8600

Fax: 886-2-2508-0102

#### Thailand - Bangkok

Tel: 66-2-694-1351

Fax: 66-2-694-1350

### EUROPE

#### Austria - Wels

Tel: 43-7242-2244-39

Fax: 43-7242-2244-393

#### Denmark - Copenhagen

Tel: 45-4450-2828

Fax: 45-4485-2829

#### Finland - Espoo

Tel: 358-9-4520-820

#### France - Paris

Tel: 33-1-69-53-63-20

Fax: 33-1-69-30-90-79

#### France - Saint Cloud

Tel: 33-1-30-60-70-00

#### Germany - Garching

Tel: 49-8931-9700

#### Germany - Haan

Tel: 49-2129-3766400

#### Germany - Heilbronn

Tel: 49-7131-67-3636

#### Germany - Karlsruhe

Tel: 49-721-625370

#### Germany - Munich

Tel: 49-89-627-144-0

Fax: 49-89-627-144-44

#### Germany - Rosenheim

Tel: 49-8031-354-560

#### Israel - Ra'anana

Tel: 972-9-744-7705

#### Italy - Milan

Tel: 39-0331-742611

Fax: 39-0331-466781

#### Italy - Padova

Tel: 39-049-7625286

#### Netherlands - Drunen

Tel: 31-416-690399

Fax: 31-416-690340

#### Norway - Trondheim

Tel: 47-7289-7561

#### Poland - Warsaw

Tel: 48-22-3325737

#### Romania - Bucharest

Tel: 40-21-407-87-50

#### Spain - Madrid

Tel: 34-91-708-08-90

Fax: 34-91-708-08-91

#### Sweden - Gothenberg

Tel: 46-31-704-60-40

#### Sweden - Stockholm

Tel: 46-8-5090-4654

#### UK - Wokingham

Tel: 44-118-921-5800

Fax: 44-118-921-5820