

### General Description

The MIC5201 is an efficient linear voltage regulator with very low dropout voltage (typically 17mV at light loads and 200mV at 100mA), and very low ground current (1mA at 100mA output), offering better than 1% initial accuracy with a logic compatible on-off switching input.

Designed especially for hand-held battery powered devices, the MIC5201 can be switched by a CMOS or TTL compatible enable signal. This enable control may be connected directly to  $V_{IN}$  if unneeded. When disabled, power consumption drops nearly to zero. The ground current of the MIC5201 increases only slightly in dropout, further prolonging battery life. Key MIC5201 features include current limiting, overtemperature shutdown, and protection against reversed battery.

The MIC5201 is available in several fixed voltages and accuracy configurations. It features the same pinout as the LT1121 with better performance. Other options are available; contact Micrel for details.

### Features

- High output voltage accuracy
- Variety of output voltages
- Guaranteed 200mA output
- Low quiescent current
- Low dropout voltage
- Extremely tight load and line regulation
- Very low temperature coefficient
- Current and thermal limiting
- Reversed-battery protection
- Load-dump protection (fixed voltage versions)
- Zero off-mode current
- Logic-controlled electronic enable
- Available in SO-8 and SOT-223 packages

### Applications

- Cellular telephones
- Laptop, notebook, and palmtop computers
- Battery powered equipment
- PCMCIA  $V_{CC}$  and  $V_{PP}$  regulation/switching
- Bar code scanners
- SMPS post-regulator/ dc-to-dc modules
- High-efficiency linear power supplies

### Ordering Information

Part Number	Voltage	Junction Temp. Range*	Package
MIC5201BM	Adj	-40°C to +125°C	SO-8
MIC5201-3.0BM	3.0	-40°C to +125°C	SO-8
MIC5201-3.3BM	3.3	-40°C to +125°C	SO-8
MIC5201-5.0BM	5.0	-40°C to +125°C	SO-8
MIC5201-3.0BS	3.0	-40°C to +125°C	SOT-223
MIC5201-3.3BS	3.3	-40°C to +125°C	SOT-223
MIC5201-4.8BS	4.85	-40°C to +125°C	SOT-223
MIC5201-5.0BS	5.0	-40°C to +125°C	SOT-223

Other voltages available. Contact Micrel for details.

\* Junction Temperature.

### Typical Application

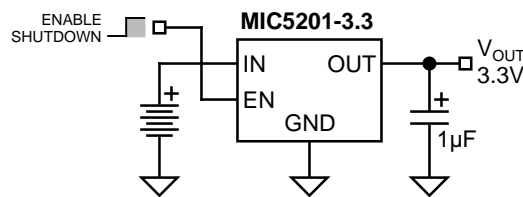

## Pin Configuration

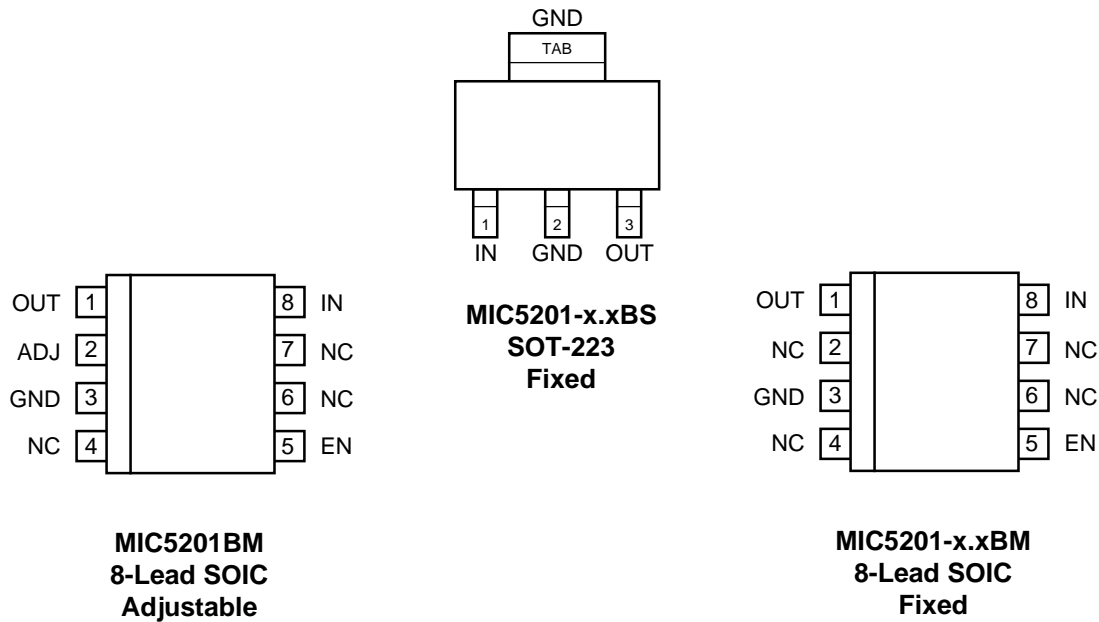

## Pin Description

Pin No. SOT-223	Pin No. SO-8 Adj.	Pin No. SO-8 Fixed	Pin Name	Pin Function
3	1	1	OUT	Regulated Output
	2		ADJ	Feedback Input: (Adjustable version only)
	4, 6, 7	2, 4, 6, 7	NC	not internally connected: Connect to ground plane for lowest thermal resistance.
2	3	3	GND	Ground
	5	5	EN	Enable (Input): TTL compatible input. High = enable. Low or open = off/disable.
1	8	8	$V_{IN}$	Unregulated Supply Input

## Absolute Maximum Ratings

Supply Input Voltage ( $V_{IN}$ ) Fixed ..... -20V to +60V  
 Supply Input Voltage ( $V_{IN}$ ) Adjustable ..... -20V to +20V  
 Enable Input Voltage ( $V_{EN}$ ) Fixed ..... -20V to +60V  
 Enable Input Voltage ( $V_{EN}$ ) Adjustable ..... -20V to +20V  
 Power Dissipation ( $P_D$ ) ..... Internally Limited  
 Junction Temperature ( $T_J$ ) ..... -40°C to +125°C  
 Lead Temperature (soldering, 5 sec.) ..... 260°C

## Operating Ratings

Supply Input Voltage ( $V_{IN}$ ) Fixed ..... 2.5V to +26V  
 Supply Input Voltage ( $V_{IN}$ ) Adjustable ..... 2.5V to +16V  
 Enable Input Voltage ( $V_{EN}$ ) ..... 0V to  $V_{IN}$   
 Junction Temperature ( $T_J$ ) ..... -40°C to +125°C

## Electrical Characteristics

$V_{IN} = V_{OUT} + 1V$ ;  $I_L = 100\mu A$ ;  $C_L = 3.3\mu F$ ;  $V_{EN} \geq 2.0V$ ;  $T_J = 25^\circ C$ , **bold** values indicate  $-40^\circ C \leq T_J \leq +85^\circ C$ ; unless noted

Symbol	Parameter	Condition	Min	Typ	Max	Units
$V_O$	Output Voltage Accuracy	Variation from specified $V_{OUT}$	-1		1	%
			-2		2	%
$\Delta V_O/\Delta T$	Output Voltage Temperature Coef.	<b>Note 2</b>		40	150	ppm/ $^\circ C$
$\Delta V_O/V_O$	Line Regulation, Fixed	$V_{IN} = V_{OUT} + 1V$ to 26V		0.004	0.20 <b>0.40</b>	% %
$\Delta V_O/V_O$	Line Regulation, Adjustable	$V_{IN} = V_{OUT} + 1V$ to 16V		0.004	0.20 <b>0.40</b>	% %
$\Delta V_O/V_O$	Load Regulation	$I_L = 0.1mA$ to 200mA, <b>Note 3</b>		0.04	0.16 <b>0.30</b>	% %
$V_{IN} - V_O$	Dropout Voltage, <b>Note 4</b>	$I_L = 100\mu A$ $I_L = 20mA$ $I_L = 50mA$ $I_L = 100mA$ $I_L = 200mA$		17		mV
				130		mV
				180		mV
				225		mV
				270	<b>400</b>	mV
$I_{GND}$	Quiescent Current	$V_{ENABLE} \leq 0.7V$ (shutdown)		0.01		$\mu A$
$I_{GND}$	Ground Pin Current	$I_L = 100\mu A$ $I_L = 20mA$ $I_L = 50mA$ $I_L = 100mA$ $I_L = 200mA$		130		$\mu A$
				270	400	$\mu A$
				500		$\mu A$
				1000	<b>2000</b>	$\mu A$
				3000		$\mu A$
PSRR	Ripple Rejection			75		dB
$I_{GNDDO}$	Ground Pin Current at Dropout	$V_{IN} = 0.5V$ less than specified $V_{OUT}$ , $I_L = 100\mu A$ , <b>Note 5</b>		270	<b>330</b>	$\mu A$
$I_{LIMIT}$	Current Limit	$V_{OUT} = 0V$		<b>280</b>	500	mA
$\Delta V_O/\Delta P_D$	Thermal Regulation	<b>Note 6</b>		0.05		%/W
$e_n$	Output Noise			100		$\mu V$

### Enable Input

$V_{IL}$	Input Voltage Level	logic low (off)			<b>0.7</b>	V
$V_{IH}$	Input Voltage Level	logic high (on)	<b>2.0</b>			V
$I_{IL}$	Enable Input Current	$V_{IL} \leq 0.7V$		0.01	<b>1</b>	$\mu A$
$I_{IH}$	Enable Input Current	$V_{IH} \leq 2.0V$		15	<b>50</b>	$\mu A$

### Reference (MIC5201 Adjustable Version Only)

$V_{REF}$	Reference Voltage		1.223	1.242	1.255	V
			<b>1.217</b>		<b>1.267</b>	V
$I_{IL}$	Reference Voltage Temp. Coef.			20		ppm/ $^\circ C$

**General Note:** Devices are ESD sensitive. Handling precautions recommended.

**Note 1:** Absolute maximum ratings indicate limits beyond which damage to the component may occur. Electrical specifications do not apply when operating the device outside of its rated operating conditions. The maximum allowable power dissipation is a function of the maximum junction temperature,  $T_{J(max)}$ , the junction-to-ambient thermal resistance,  $\theta_{JA}$ , and the ambient temperature,  $T_A$ . The maximum allowable power dissipation at any ambient temperature is calculated using:  $P_{(max)} = (T_{J(max)} - T_A) \div \theta_{JA}$ . Exceeding the maximum allowable power dissipation will result in excessive die temperature, and the regulator will go into thermal shutdown. The  $\theta_{JC}$  of the MIC5201-x.xBS is 15 $^\circ C/W$  and  $\theta_{JA}$  for the MIC5201BM is 160 $^\circ C/W$  mounted on a PC board (see "Thermal Considerations" section for further details).

**Note 2:** Output voltage temperature coefficient is defined as the worst-case voltage change divided by the total temperature range.

**Note 3:** Regulation is measured at constant junction temperature using low duty cycle pulse testing. Parts are tested for load regulation in the load range from 0.1mA to 200mA. Changes in output voltage due to heating effects are covered by the thermal regulation specification.

**Note 4:** Dropout Voltage is defined as the input to output differential at which the output voltage drops 2% below its nominal value measured at 1V differential.

**Note 5:** Ground pin current is the regulator quiescent current plus pass transistor base current. The total current drawn from the supply is the sum of the load current plus the ground pin current.

**Note 6:** Thermal regulation is defined as the change in output voltage at a time "t" after a change in power dissipation is applied, excluding load or line regulation effects. Specifications are for a 200mA load pulse at  $V_{IN} = 26V$  for fixed and  $V_{IN} = 16V$  for adjustable at  $t = 10ms$ .

# Block Diagrams

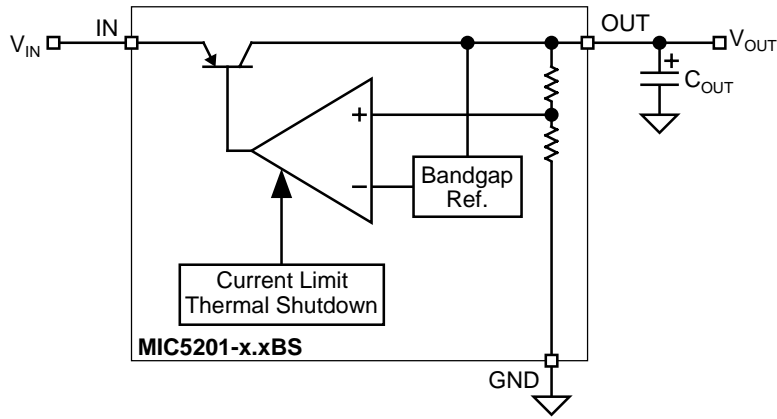

**Fixed Regulator (SOT-223 version only)**

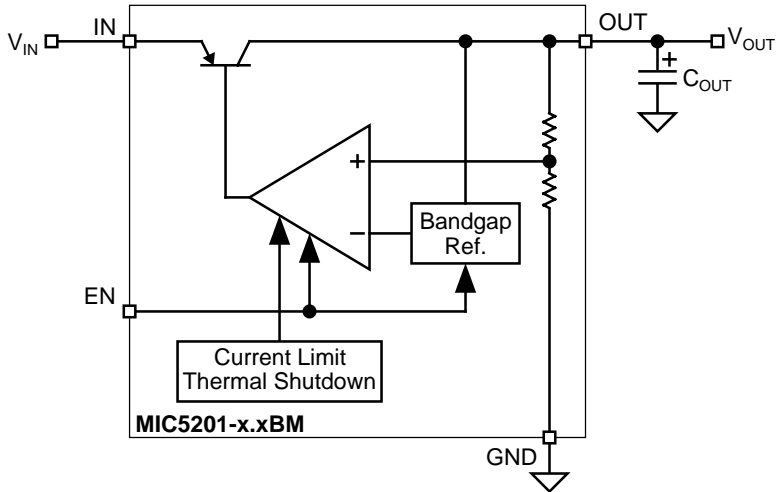

**Fixed Regulator**

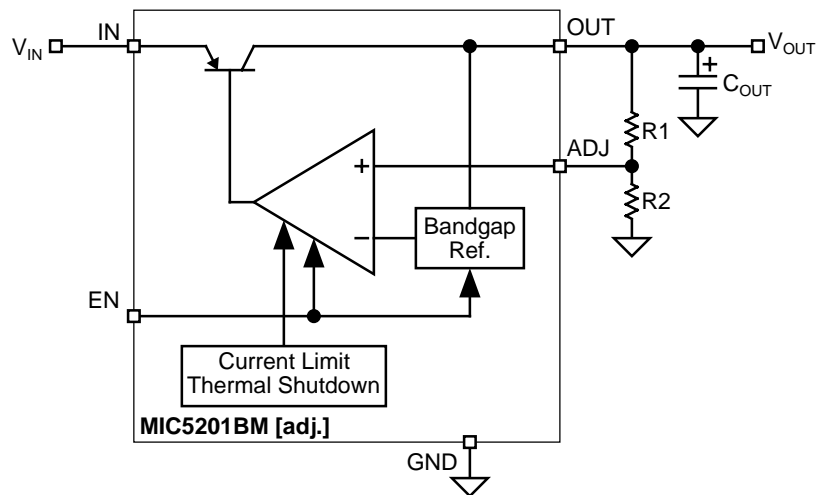

**Adjustable Regulator**

# Typical Characteristics

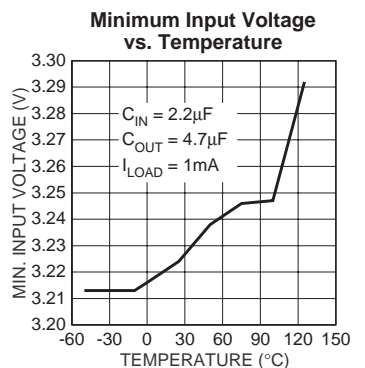
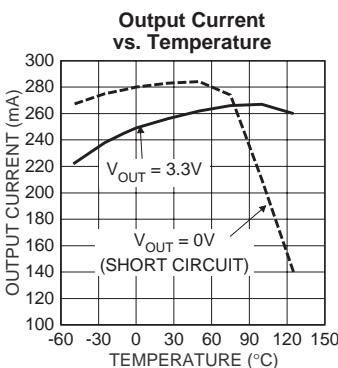
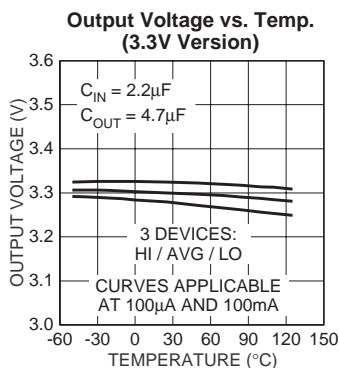
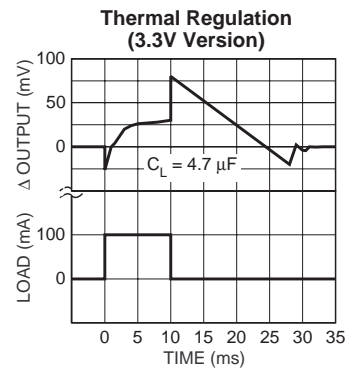
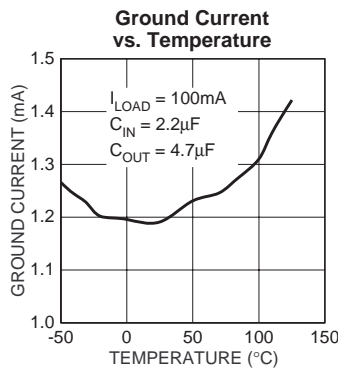
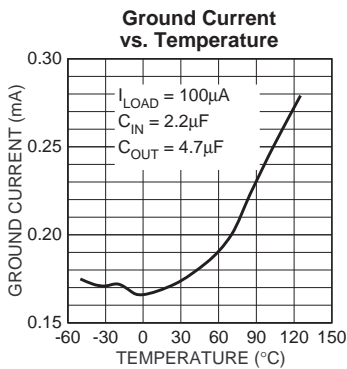
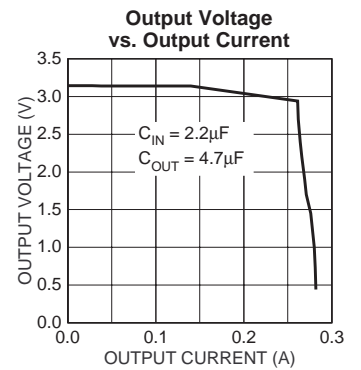
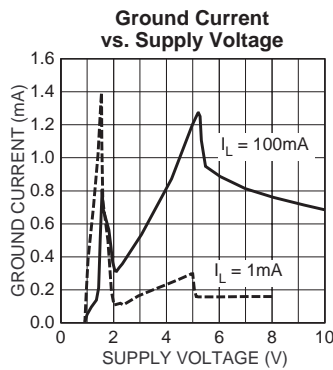
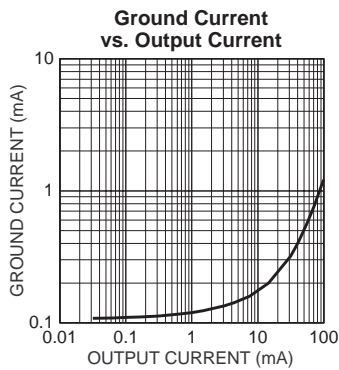
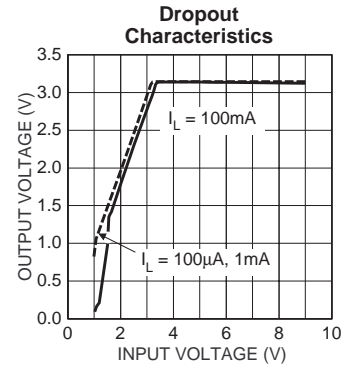
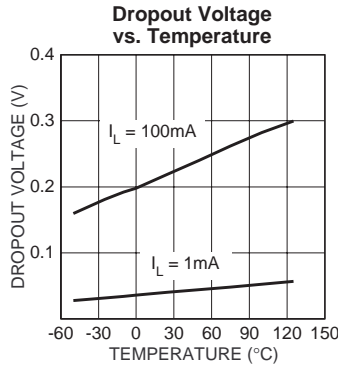
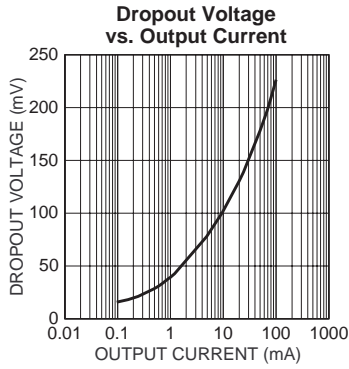

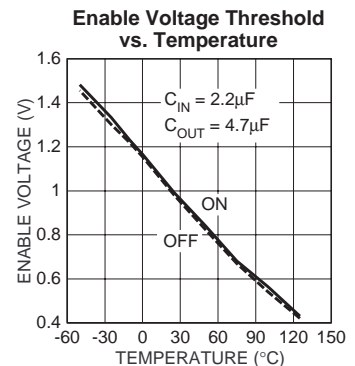
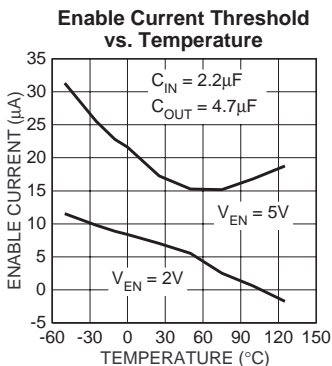
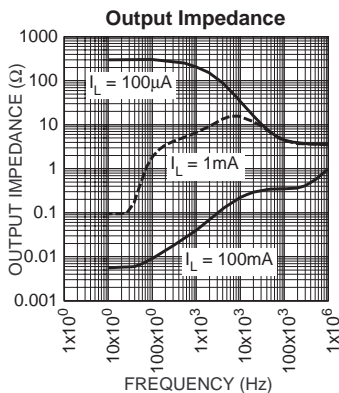
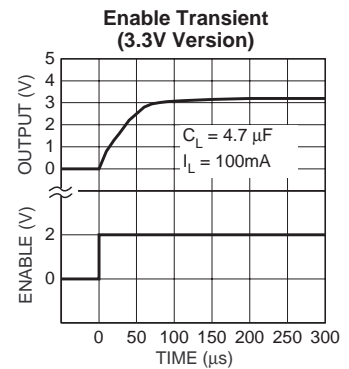
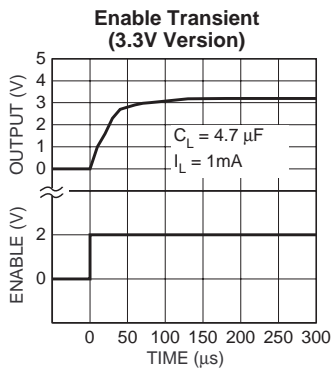
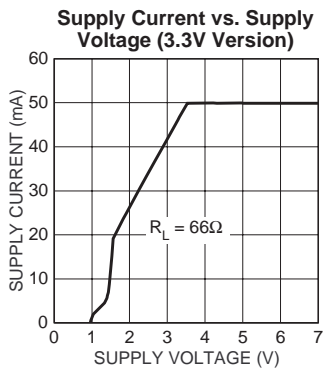
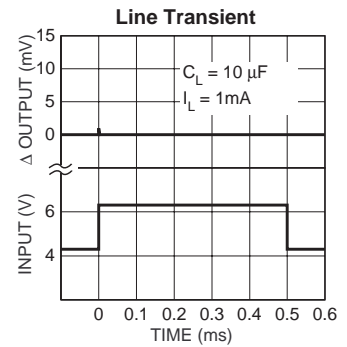
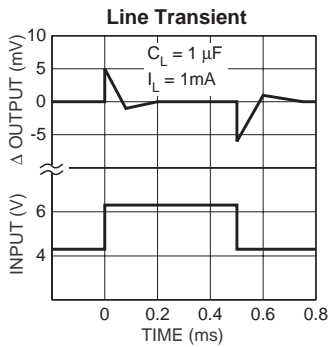
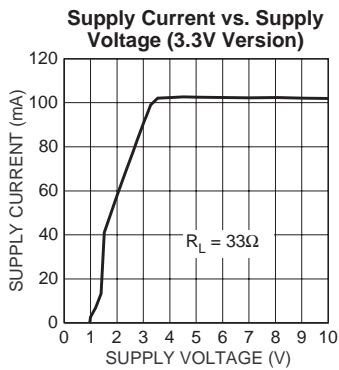
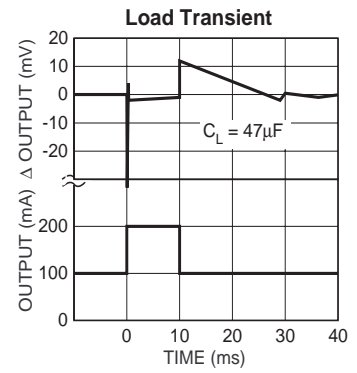
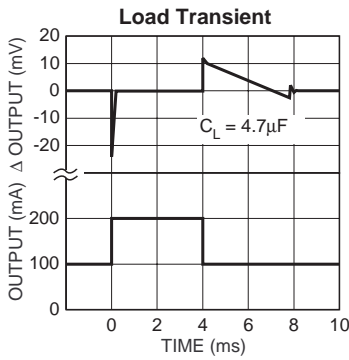
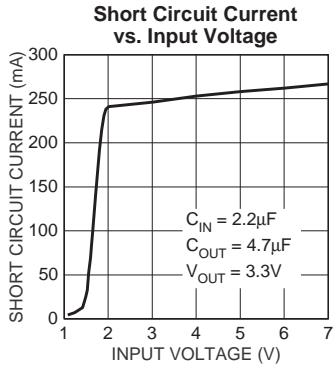

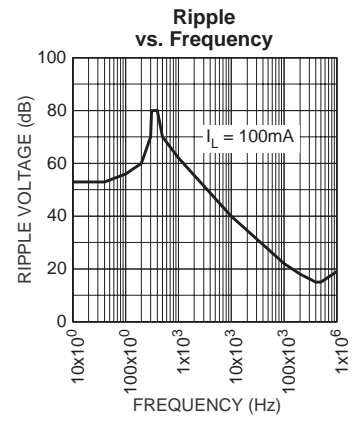
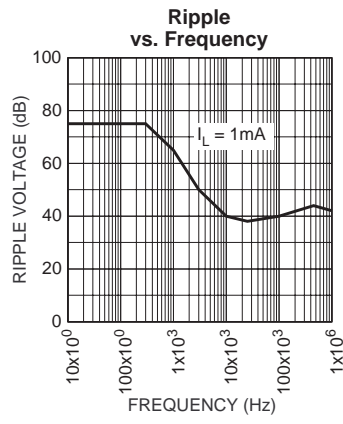
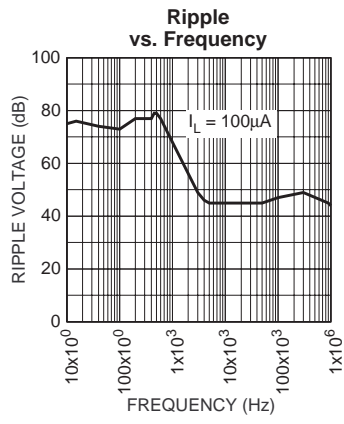

## Applications Information

Figure 1 shows a basic fixed-voltage application with the unused enable input connected to  $V_{IN}$ .

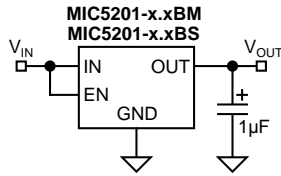

**Figure 1. Fixed Application**

Adjustable regulators require two resistors to set the output voltage. See Figure 2.

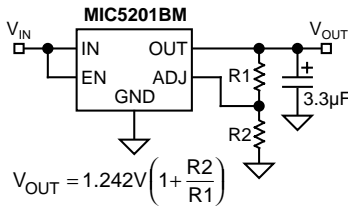

**Figure 2. Adjustable Application**

Resistors values are not critical because ADJ (adjust) has a high impedance, but for best results use resistors of 470kΩ or less.

### Output Capacitors

A 1µF capacitor is recommended between the MIC5201 output and ground to prevent oscillations due to instability. Larger values serve to improve the regulator's transient response. Most types of tantalum or aluminum electrolytics will be adequate; film types will work, but are costly and therefore not recommended. Many aluminum electrolytics have electrolytes that freeze at about  $-30^{\circ}\text{C}$ , so solid tantalums are recommended for operation below  $-25^{\circ}\text{C}$ . The important parameters of the capacitor are an effective series resistance of about 5Ω or less and a resonant frequency above 500kHz. The value of this capacitor may be increased without limit.

At lower values of output current, less output capacitance is required for output stability. The capacitor can be reduced to 0.47µF for current below 10mA or 0.33µF for currents below 1mA.

### Input Capacitors

A 1µF capacitor should be placed from the MIC5201 input to ground if there is more than 10 inches of wire between the input and the ac filter capacitor or if a battery is used as the input.

### Noise Reduction Capacitors

On adjustable devices, a capacitor from ADJ to GND will decrease high-frequency noise on the output. See Figure 3.

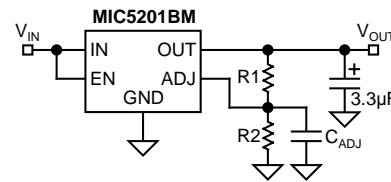

**Figure 3. Decreasing Output Noise**

### Minimum Load

The MIC5201 will remain stable and in regulation with no load unlike many other voltage regulators. This is especially important in CMOS RAM keep-alive applications.

### Dual-Supply Systems

When used in dual supply systems where the regulator load is returned to a negative supply, the output voltage must be diode clamped to ground. Thermal Considerations

### Layout

The MIC5201-x.xBM (8-pin surface mount package) has the following thermal characteristics when mounted on a single layer copper-clad printed circuit board.

PC Board Dielectric	$\theta_{JA}$
FR4	160° C/W
Ceramic	120° C/W

Multilayer boards having a ground plane, wide traces near the pads, and large supply bus lines provide better thermal conductivity.

The "worst case" value of 160°C/W assumes no ground plane, minimum trace widths, and a FR4 material board.

### Nominal Power Dissipation and Die Temperature

The MIC5201-x.xBM at a 25°C ambient temperature will operate reliably at up to 625mW power dissipation when mounted in the "worst case" manner described above. At an ambient temperature of 55°C, the device may safely dissipate 440mW. These power levels are equivalent to a die temperature of 125°C, the recommended maximum temperature for non-military grade silicon integrated circuits.

For MIC5201-x.xBS (SOT-223 package) heat sink characteristics, please refer to Micrel Application Hint 17, *P.C. Board Heat Sinking*.

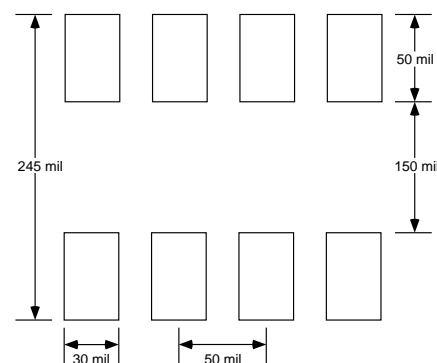

**Figure 4. Min. Recommended SO-8 PCB Pads Size**



Package Information

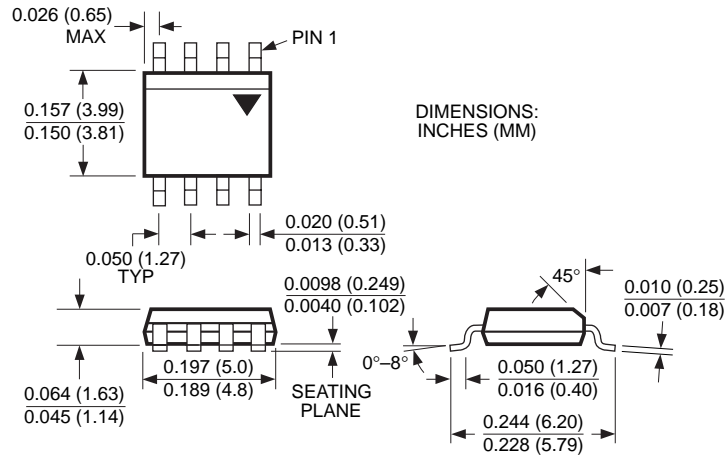

8-Pin SOIC (M)

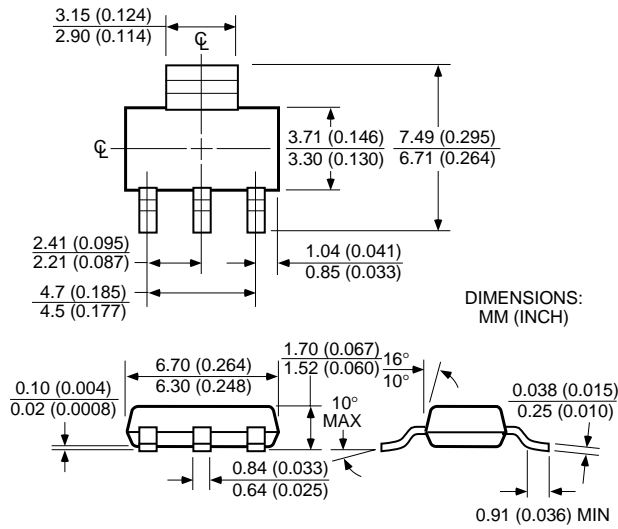

SOT-223 (S)





---

**MICREL INC. 1849 FORTUNE DRIVE SAN JOSE, CA 95131 USA**

TEL + 1 (408) 944-0800 FAX + 1 (408) 944-0970 WEB <http://www.micrel.com>

This information is believed to be accurate and reliable, however no responsibility is assumed by Micrel for its use nor for any infringement of patents or other rights of third parties resulting from its use. No license is granted by implication or otherwise under any patent or patent right of Micrel Inc.

© 1998 Micrel Incorporated