

100 mA Low-Dropout Regulator

Features

- High Output Voltage Accuracy
- Variety of Output Voltages
- Guaranteed 100 mA Output
- Low Quiescent Current
- Low Dropout Voltage
- Extremely Tight Load and Line Regulation
- Very Low Temperature Coefficient
- Current and Thermal Limiting
- Zero OFF Mode Current
- Logic-Controlled Electronic Shutdown
- Available in 8-Lead SOIC, MM8 8-Lead MSOP, and SOT-223 Packages

Applications

- Cellular Telephones
- Laptop, Notebook, and Palmtop Computers
- Battery-Powered Equipment
- PCMCIA V_{CC} and V_{PP} Regulation/Switching
- Barcode Scanners
- SMPS Post-Regulator/DC-to-DC Modules
- High Efficiency Linear Power Supplies

General Description

The MIC5200 is an efficient linear voltage regulator with very low dropout voltage (typically 17 mV at light loads and 200 mV at 100 mA), and very low ground current (1 mA at 100 mA output), offering better than 1% initial accuracy with a logic-compatible ON/OFF switching input. Designed especially for hand-held battery-powered devices, the MIC5200 is switched by a CMOS- or TTL-compatible logic signal. The ENABLE control may be tied directly to V_{IN} if unneeded. When disabled, power consumption drops nearly to zero. The ground current of the MIC5200 increases only slightly in dropout, further prolonging battery life. Key MIC5200 features include protection against reversed battery, current limiting, and overtemperature shutdown.

The MIC5200 is available in several fixed voltages and accuracy configurations. Other options are available; contact Microchip for details.

Typical Application Schematic

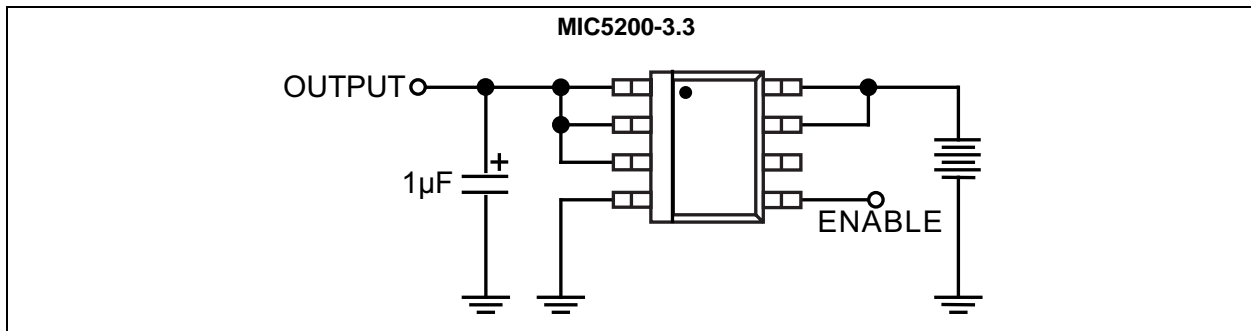

MIC5200

1.0 ELECTRICAL CHARACTERISTICS

Absolute Maximum Ratings †

Input Supply Voltage	-20V to +60V
Enable Input Voltage	-20V to +60V
Power Dissipation.....	Internally Limited

Operating Ratings ‡

Input Voltage	+2.5V to +26V
Enable Input Voltage	-20V to V_{IN}

† **Notice:** Stresses above those listed under “Absolute Maximum Ratings” may cause permanent damage to the device. This is a stress rating only and functional operation of the device at those or any other conditions above those indicated in the operational sections of this specification is not intended. Exposure to maximum rating conditions for extended periods may affect device reliability.

‡ **Notice:** The device is not guaranteed to function outside its operating ratings.

TABLE 1-1: ELECTRICAL CHARACTERISTICS

Electrical Characteristics: Limits in standard typeface are for $T_J = 25^\circ\text{C}$ and limits in **boldface** apply over the junction temperature range of -40°C to $+125^\circ\text{C}$. Unless otherwise specified, $V_{IN} = V_{OUT} + 1\text{V}$, $I_L = 1\text{ mA}$, $C_L = 3.3\text{ }\mu\text{F}$, and $V_{ENABLE} = V_{DD}$. (**Note 1**).

Parameters	Sym.	Min.	Typ.	Max.	Units	Conditions
Output Voltage Accuracy	V_O	-1	—	1	%	Variation from specified V_{OUT}
		-2	—	2		
Output Voltage Temperature Coefficient	$\Delta V_O/\Delta T$	—	40	150	ppm/ $^\circ\text{C}$	Note 2
Line Regulation	$\Delta V_O/V_{IN}$	—	0.004	0.10	%	$V_{IN} = V_{OUT} + 1\text{V}$ to 26V
		—	—	0.40		
Load Regulation	$\Delta V_O/V_{OUT}$	—	0.04	0.16	%	$I_L = 0.1\text{ mA}$ to 100 mA (Note 3)
		—	—	0.30		
Dropout Voltage (Note 4)	$V_{IN} - V_O$	—	17	—	mV	$I_L = 100\text{ }\mu\text{A}$
		—	130	—		$I_L = 20\text{ mA}$
		—	150	—		$I_L = 30\text{ mA}$
		—	190	—		$I_L = 50\text{ mA}$
		—	230	350		$I_L = 100\text{ mA}$
Quiescent Current	I_{GND}	—	0.01	10	μA	$V_{ENABLE} \leq 0.7\text{V}$ (shutdown)
Ground Pin Current	I_{GND}	—	130	—	μA	$V_{ENABLE} = V_{DD}$, $I_L = 100\text{ }\mu\text{A}$
		—	270	350		$I_L = 20\text{ mA}$
		—	330	—		$I_L = 30\text{ mA}$
		—	500	—		$I_L = 50\text{ mA}$
		—	1000	1500		$I_L = 100\text{ mA}$
Ripple Rejection	PSRR	—	70	—	dB	—
Ground Pin Current at Dropout	$I_{GND\text{DDO}}$	—	270	330	μA	$V_{IN} = 0.5\text{V}$ less than specified V_{OUT} , $I_L = 100\text{ }\mu\text{A}$ (Note 5)
Current Limit	I_{LIMIT}	100	250	—	mA	$V_{OUT} = 0\text{V}$
Thermal Regulation	$\Delta V_O/\Delta P_D$	—	0.05	—	%/W	Note 6
Output Noise	e_n	—	100	—	μV	—

Note 1: Specification for packaged product only.

2: Output voltage temperature coefficient is defined as the worst case voltage change divided by the total temperature range.

3: Regulation is measured at constant junction temperature using low duty cycle pulse testing. Parts are tested for load regulation in the load range from 0.1 mA to 100 mA. Changes in output voltage due to heating effects are covered by the thermal regulation specification.

4: Dropout voltage is defined as the input to output differential at which the output voltage drops 2% below its nominal value measured at 1V differential.

5: Ground pin current is the regulator quiescent current plus pass transistor base current. The total current drawn from the supply is the sum of the load current plus the ground pin current.

6: Thermal regulation is defined as the change in output voltage at a time (t) after a change in power dissipation is applied, excluding load or line regulation effects. Specifications are for a 100 mA load pulse at $V_{IN} = 26\text{V}$ for $t = 10\text{ ms}$.

MIC5200

TABLE 1-1: ELECTRICAL CHARACTERISTICS (CONTINUED)

Electrical Characteristics: Limits in standard typeface are for $T_J = 25^\circ\text{C}$ and limits in **boldface** apply over the junction temperature range of -40°C to $+125^\circ\text{C}$. Unless otherwise specified, $V_{IN} = V_{OUT} + 1\text{V}$, $I_L = 1\text{ mA}$, $C_L = 3.3\ \mu\text{F}$, and $V_{ENABLE} = V_{DD}$. (**Note 1**).

Parameters	Sym.	Min.	Typ.	Max.	Units	Conditions
ENABLE Input						
Input Voltage Level, Logic Low	V_{IL}	—	—	0.7	V	OFF
Input Voltage Level, Logic High	V_{IH}	2.0	—	—		ON
Enable Input Current	I_{IL}	—	0.01	1	μA	$V_{IL} \leq 0.7\text{V}$
	I_{IH}	—	15	50		$V_{IH} \geq 2.0\text{V}$

- Note 1:** Specification for packaged product only.
- Output voltage temperature coefficient is defined as the worst case voltage change divided by the total temperature range.
 - Regulation is measured at constant junction temperature using low duty cycle pulse testing. Parts are tested for load regulation in the load range from 0.1 mA to 100 mA. Changes in output voltage due to heating effects are covered by the thermal regulation specification.
 - Dropout voltage is defined as the input to output differential at which the output voltage drops 2% below its nominal value measured at 1V differential.
 - Ground pin current is the regulator quiescent current plus pass transistor base current. The total current drawn from the supply is the sum of the load current plus the ground pin current.
 - Thermal regulation is defined as the change in output voltage at a time (t) after a change in power dissipation is applied, excluding load or line regulation effects. Specifications are for a 100 mA load pulse at $V_{IN} = 26\text{V}$ for $t = 10\text{ ms}$.

TEMPERATURE SPECIFICATIONS

Parameters	Sym.	Min.	Typ.	Max.	Units	Conditions
Temperature Ranges						
Junction Operating Temperature Range	T_J	-40	—	+125	°C	Note 1
Lead Temperature	—	—	—	+260	°C	Soldering, 5s
Package Thermal Resistances						
Thermal Resistance, SOT-223	θ_{JC}	—	15	—	°C/W	—
Thermal Resistance, SOIC-8	θ_{JA}	—	160	—	°C/W	Note 2

- Note 1:** The maximum allowable power dissipation is a function of ambient temperature, the maximum allowable junction temperature and the thermal resistance from junction to air (i.e., T_A , T_J , θ_{JA}). Exceeding the maximum allowable power dissipation will cause the device operating junction temperature to exceed the maximum +125°C rating. Sustained junction temperatures above +125°C can impact the device reliability.
- 2:** The maximum allowable power dissipation at any ambient temperature is calculated using: $P_{(MAX)} = (T_{J(MAX)} - T_A) \div \theta_{JA}$. Exceeding the maximum allowable power dissipation will result in excessive die temperature, and the regulator will go into thermal shutdown. The θ_{JC} of the MIC5200-x.xYS is 15°C/W and θ_{JA} for the MIC5200YM is 160°C/W mounted on a PC board (see [Thermal Considerations](#) for further details).

MIC5200

2.0 TYPICAL PERFORMANCE CURVES

Note: The graphs and tables provided following this note are a statistical summary based on a limited number of samples and are provided for informational purposes only. The performance characteristics listed herein are not tested or guaranteed. In some graphs or tables, the data presented may be outside the specified operating range (e.g., outside specified power supply range) and therefore outside the warranted range.

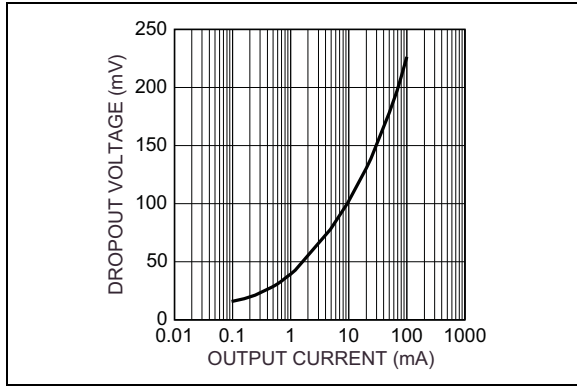

FIGURE 2-1: Dropout Voltage vs. Output Current.

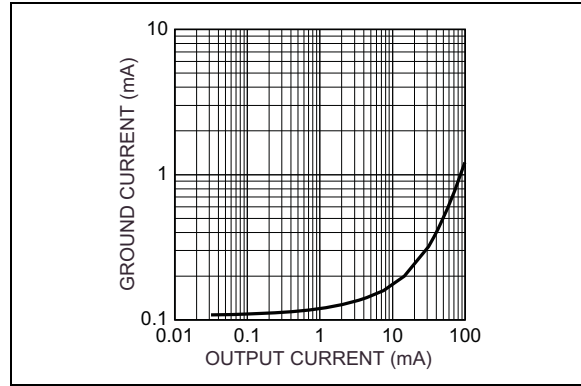

FIGURE 2-4: Ground Current vs. Output Current.

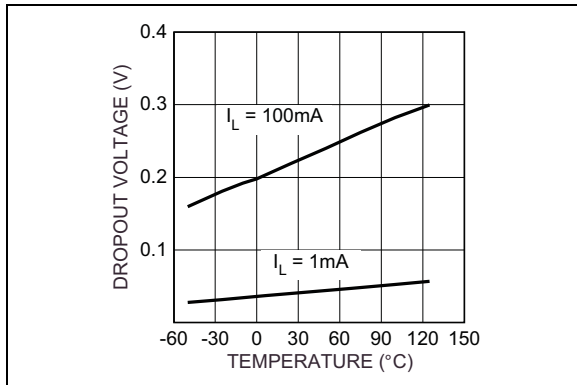

FIGURE 2-2: Dropout Voltage vs. Temperature.

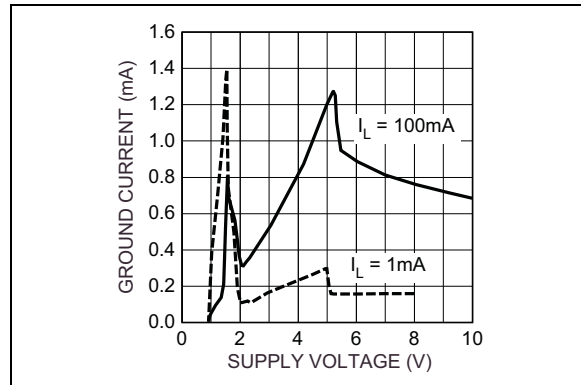

FIGURE 2-5: Ground Current vs. Supply Voltage.

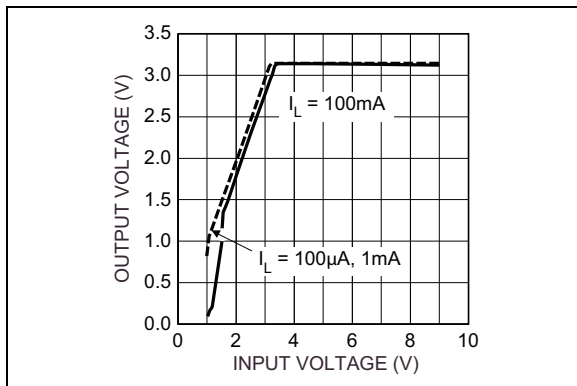

FIGURE 2-3: Dropout Characteristics.

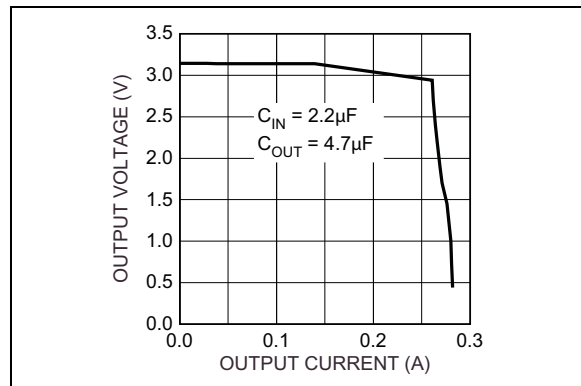

FIGURE 2-6: Output Voltage vs. Output Current.

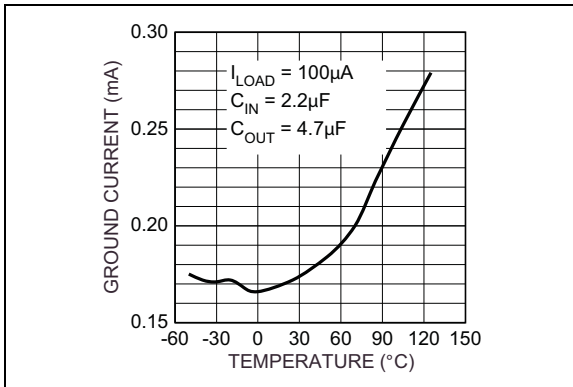

FIGURE 2-7: Ground Current vs. Temperature.

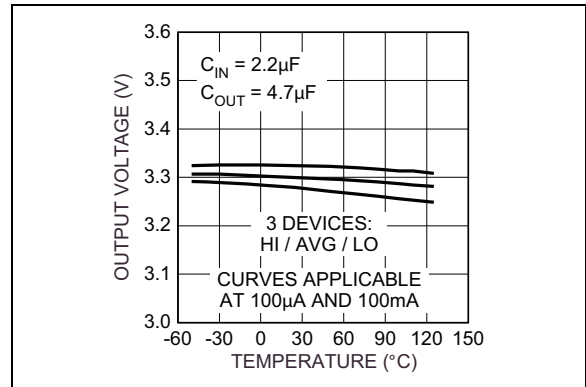

FIGURE 2-10: Output Voltage vs. Temperature (3.3V Version).

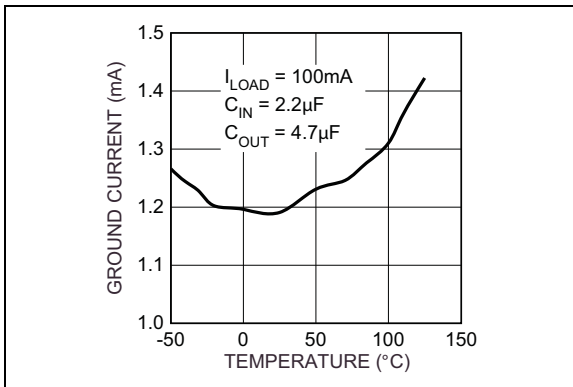

FIGURE 2-8: Ground Current vs. Temperature.

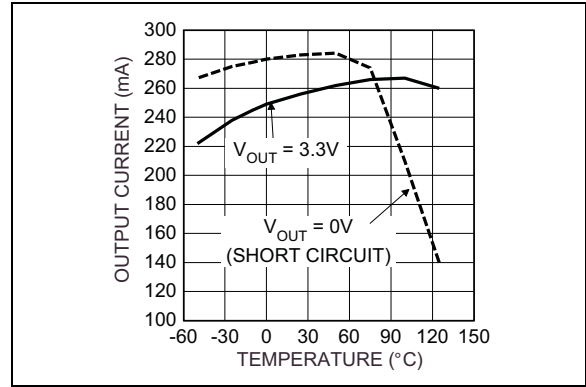

FIGURE 2-11: Output Current vs. Temperature.

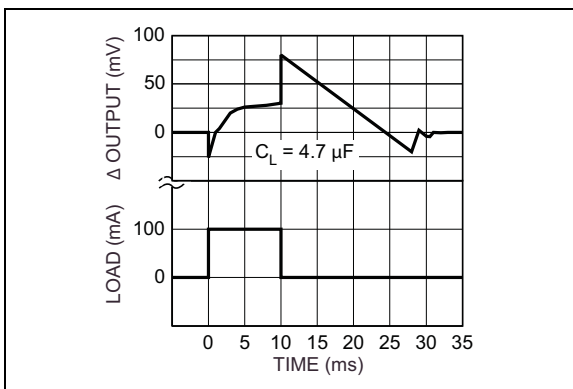

FIGURE 2-9: Thermal Regulation (3.3V Version).

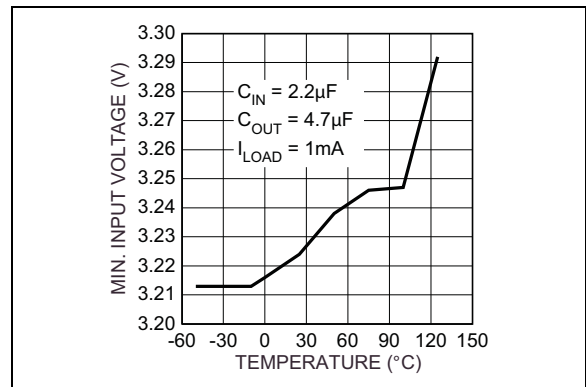

FIGURE 2-12: Minimum Input Voltage vs. Temperature.

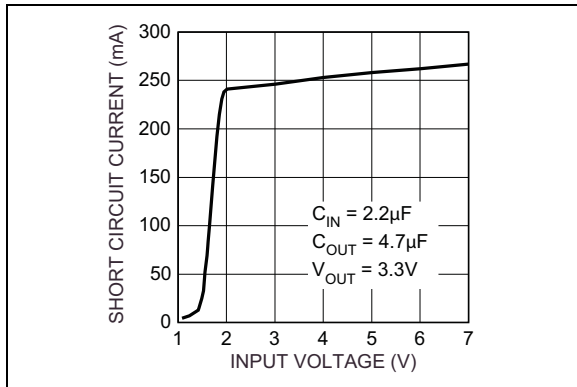

FIGURE 2-13: Short Circuit Current vs. Input Voltage.

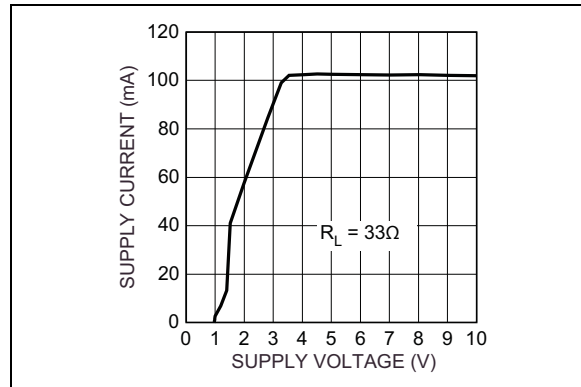

FIGURE 2-16: Supply Current vs. Supply Voltage (3.3V Version).

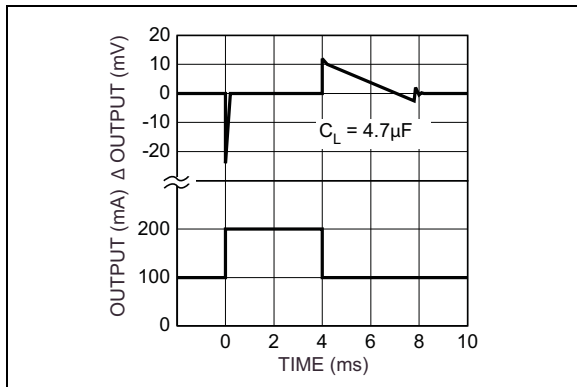

FIGURE 2-14: Load Transient.

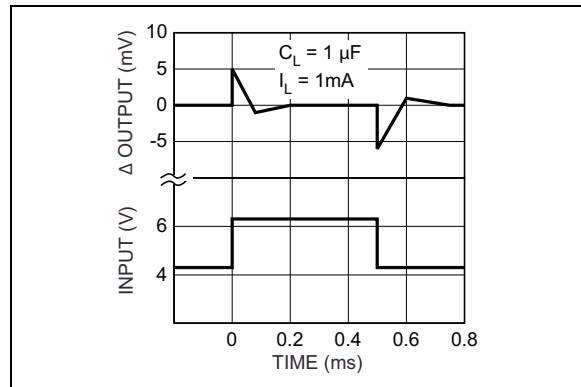

FIGURE 2-17: Line Transient.

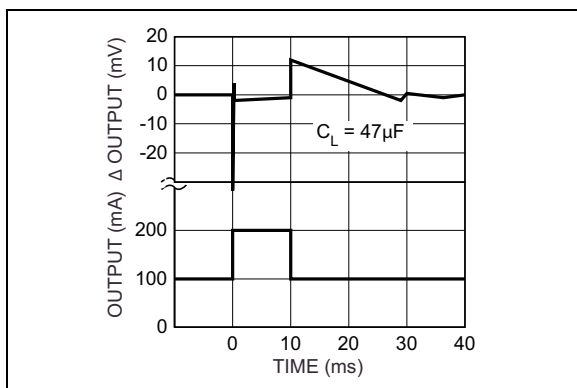

FIGURE 2-15: Load Transient.

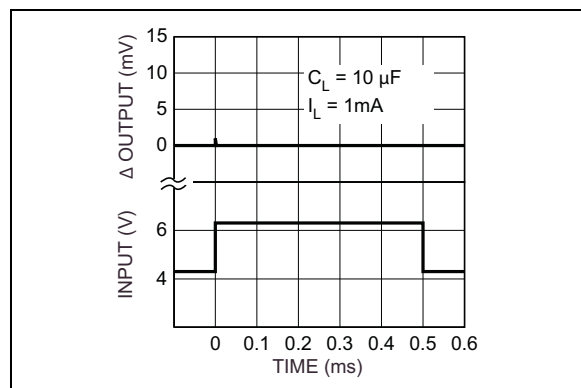

FIGURE 2-18: Line Transient.

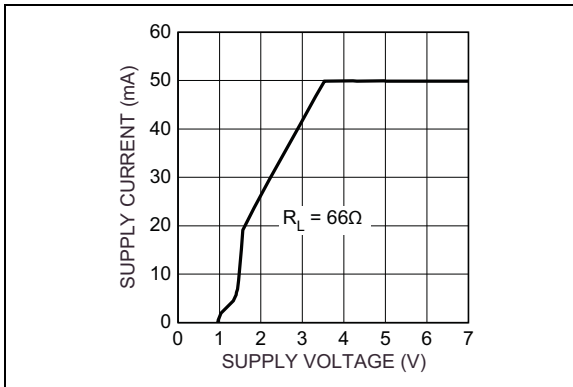

FIGURE 2-19: Supply Current vs. Supply Voltage (3.3V Version).

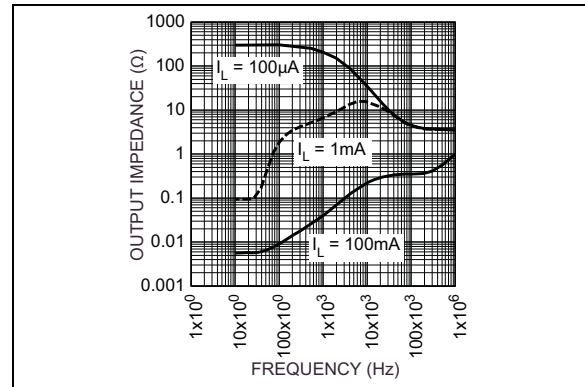

FIGURE 2-22: Output Impedance.

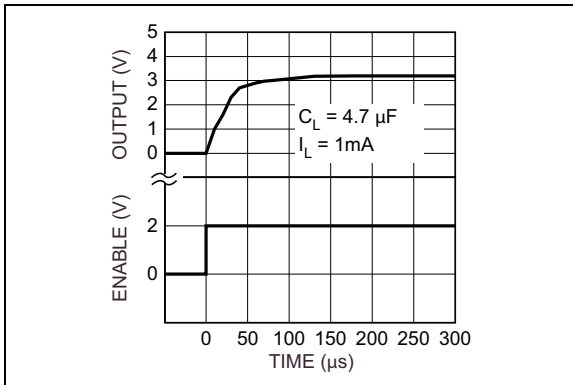

FIGURE 2-20: Enable Transient (3.3V Version).

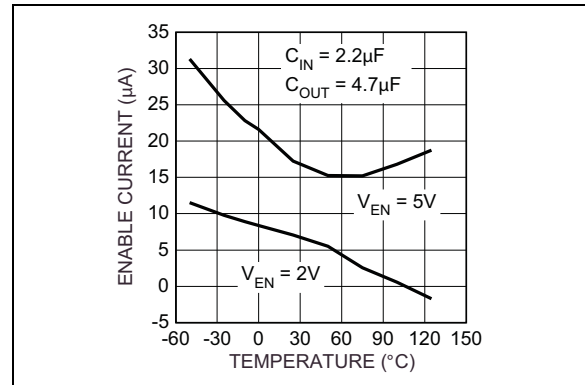

FIGURE 2-23: Enable Current Threshold vs. Temperature.

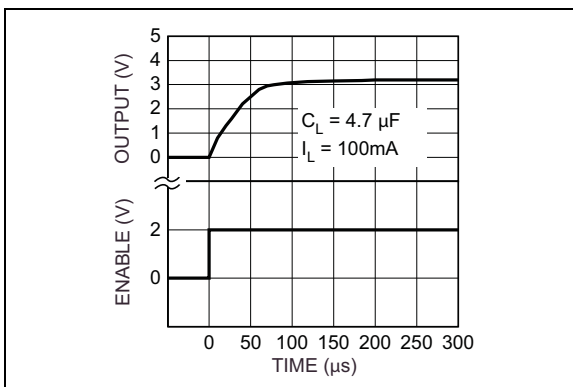

FIGURE 2-21: Enable Transient (3.3V Version).

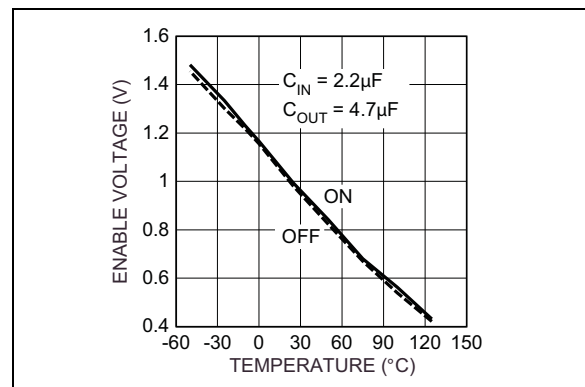

FIGURE 2-24: Enable Voltage Threshold vs. Temperature.

MIC5200

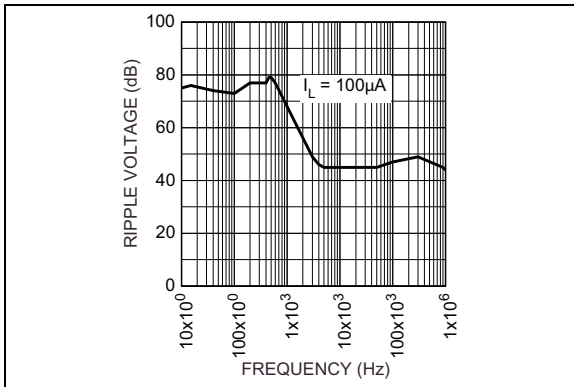

FIGURE 2-25: *Ripple vs. Frequency.*

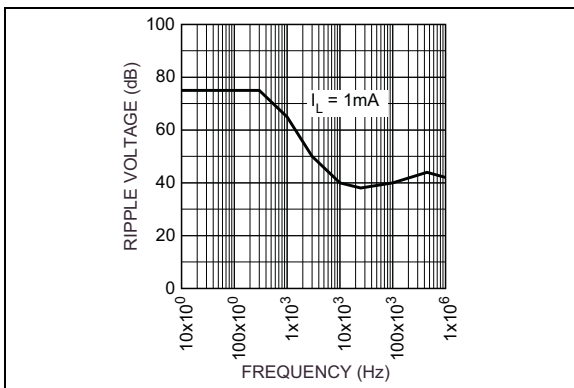

FIGURE 2-26: *Ripple vs. Frequency.*

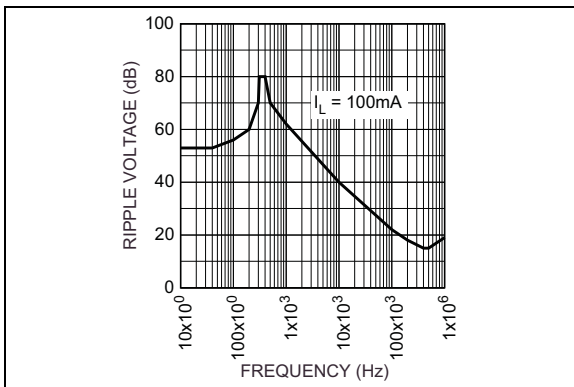

FIGURE 2-27: *Ripple vs. Frequency.*

3.0 PIN DESCRIPTIONS

The descriptions of the pins are listed in [Table 3-1](#).

Package Types

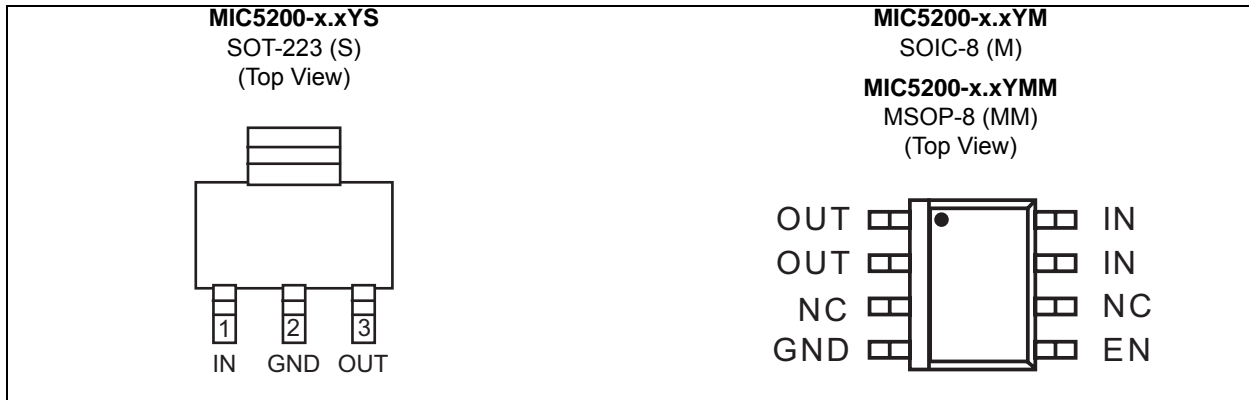

TABLE 3-1: PIN FUNCTION TABLE

Pin Number SOT-223	Pin Number SOIC-8, MSOP-8	Pin Name	Description
3	1, 2	OUT	Output: Pins 1 and 2 (SOIC-8, MSOP-8 packages) must be externally connected together.
—	3, 6	NC	Not internally connected. Connect to ground plane for lowest thermal resistance.
2, TAB	4	GND	Ground: Ground pin and TAB (SOT-223 package) are internally connected.
—	5	EN	Enable/Shutdown (Input): TTL-compatible. High = enabled; low = shutdown.
1	7, 8	IN	Supply Input: Pins 7 and 8 (SOIC-8, MSOP-8 packages) must be externally connected together.

MIC5200

4.0 APPLICATION INFORMATION

4.1 External Capacitors

A 1 μF capacitor is recommended between the MIC5200 output and ground to prevent oscillations due to instability. Larger values serve to improve the regulator's transient response. Most types of tantalum or aluminum electrolytics will be adequate; film types will work, but are costly and therefore not recommended. Many aluminum electrolytics have electrolytes that freeze at about -30°C , so solid tantalum capacitors are recommended for operation below -25°C . The important parameters of the capacitor are an effective series resistance of about 5Ω or less and a resonant frequency above 500 kHz. The value of this capacitor may be increased without limit.

At lower values of output current, less output capacitance is required for output stability. The capacitor can be reduced to 0.47 μF for current below 10 mA or 0.33 μF for currents below 1 mA. A 1 μF capacitor should be placed from the MIC5200 input to ground if there is more than 10 inches of wire between the input and the AC filter capacitor or if a battery is used as the input.

The MIC5200 will remain stable and in regulation with no load in addition to the internal voltage divider, unlike many other voltage regulators. This is especially important in CMOS RAM keep-alive applications.

When used in dual supply systems where the regulator load is returned to a negative supply, the output voltage must be diode clamped to ground.

4.2 ENABLE Input

The MIC5200 features nearly zero OFF mode current. When the ENABLE input is held below 0.7V, all internal circuitry is powered off. Pulling this pin high (over 2.0V) re-enables the device and allows operation. The ENABLE pin requires a small amount of current, typically 15 μA . While the logic threshold is TTL/CMOS compatible, ENABLE may be pulled as high as 30V, independent of the voltage on V_{IN} .

5.0 THERMAL CONSIDERATIONS

5.1 Layout

The MIC5200-x.xYM (8-pin surface mount package) has the following thermal characteristics when mounted on a single-layer copper-clad printed circuit board.

PC Board Dielectric	θ_{JA}
FR4	160 °C/W
Ceramic	120 °C/W

Multi-layer boards having a ground plane, wide traces near the pads, and large supply bus lines provide better thermal conductivity.

The "worst case" value of 160 °C/W assumes no ground plane, minimum trace widths, and a FR4 material board.

5.2 Nominal Power Dissipation and Die Temperature

The MIC5200-x.xYM at a 25°C ambient temperature will operate reliably at up to 625 mW power dissipation when mounted in the "worst case" manner described above. At an ambient temperature of 55°C, the device may safely dissipate 440 mW. These power levels are equivalent to a die temperature of 125°C, the recommended maximum temperature for non-military grade silicon integrated circuits.

For MIC5200-x.xYS (SOT-223 package) heat sink characteristics, please refer to Application Hint 17, "Calculating P.C. Board Heat Sink Area for Surface Mount Packages".

MIC5200

6.0 PACKAGING INFORMATION

6.1 Package Marking Information

8-Pin SOIC*



Example

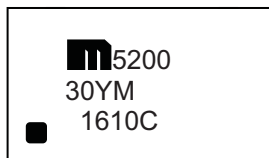

SOT-223*



Example



8-Pin MSOP*

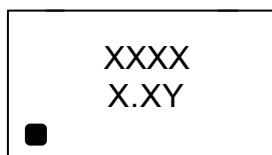

Example

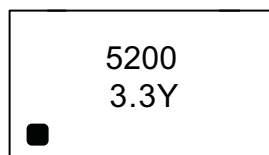

Legend:	XX...X	Product code or customer-specific information
	Y	Year code (last digit of calendar year)
	YY	Year code (last 2 digits of calendar year)
	WW	Week code (week of January 1 is week '01')
	NNN	Alphanumeric traceability code
	(e3)	Pb-free JEDEC® designator for Matte Tin (Sn)
	*	This package is Pb-free. The Pb-free JEDEC designator ((e3)) can be found on the outer packaging for this package.
	•, ▲, ▼	Pin one index is identified by a dot, delta up, or delta down (triangle mark).
Note:	In the event the full Microchip part number cannot be marked on one line, it will be carried over to the next line, thus limiting the number of available characters for customer-specific information. Package may or may not include the corporate logo.	
	Underbar () symbol may not be to scale.	

SOT-223 Package Outline and Recommended Land Pattern

Note: For the most current package drawings, please see the Microchip Packaging Specification located at <http://www.microchip.com/packaging>

TITLE

3 LEAD SOT223 PACKAGE OUTLINE & RECOMMENDED LAND PATTERN

DRAWING # SOT223-3LD-PL-1

UNIT MM

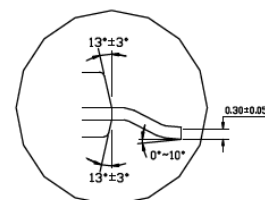
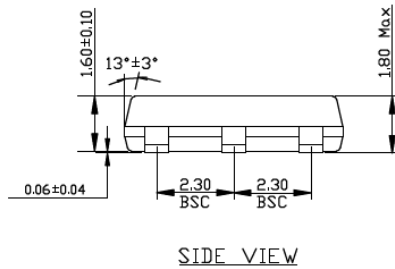
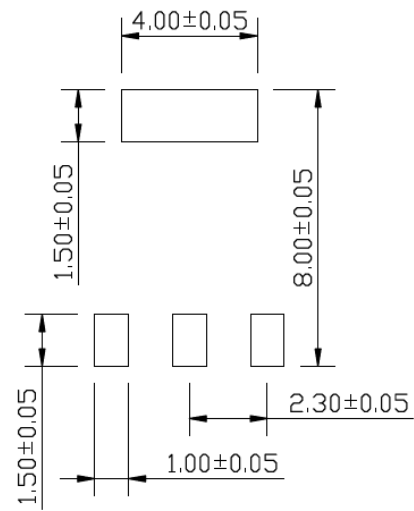
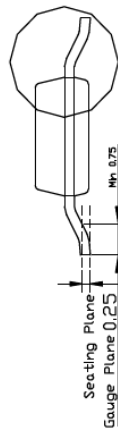
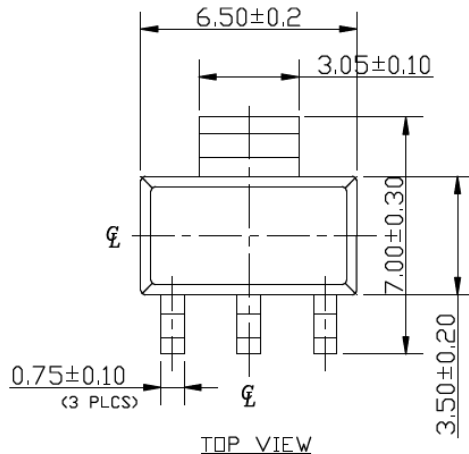

NOTE:

1. Dimensions and tolerances are as per ANSI Y14.5M, 1982.
2. Controlling dimension: Millimeters.
3. Dimensions are exclusive of mold flash and gate burr.
4. All specification comply to Jedec spec T0261 Issue C.

MIC5200

8-Lead MSOP Package Outline and Recommended Land Pattern

Note: For the most current package drawings, please see the Microchip Packaging Specification located at <http://www.microchip.com/packaging>

TITLE

8 LEAD MSOP PACKAGE OUTLINE & RECOMMENDED LAND PATTERN

DRAWING #	MSOP-8LD-PL-1	UNIT	INCH [MM]
-----------	---------------	------	-----------

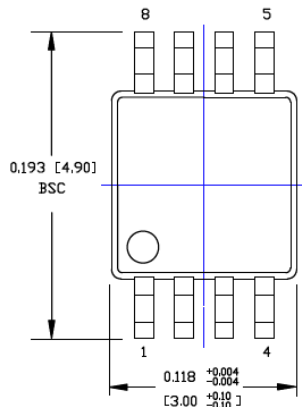

TOP VIEW

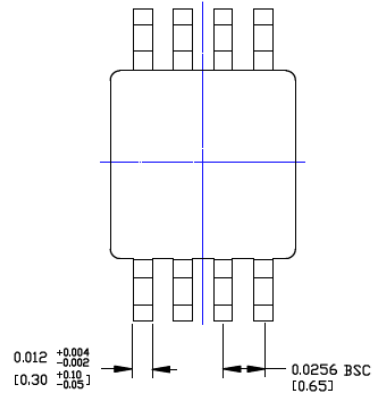

BOTTOM VIEW

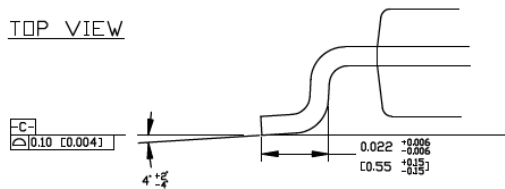

DETAIL A

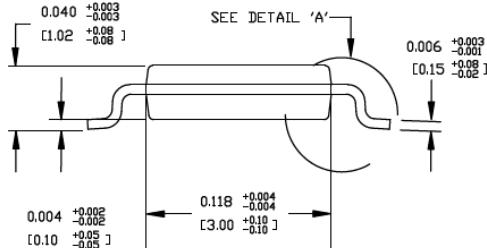

SIDE VIEW

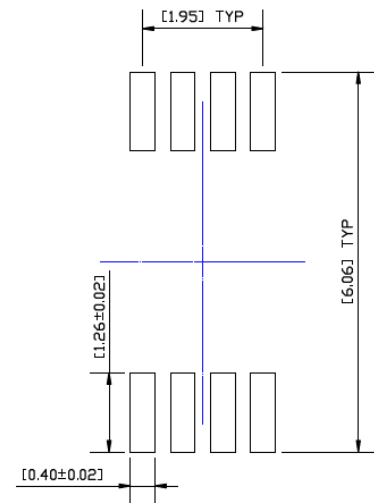

RECOMMENDED LAND PATTERN

NOTES:

1. DIMENSIONS ARE IN INCHES [MM].
2. CONTROLLING DIMENSION: MM
3. DIMENSION DOES NOT INCLUDE MOLD FLASH OR PROTRUSIONS, EITHER OF WHICH SHALL NOT EXCEED 0.008 [0.20] PER SIDE.

8-Lead SOIC-N Package Outline and Recommended Land Pattern

Note: For the most current package drawings, please see the Microchip Packaging Specification located at <http://www.microchip.com/packaging>

TITLE

8 LEAD SOICN PACKAGE OUTLINE & RECOMMENDED LAND PATTERN

DRAWING # SOICN-8LD-PL-1

UNIT INCH [MM]

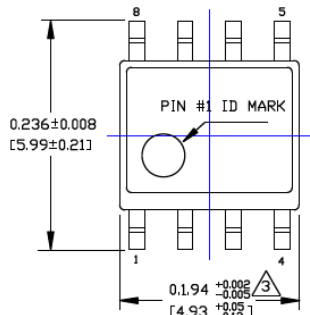

TOP VIEW

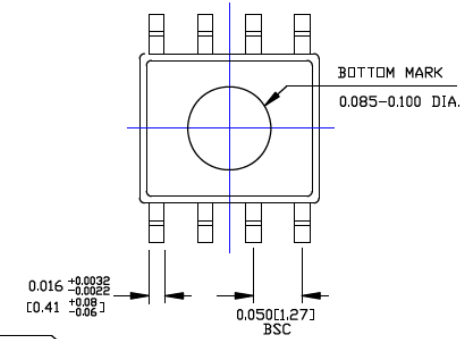

BOTTOM VIEW

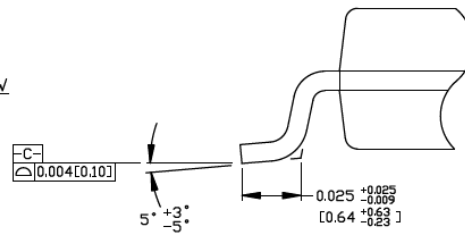

DETAIL "A"

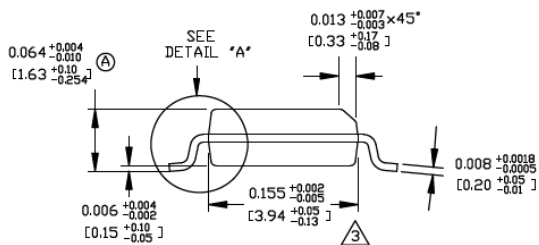

END VIEW

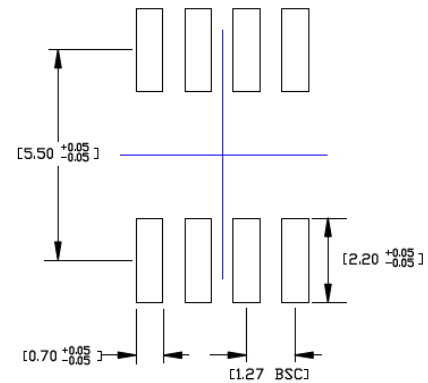

RECOMMENDED LAND PATTERN

NOTES:

1. DIMENSIONS ARE IN INCHES[MM].
2. CONTROLLING DIMENSION: INCHES.
3. DIMENSION DOES NOT INCLUDE MOLD FLASH OR PROTRUSIONS, EITHER OF WHICH SHALL NOT EXCEED 0.010[0.25] PER SIDE.

APPENDIX A: REVISION HISTORY

Revision A (July 2016)

- Converted Micrel document MIC5200 to Microchip data sheet DS20005578A.
- Minor text changes throughout.

MIC5200

NOTES:

PRODUCT IDENTIFICATION SYSTEM

To order or obtain information, e.g., on pricing or delivery, contact your local Microchip representative or sales office.

<u>PART NO.</u>	-	<u>XX</u>	<u>X</u>	<u>XX</u>	-	<u>XX</u>
Device		Voltage	Temperature	Package		Media Type
Device:		MIC5200:		100 mA Low-Dropout Regulator		
Voltage: (Note 1)		3.0 = 3.0V 3.3 = 3.3V 4.8 = 4.8V 5.0 = 5.0V				
Temperature:		Y = -40°C to +125°C				
Package:		M = 8-Pin SOIC MM = 8-Pin MSOP S = SOT-223				
Media Type:		TR = 2,500/Reel blank = 95/Tube				
Note 1:	The 8-Pin MSOP package (MM) is only available in 3.3V and 5.0V options.					
Examples:						
a)	MIC5200-3.0YM:	100 mA Low-Dropout Regulator, 3.0V Voltage, -40°C to +125°C Temp. Range, 8-Pin SOIC, 95/Tube				
b)	MIC5200-4.8YM-TR:	100 mA Low-Dropout Regulator, 4.85 Voltage, -40°C to +125°C Temp. Range, 8-Pin SOIC, 2,500/Reel				
c)	MIC5200-3.3YMM:	100 mA Low-Dropout Regulator, 3.3V Voltage, -40°C to +125°C Temp. Range, 8-Pin MSOP, 95/Tube				
d)	MIC5200-5.0YMM-TR:	100 mA Low-Dropout Regulator, 5.0V Voltage, -40°C to +125°C Temp. Range, 8-Pin MSOP, 2,500/Reel				
e)	MIC5200-3.3YS:	100 mA Low-Dropout Regulator, 3.3V Voltage, -40°C to +125°C Temp. Range, SOT-223, 95/Tube				
f)	MIC5200-5.0YS-TR	100 mA Low-Dropout Regulator, 5.0V Voltage, -40°C to +125°C Temp. Range, SOT-223, 2,500/Reel				

MIC5200

NOTES:

Note the following details of the code protection feature on Microchip devices:

- Microchip products meet the specification contained in their particular Microchip Data Sheet.
- Microchip believes that its family of products is one of the most secure families of its kind on the market today, when used in the intended manner and under normal conditions.
- There are dishonest and possibly illegal methods used to breach the code protection feature. All of these methods, to our knowledge, require using the Microchip products in a manner outside the operating specifications contained in Microchip's Data Sheets. Most likely, the person doing so is engaged in theft of intellectual property.
- Microchip is willing to work with the customer who is concerned about the integrity of their code.
- Neither Microchip nor any other semiconductor manufacturer can guarantee the security of their code. Code protection does not mean that we are guaranteeing the product as “unbreakable.”

Code protection is constantly evolving. We at Microchip are committed to continuously improving the code protection features of our products. Attempts to break Microchip's code protection feature may be a violation of the Digital Millennium Copyright Act. If such acts allow unauthorized access to your software or other copyrighted work, you may have a right to sue for relief under that Act.

Information contained in this publication regarding device applications and the like is provided only for your convenience and may be superseded by updates. It is your responsibility to ensure that your application meets with your specifications. MICROCHIP MAKES NO REPRESENTATIONS OR WARRANTIES OF ANY KIND WHETHER EXPRESS OR IMPLIED, WRITTEN OR ORAL, STATUTORY OR OTHERWISE, RELATED TO THE INFORMATION, INCLUDING BUT NOT LIMITED TO ITS CONDITION, QUALITY, PERFORMANCE, MERCHANTABILITY OR FITNESS FOR PURPOSE. Microchip disclaims all liability arising from this information and its use. Use of Microchip devices in life support and/or safety applications is entirely at the buyer's risk, and the buyer agrees to defend, indemnify and hold harmless Microchip from any and all damages, claims, suits, or expenses resulting from such use. No licenses are conveyed, implicitly or otherwise, under any Microchip intellectual property rights unless otherwise stated.

Microchip received ISO/TS-16949:2009 certification for its worldwide headquarters, design and wafer fabrication facilities in Chandler and Tempe, Arizona; Gresham, Oregon and design centers in California and India. The Company's quality system processes and procedures are for its PIC® MCUs and dsPIC® DSCs, KEELoc® code hopping devices, Serial EEPROMs, microperipherals, nonvolatile memory and analog products. In addition, Microchip's quality system for the design and manufacture of development systems is ISO 9001:2000 certified.

**QUALITY MANAGEMENT SYSTEM
CERTIFIED BY DNV
= ISO/TS 16949 =**

Trademarks

The Microchip name and logo, the Microchip logo, AnyRate, dsPIC, FlashFlex, flexPWR, Heldo, JukeBlox, KeeLoq, KeeLoq logo, Klear, LANCheck, LINK MD, MediaLB, MOST, MOST logo, MPLAB, OptoLyzer, PIC, PICSTART, PIC32 logo, RightTouch, SpyNIC, SST, SST Logo, SuperFlash and UNI/O are registered trademarks of Microchip Technology Incorporated in the U.S.A. and other countries.

ClockWorks, The Embedded Control Solutions Company, ETHERSYNCH, Hyper Speed Control, HyperLight Load, IntelliMOS, mTouch, Precision Edge, and QUIET-WIRE are registered trademarks of Microchip Technology Incorporated in the U.S.A.

Analog-for-the-Digital Age, Any Capacitor, AnyIn, AnyOut, BodyCom, chipKIT, chipKIT logo, CodeGuard, dsPICDEM, dsPICDEM.net, Dynamic Average Matching, DAM, ECAN, EtherGREEN, In-Circuit Serial Programming, ICSP, Inter-Chip Connectivity, JitterBlocker, KlearNet, KlearNet logo, MiWi, motorBench, MPASM, MPF, MPLAB Certified logo, MPLIB, MPLINK, MultiTRAK, NetDetach, Omniscient Code Generation, PICDEM, PICDEM.net, PICkit, PICtail, PureSilicon, RightTouch logo, REAL ICE, Ripple Blocker, Serial Quad I/O, SQL, SuperSwitcher, SuperSwitcher II, Total Endurance, TSHARC, USBCheck, VariSense, ViewSpan, WiperLock, Wireless DNA, and ZENA are trademarks of Microchip Technology Incorporated in the U.S.A. and other countries.

SQTP is a service mark of Microchip Technology Incorporated in the U.S.A.

Silicon Storage Technology is a registered trademark of Microchip Technology Inc. in other countries.

GestIC is a registered trademarks of Microchip Technology Germany II GmbH & Co. KG, a subsidiary of Microchip Technology Inc., in other countries.

All other trademarks mentioned herein are property of their respective companies.

© 2016, Microchip Technology Incorporated, Printed in the U.S.A., All Rights Reserved.

ISBN: 978-1-5224-0785-0



MICROCHIP

Worldwide Sales and Service

AMERICAS

Corporate Office

2355 West Chandler Blvd.
Chandler, AZ 85224-6199

Tel: 480-792-7200

Fax: 480-792-7277

Technical Support:

[http://www.microchip.com/
support](http://www.microchip.com/support)

Web Address:

www.microchip.com

Atlanta

Duluth, GA

Tel: 678-957-9614

Fax: 678-957-1455

Austin, TX

Tel: 512-257-3370

Boston

Westborough, MA

Tel: 774-760-0087

Fax: 774-760-0088

Chicago

Itasca, IL

Tel: 630-285-0071

Fax: 630-285-0075

Cleveland

Independence, OH

Tel: 216-447-0464

Fax: 216-447-0643

Dallas

Addison, TX

Tel: 972-818-7423

Fax: 972-818-2924

Detroit

Novi, MI

Tel: 248-848-4000

Houston, TX

Tel: 281-894-5983

Indianapolis

Noblesville, IN

Tel: 317-773-8323

Fax: 317-773-5453

Los Angeles

Mission Viejo, CA

Tel: 949-462-9523

Fax: 949-462-9608

New York, NY

Tel: 631-435-6000

San Jose, CA

Tel: 408-735-9110

Canada - Toronto

Tel: 905-695-1980

Fax: 905-695-2078

ASIA/PACIFIC

Asia Pacific Office

Suites 3707-14, 37th Floor
Tower 6, The Gateway
Harbour City, Kowloon

Hong Kong

Tel: 852-2943-5100

Fax: 852-2401-3431

Australia - Sydney

Tel: 61-2-9868-6733

Fax: 61-2-9868-6755

China - Beijing

Tel: 86-10-8569-7000

Fax: 86-10-8528-2104

China - Chengdu

Tel: 86-28-8665-5511

Fax: 86-28-8665-7889

China - Chongqing

Tel: 86-23-8980-9588

Fax: 86-23-8980-9500

China - Dongguan

Tel: 86-769-8702-9880

China - Guangzhou

Tel: 86-20-8755-8029

China - Hangzhou

Tel: 86-571-8792-8115

Fax: 86-571-8792-8116

China - Hong Kong SAR

Tel: 852-2943-5100

Fax: 852-2401-3431

China - Nanjing

Tel: 86-25-8473-2460

Fax: 86-25-8473-2470

China - Qingdao

Tel: 86-532-8502-7355

Fax: 86-532-8502-7205

China - Shanghai

Tel: 86-21-5407-5533

Fax: 86-21-5407-5066

China - Shenyang

Tel: 86-24-2334-2829

Fax: 86-24-2334-2393

China - Shenzhen

Tel: 86-755-8864-2200

Fax: 86-755-8203-1760

China - Wuhan

Tel: 86-27-5980-5300

Fax: 86-27-5980-5118

China - Xian

Tel: 86-29-8833-7252

Fax: 86-29-8833-7256

ASIA/PACIFIC

China - Xiamen

Tel: 86-592-2388138

Fax: 86-592-2388130

China - Zhuhai

Tel: 86-756-3210040

Fax: 86-756-3210049

India - Bangalore

Tel: 91-80-3090-4444

Fax: 91-80-3090-4123

India - New Delhi

Tel: 91-11-4160-8631

Fax: 91-11-4160-8632

India - Pune

Tel: 91-20-3019-1500

Japan - Osaka

Tel: 81-6-6152-7160

Fax: 81-6-6152-9310

Japan - Tokyo

Tel: 81-3-6880-3770

Fax: 81-3-6880-3771

Korea - Daegu

Tel: 82-53-744-4301

Fax: 82-53-744-4302

Korea - Seoul

Tel: 82-2-554-7200

Fax: 82-2-558-5932 or

82-2-558-5934

Malaysia - Kuala Lumpur

Tel: 60-3-6201-9857

Fax: 60-3-6201-9859

Malaysia - Penang

Tel: 60-4-227-8870

Fax: 60-4-227-4068

Philippines - Manila

Tel: 63-2-634-9065

Fax: 63-2-634-9069

Singapore

Tel: 65-6334-8870

Fax: 65-6334-8850

Taiwan - Hsin Chu

Tel: 886-3-5778-366

Fax: 886-3-5770-955

Taiwan - Kaohsiung

Tel: 886-7-213-7828

Taiwan - Taipei

Tel: 886-2-2508-8600

Fax: 886-2-2508-0102

Thailand - Bangkok

Tel: 66-2-694-1351

Fax: 66-2-694-1350

EUROPE

Austria - Wels

Tel: 43-7242-2244-39

Fax: 43-7242-2244-393

Denmark - Copenhagen

Tel: 45-4450-2828

Fax: 45-4485-2829

France - Paris

Tel: 33-1-69-53-63-20

Fax: 33-1-69-30-90-79

Germany - Dusseldorf

Tel: 49-2129-3766400

Germany - Karlsruhe

Tel: 49-721-625370

Germany - Munich

Tel: 49-89-627-144-0

Fax: 49-89-627-144-44

Italy - Milan

Tel: 39-0331-742611

Fax: 39-0331-466781

Italy - Venice

Tel: 39-049-7625286

Netherlands - Drunen

Tel: 31-416-690399

Fax: 31-416-690340

Poland - Warsaw

Tel: 48-22-3325737

Spain - Madrid

Tel: 34-91-708-08-90

Fax: 34-91-708-08-91

Sweden - Stockholm

Tel: 46-8-5090-4654

UK - Wokingham

Tel: 44-118-921-5800

Fax: 44-118-921-5820

06/23/16