

### General Description

The MIC3775 is a 750mA low-dropout linear voltage regulators that provides low-voltage, high-current output from an extremely small package. Utilizing Micrel's proprietary Super $\beta$  PNP<sup>®</sup> pass element, the MIC3775 offers extremely low-dropout (typically 280mV at 750mA) and low ground current (typically 7.5mA at 750mA).

The MIC3775 is ideal for PC add-in cards that need to convert from standard 5V to 3.3V or 3.0V, 3.3V to 2.5V or 2.5V to 1.8V or 1.65V. A guaranteed maximum dropout voltage of 500mV over all operating conditions allows the MIC3775 to provide 2.5V from a supply as low as 3.0V and 1.8V or 1.5V from a supply as low as 2.25V.

The MIC3775 is fully protected with overcurrent limiting, thermal shutdown, and reversed-leakage protection. Fixed and adjustable output voltage options are available with an operating temperature range of  $-40^{\circ}\text{C}$  to  $+125^{\circ}\text{C}$ .

Data sheets and support documentation can be found on Micrel's web site at [www.micrel.com](http://www.micrel.com).

### Features

- Fixed and adjustable output voltages to 1.24V
- 280mV typical dropout at 750mA
  - **Ideal for 3.0V to 2.5V conversion**
  - **Ideal for 2.5V to 1.8V or 1.65V conversion**
- **Stable with ceramic capacitor**
- 750mA minimum guaranteed output current
- 1% initial accuracy
- Low ground current
- Current limiting and thermal shutdown
- Reversed-leakage protection
- Fast transient response
- Low-profile power MSOP-8 package

### Applications

- Fiber optic modules
- LDO linear regulator for PC add-in cards
- PowerPC<sup>™</sup> power supplies
- High-efficiency linear power supplies
- SMPS post regulator
- Multimedia and PC processor supplies
- Battery chargers
- Low-voltage microcontrollers and digital logic

### Typical Application

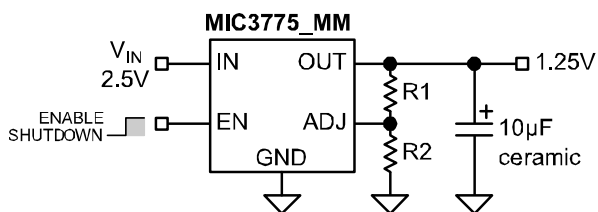

**1.25V/750mA Adjustable Regulator**

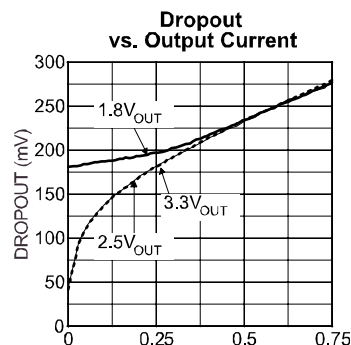

PowerPC is a trademark of IBM Corp.  
Super  $\beta$  PNP is a registered trademark of Micrel, Inc.

## Ordering Information

| Part Number     |                 | Voltage | Junction Temp. Range | Package    |
|-----------------|-----------------|---------|----------------------|------------|
| Standard        | Pb-Free         |         |                      |            |
| MIC3775-1.5BMM  | MIC3775-1.5YMM  | 1.5V    | -40° to +125°C       | 8-Pin MSOP |
| MIC3775-1.65BMM | MIC3775-1.65YMM | 1.65V   | -40° to +125°C       | 8-Pin MSOP |
| MIC3775-1.8BMM  | MIC3775-1.8YMM  | 1.8V    | -40° to +125°C       | 8-Pin MSOP |
| MIC3775-2.5BMM  | MIC3775-2.5YMM  | 2.5V    | -40° to +125°C       | 8-Pin MSOP |
| MIC3775-3.0BMM  | MIC3775-3.0YMM  | 3.0V    | -40° to +125°C       | 8-Pin MSOP |
| MIC3775-3.3BMM  | MIC3775-3.3YMM  | 3.3V    | -40° to +125°C       | 8-Pin MSOP |
| MIC3775BMM      | MIC3775YMM      | Adj.    | -40° to +125°C       | 8-Pin MSOP |

**Note:** For other voltages. Contact Micrel Marketing for details.

## Pin Configuration

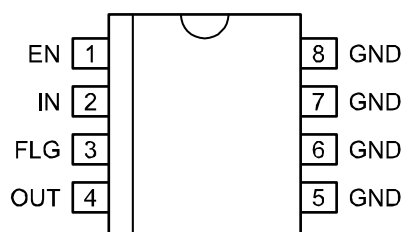

**MIC3775-x.x (Fixed)  
8-Pin MSOP (MM)**

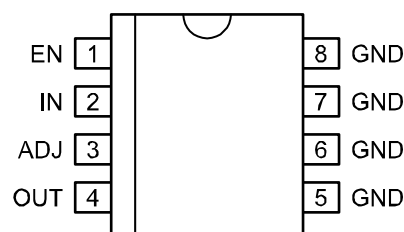

**MIC3775 (Adjustable)  
8-Pin MSOP (MM)**

## Pin Description

| Pin Number | Pin Name | Pin Function  |
|------------|----------|---|
| 1          | EN       | Enable (Input): CMOS-compatible control input. Logic high = enable, logic low or open = shutdown. |
| 2          | IN       | Supply (Input).   |
| 3          | FLG      | Flag (Output): Open-collector error flag output. Active low = output under-voltage.               |
|            | ADJ      | Adjustment Input: Feedback input. Connect to resistive voltage-divider network.                   |
| 4          | OUT      | Regulator Output.   |
| 5 – 8      | GND      | Ground.   |

**Absolute Maximum Ratings<sup>(1)</sup>**

|   |                 |
|---|-----------------|
| Supply Voltage ( $V_{IN}$ ).....          | 6.5V            |
| Enable Voltage ( $V_{EN}$ ).....          | 6.5V            |
| Lead Temperature (soldering, 5 sec.)..... | 260°C           |
| Storage Temperature ( $T_s$ ).....        | -65°C to +150°C |
| EDS Rating.....                           | <b>Note 3</b>   |

**Operating Ratings<sup>(2)</sup>**

|   |                 |
|---|-----------------|
| Supply Voltage ( $V_{IN}$ ).....                | +2.25V to +6V   |
| Enable Voltage ( $V_{EN}$ ).....                | 0V to +6V       |
| Maximum Power Dissipation ( $P_{D(MAX)}$ )..... | <b>Note 4</b>   |
| Junction Temperature ( $T_J$ ).....             | -40°C to +125°C |
| Package Thermal Resistance                      |                 |
| MSOP-8 ( $\theta_{JA}$ ).....                   | 80°C/W          |

**Electrical Characteristics<sup>(5)</sup>**

$V_{IN} = V_{OUT} + 1V$ ;  $V_{EN} = 2.25V$ ;  $T_J = 25^\circ C$ , **bold** values indicate  $-40^\circ C \leq T_J \leq +125^\circ C$ , unless noted.

| Symbol                        | Parameter                                       | Condition   | Min          | Typ   | Max          | Units   |
|-------------------------------|---|---|--------------|-------|--------------|---------|
| $V_{OUT}$                     | Output Voltage                                  | 10mA  | -1           |       | 1            | %       |
|                               |   | $10mA \leq I_{OUT} \leq 750mA$ , $V_{OUT} + 1V \leq V_{IN} \leq 6V$ | <b>-2</b>    |       | <b>2</b>     | %       |
|                               | Line Regulation                                 | $I_{OUT} = 10mA$ , $V_{OUT} + 1V \leq V_{IN} \leq 6V$               |              | 0.06  | 0.5          | %       |
|                               | Load Regulation                                 | $V_{IN} = V_{OUT} + 1V$ , $10mA \leq I_{OUT} \leq 750mA$            |              | 0.2   | 1            | %       |
| $\Delta V_{OUT}/\Delta T$     | Output Voltage Temp. Coefficient, <b>Note 6</b> |   |              | 40    |              | ppm/°C  |
| $V_{DO}$                      | Dropout Voltage, <b>Note 7</b>                  | $I_{OUT} = 100mA$ , $\Delta V_{OUT} = -1\%$                         |              | 125   | 200          | mV      |
|                               |   | $I_{OUT} = 500mA$ , $\Delta V_{OUT} = -1\%$                         |              | 210   | <b>250</b>   | mV      |
|                               |   | $I_{OUT} = 750mA$ , $\Delta V_{OUT} = -1\%$                         |              | 280   | <b>500</b>   | mV      |
| $I_{GND}$                     | Ground Current, <b>Note 8</b>                   | $I_{OUT} = 100mA$ , $V_{IN} = V_{OUT} + 1V$                         |              | 700   |              | $\mu A$ |
|                               |   | $I_{OUT} = 500mA$ , $V_{IN} = V_{OUT} + 1V$                         |              | 3.7   |              | mA      |
|                               |   | $I_{OUT} = 750mA$ , $V_{IN} = V_{OUT} + 1V$                         |              | 7.5   | <b>15</b>    | mA      |
| $I_{OUT(lim)}$                | Current Limit                                   | $V_{OUT} = 0V$ , $V_{IN} = V_{OUT} + 1V$                            |              | 1.6   | 2.5          | A       |
| <b>Enable Input</b>           |   |   |              |       |              |         |
| $V_{EN}$                      | Enable Input Voltage                            | logic low (off)   |              |       | <b>0.8</b>   | V       |
|                               |   | logic high (on)   | <b>2.25</b>  |       |              | V       |
| $I_{EN}$                      | Enable Input Current                            | $V_{EN} = 2.25V$  | 1            | 10    | <b>30</b>    | $\mu A$ |
|                               |   | $V_{EN} = 0.8V$   |              |       | 2            | $\mu A$ |
|                               |   |   |              |       | <b>4</b>     | $\mu A$ |
| <b>Flag Output</b>            |   |   |              |       |              |         |
| $I_{FLG(leak)}$               | Output Leakage Current                          | $V_{OH} = 6V$   |              | 0.01  | 1            | $\mu A$ |
|                               |   |   |              |       | <b>2</b>     | $\mu A$ |
| $V_{FLG(do)}$                 | Output Low Voltage                              | $V_{IN} = 2.250V$ , $I_{OL} = 250\mu A$                             |              | 250   | <b>500</b>   | mV      |
| $V_{FLG}$                     | Low Threshold                                   | % of $V_{OUT}$  | 93           |       |              | %       |
|                               | High Threshold                                  | % of $V_{OUT}$  |              |       | 99.2         | %       |
|                               | Hysteresis                                      |   |              | 1     |              | %       |
| <b>Adjustable Output Only</b> |   |   |              |       |              |         |
|                               | Reference Voltage                               |   | 1.227        | 1.240 | 1.252        | V       |
|                               |   |   | <b>1.215</b> |       | <b>1.265</b> | V       |
|                               | Adjust Pin Bias Current                         |   |              | 40    | 80           | nA      |
|                               |   |   |              |       | <b>120</b>   | nA      |

**Notes:**

1. Exceeding the absolute maximum rating may damage the device.
2. The device is not guaranteed to function outside its operating rating.
3. Devices are ESD sensitive. Handling precautions recommended.
4.  $P_{D(max)} = (T_{J(max)} - T_A) \div \theta_{JA}$ , where  $\theta_{JA}$  depends upon the printed circuit layout. See "Applications Information."
5. Specification for packaged product only.
6. Output voltage temperature coefficient is  $\Delta V_{OUT(worst\ case)} \div (T_{J(max)} - T_{J(min)})$  where  $T_{J(max)}$  is  $+125^{\circ}C$  and  $T_{J(min)}$  is  $-40^{\circ}C$ .
7.  $V_{DO} = V_{IN} - V_{OUT}$  when  $V_{OUT}$  decreases to 98% of its nominal output voltage with  $V_{IN} = V_{OUT} + 1V$ . For output voltages below 1.75V, dropout voltage is the input-to-output voltage differential with the minimum input voltage being 2.25V. Minimum input operating voltage is 2.25V.
8.  $I_{GND}$  is the quiescent current.  $I_{IN} = I_{GND} + I_{OUT}$ .

# Typical Characteristics

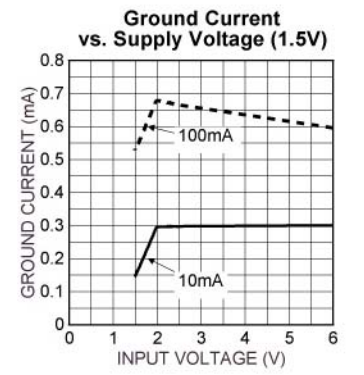
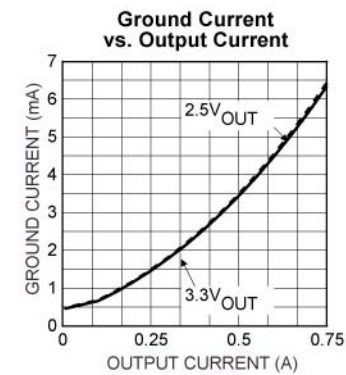
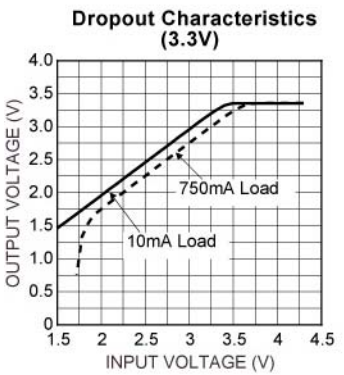
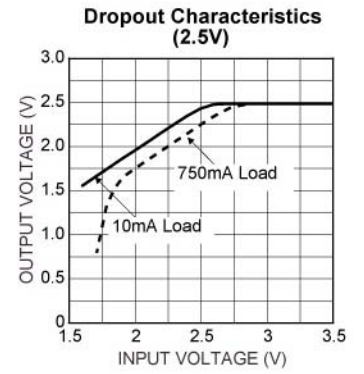
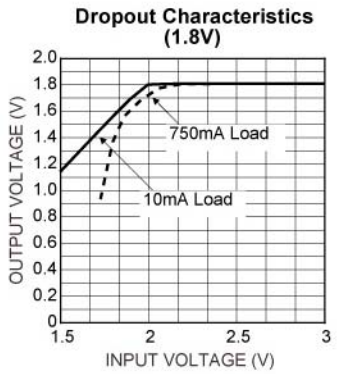
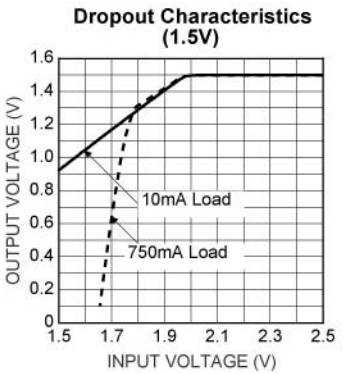
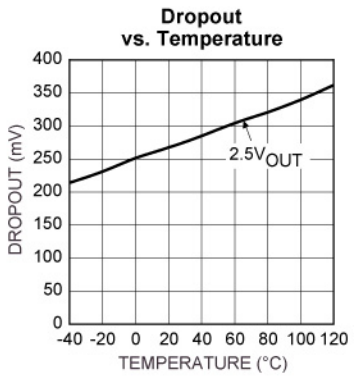
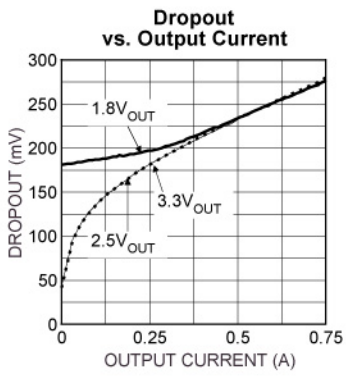
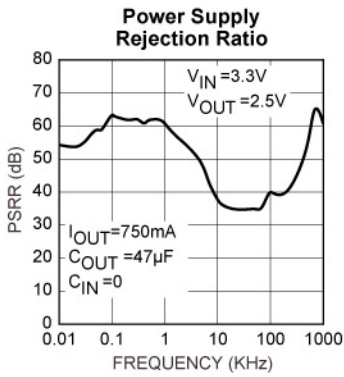
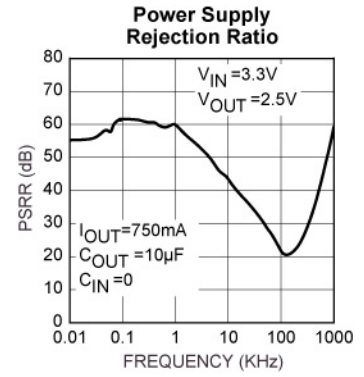
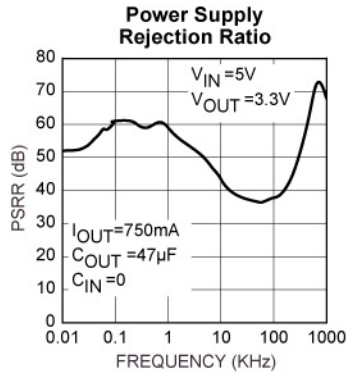
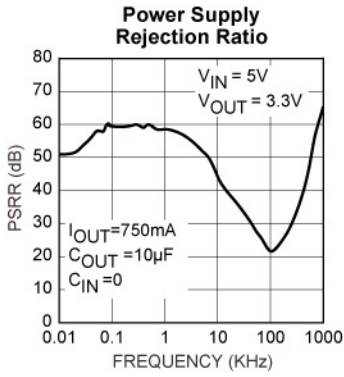

Typical Characteristics (cont.)

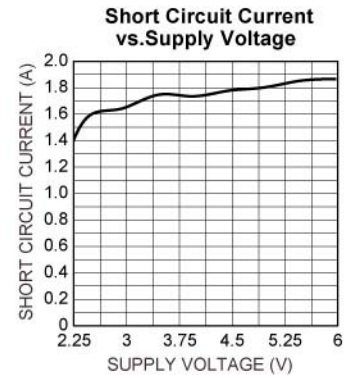
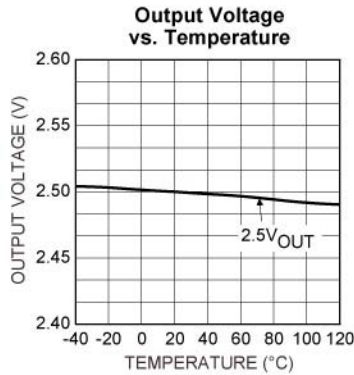
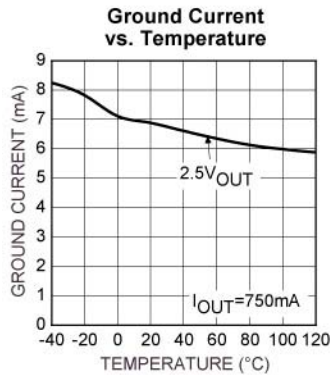
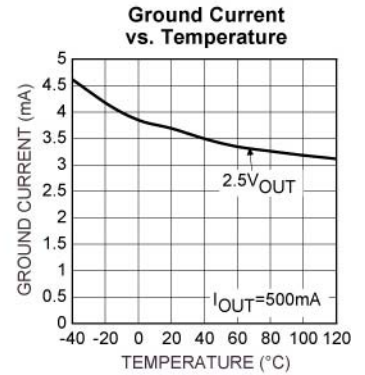
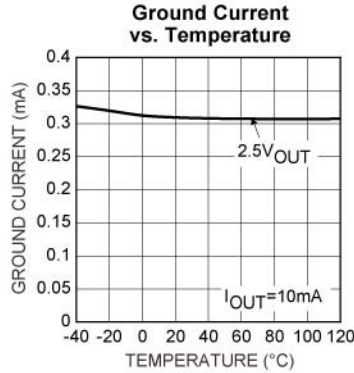
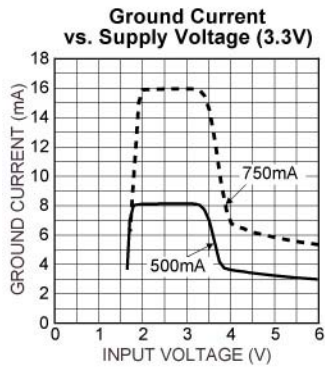
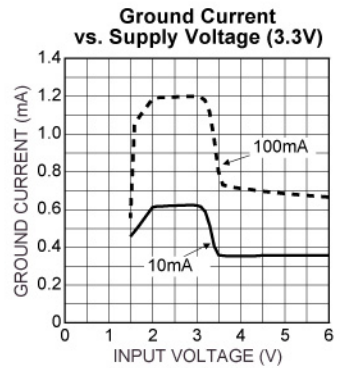
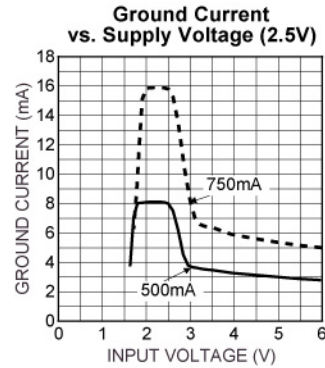
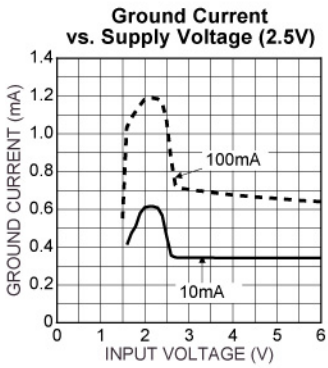
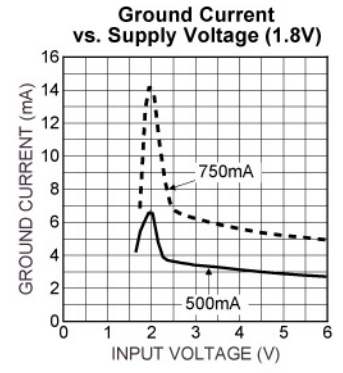
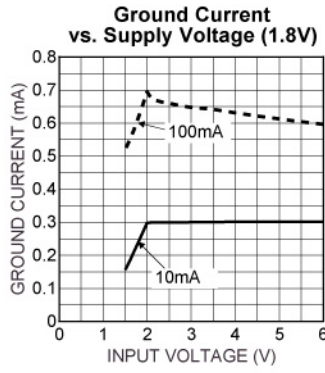
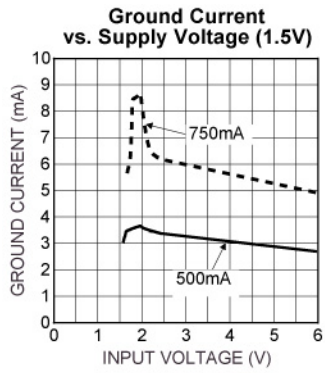

### Typical Characteristics (cont.)

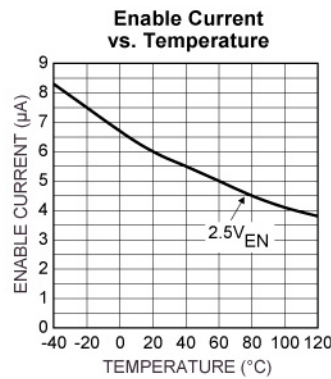
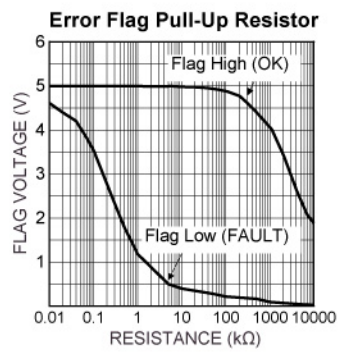
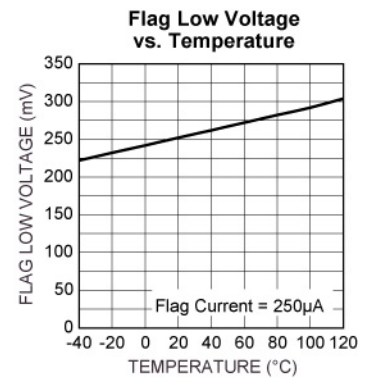
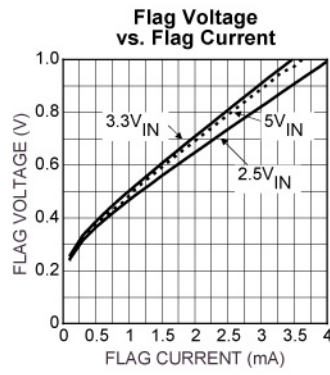
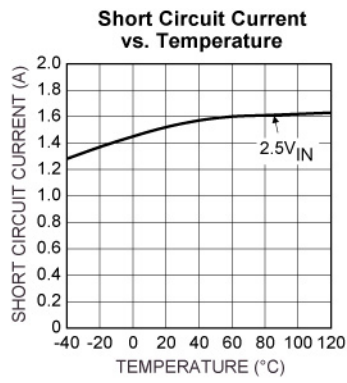

## Functional Characteristics

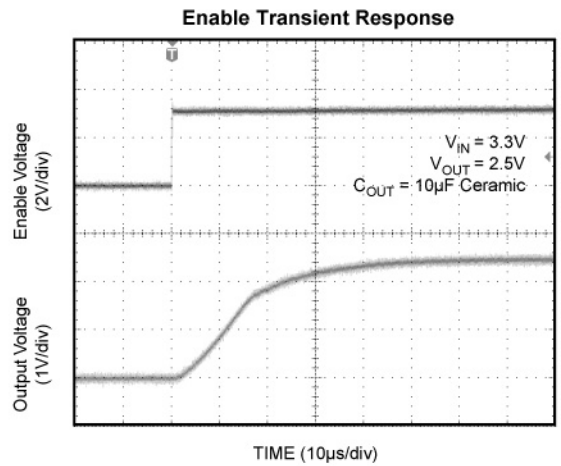
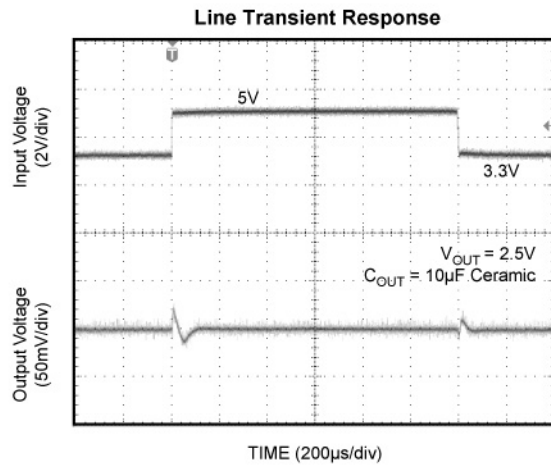
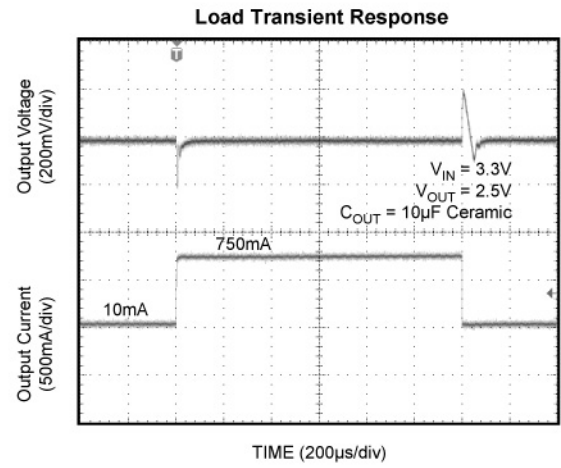
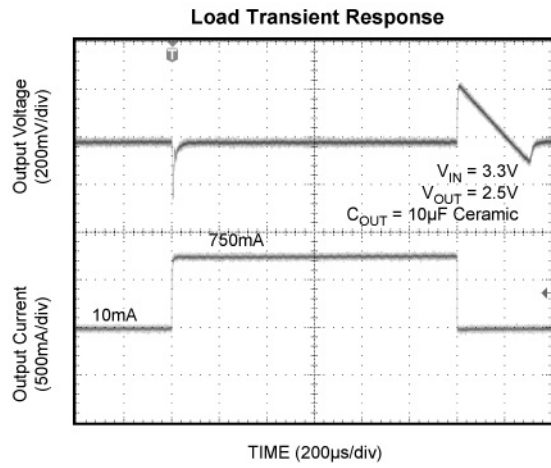



## Functional Diagrams

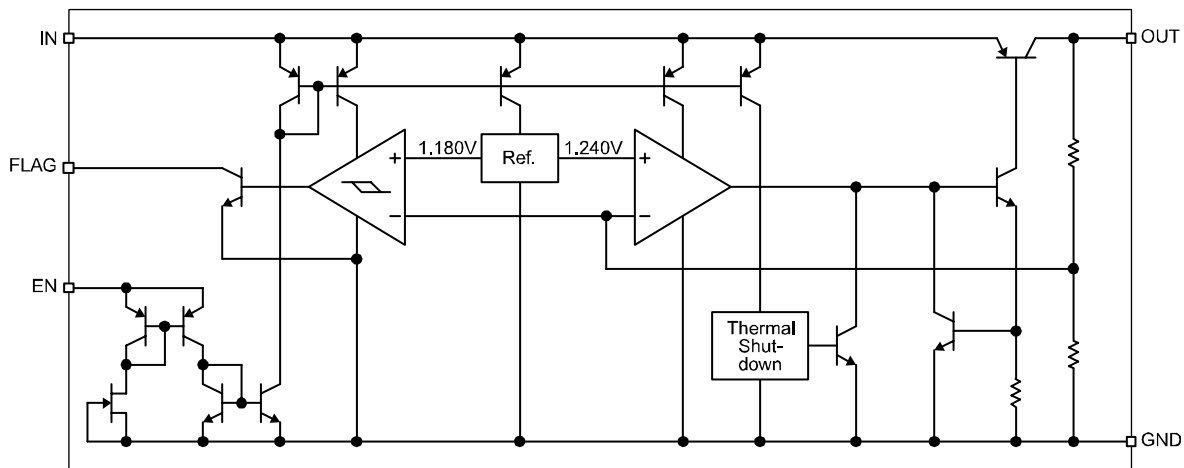

**MIC3775 Fixed Regulator with Flag and Enable Block Diagram**

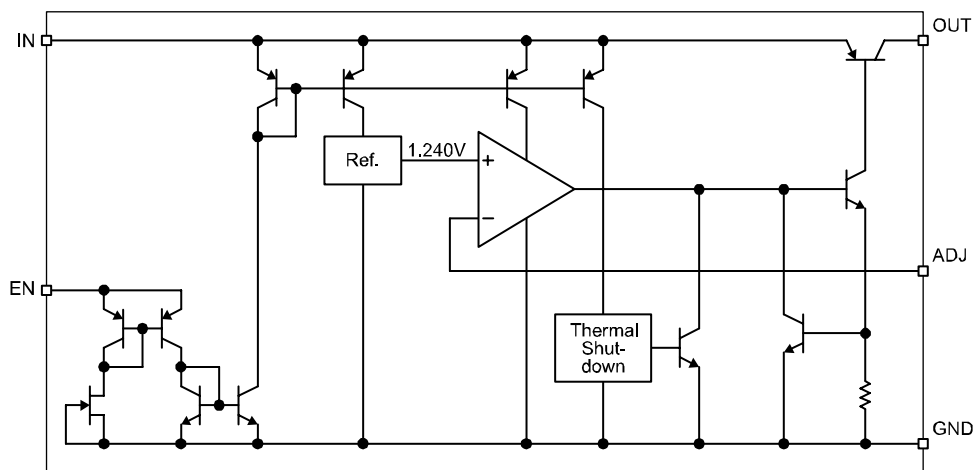

**MIC3775 Adjustable Regulator Block Diagram**

## Application Information

The MIC3775 is a high-performance low-dropout voltage regulator suitable for moderate to high-current voltage regulator applications. Its 500mV dropout voltage at full load and overtemperature makes it especially valuable in battery-powered systems and as high-efficiency noise filters in post-regulator applications. Unlike older NPN-pass transistor designs, where the minimum dropout voltage is limited by the base-to-emitter voltage drop and collector-to-emitter saturation voltage, dropout performance of the PNP output of these devices is limited only by the low  $V_{CE}$  saturation voltage.

A trade-off for the low-dropout voltage is a varying base drive requirement. Micrel's SuperBeta PNP<sup>®</sup> process reduces this drive requirement to only 2% of the load current.

The MIC3775 regulator is fully protected from damage due to fault conditions. Linear current limiting is provided. Output current during overload conditions is constant. Thermal shutdown disables the device when the die temperature exceeds the maximum safe operating temperature. The output structure of these regulators allows voltages in excess of the desired output voltage to be applied without reverse current flow.

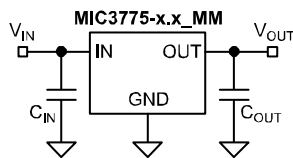

Figure 1. Capacitor Requirements

### Output Capacitor

The MIC3775 requires an output capacitor for stable operation. As a  $\mu$ Cap LDO, the MIC3775 can operate with ceramic output capacitors as long as the amount of capacitance is 10 $\mu$ F or greater. For values of output capacitance lower than 10 $\mu$ F, the recommended ESR range is 200m $\Omega$  to 2 $\Omega$ . The minimum value of output capacitance recommended for the MIC3775 is 4.7 $\mu$ F.

For 10 $\mu$ F or greater the ESR range recommended is less than 1 $\Omega$ . Ultra-low ESR ceramic capacitors are recommended for output capacitance of 10 $\mu$ F or greater to help improve transient response and noise reduction at high frequency. X7R/X5R dielectric-type ceramic capacitors are recommended because of their temperature performance. X7R-type capacitors change capacitance by 15% over their operating temperature range and are the most stable type of ceramic capacitors. Z5U and Y5V dielectric capacitors change value by as much as 50% and 60% respectively over their operating temperature ranges. To use a ceramic chip capacitor with Y5V dielectric, the value must be much higher than an X7R ceramic capacitor to ensure

the same minimum capacitance over the equivalent operating temperature range.

### Input Capacitor

An input capacitor of 1 $\mu$ F or greater is recommended when the device is more than 4 inches away from the bulk AC supply capacitance or when the supply is a battery. Small, surface mount, ceramic chip capacitors can be used for bypassing. Larger values will help to improve ripple rejection by bypassing the input to the regulator, further improving the integrity of the output voltage.

### Error Flag

The MIC3775 features an error flag (FLG), which monitors the output voltage and signals an error condition when this voltage drops 5% below its expected value. The error flag is an open-collector output that pulls low under fault conditions and may sink up to 10mA. Low output voltage signifies a number of possible problems, including an overcurrent fault (the device is in current limit) or low input voltage. The flag output is inoperative during overtemperature conditions. A pull-up resistor from FLG to either  $V_{IN}$  or  $V_{OUT}$  is required for proper operation. For information regarding the minimum and maximum values of pull-up resistance, refer to the graph in the "Typical Characteristics" section of the data sheet.

### Enable Input

The MIC3775 features an active-high enable input (EN) that allows on-off control of the regulator. Current drain reduces to "zero" when the device is shutdown, with only microamperes of leakage current. The EN input has TTL/CMOS compatible thresholds for simple logic interfacing. EN may be directly tied to  $V_{IN}$  and pulled up to the maximum supply voltage.

### Transient Response and 3.3V to 2.5V or 2.5V to 1.8V or 1.65V Conversion

The MIC3775 has excellent transient response to variations in input voltage and load current. The device has been designed to respond quickly to load current variations and input voltage variations. Large output capacitors are not required to obtain this performance. A standard 10 $\mu$ F output capacitor, is all that is required. Larger values help to improve performance even further.

By virtue of its low-dropout voltage, this device does not saturate into dropout as readily as similar NPN-based designs. When converting from 3.3V to 2.5V or 2.5V to 1.8V or 1.65V, the NPN-based regulators are already operating in dropout, with typical dropout requirements of 1.2V or greater. To convert down to 2.5V or 1.8V without operating in dropout, NPN-based regulators require an input voltage of 3.7V at the very least. The MIC3775 regulator will provide excellent performance

with an input as low as 3.0V or 2.5V respectively. This gives the PNP-based regulators a distinct advantage over older, NPN-based linear regulators.

**Minimum Load Current**

The MIC3775 regulator is specified between finite loads. If the output current is too small, leakage currents dominate and the output voltage rises. A 10mA minimum load current is necessary for proper regulation.

**Adjustable Regulator Design**

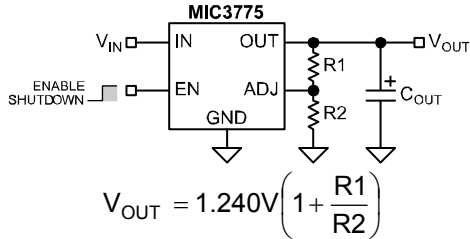

**Figure 2. Adjustable Regulator with Resistors**

The MIC3775 allows programming the output voltage anywhere between 1.24V and the 6V maximum operating rating of the family. Two resistors are used. Resistors can be quite large, up to 1MΩ, because of the very high input impedance and low bias current of the sense comparator. The resistor values are calculated by:

$$R1 = R2 \left( \frac{V_{OUT}}{1.240} - 1 \right)$$

Where  $V_O$  is the desired output voltage. Figure 2 shows component definition. Applications with widely varying load currents may scale the resistors to draw the minimum load current required for proper operation (see above).

**Power MSOP-8 Thermal Characteristics**

One of the secrets of the MIC3775's performance is its power MSOP-8 package featuring half the thermal resistance of a standard MSOP-8 package. Lower thermal resistance means more output current or higher input voltage for a given package size.

Lower thermal resistance is achieved by joining the four ground leads with the die attach paddle to create a single-piece electrical and thermal conductor. This concept has been used by MOSFET manufacturers for years, proving very reliable and cost effective for the user.

Thermal resistance consists of two main elements,  $\theta_{JC}$  (junction-to-case thermal resistance) and  $\theta_{CA}$  (case-to-ambient thermal resistance). See Figure3.  $\theta_{JC}$  is the resistance from the die to the leads of the package.  $\theta_{CA}$  is the resistance from the leads to the ambient air and it includes  $\theta_{CS}$  (case-to- sink thermal resistance) and  $\theta_{SA}$  (sink-to-ambient thermal resistance).

Using the power MSOP-8 reduces the  $\theta_{JC}$  dramatically and allows the user to reduce  $\theta_{CA}$ . The total thermal resistance,  $\theta_{JA}$  (junction-to-ambient thermal resistance) is the limiting factor in calculating the maximum power dissipation capability of the device. Typically, the power MSOP-8 has a  $\theta_{JA}$  of 80°C/W, this is significantly lower than the standard MSOP-8 which is typically 160°C/W.  $\theta_{CA}$  is reduced because pins 5 through 8 can now be soldered directly to a ground plane which significantly reduces the case-to-sink thermal resistance and sink-to-ambient thermal resistance.

Low-dropout linear regulators from Micrel are rated to a maximum junction temperature of 125°C. It is important not to exceed this maximum junction temperature during operation of the device. To prevent this maximum junction temperature from being exceeded, the appropriate ground plane heatsink must be used.

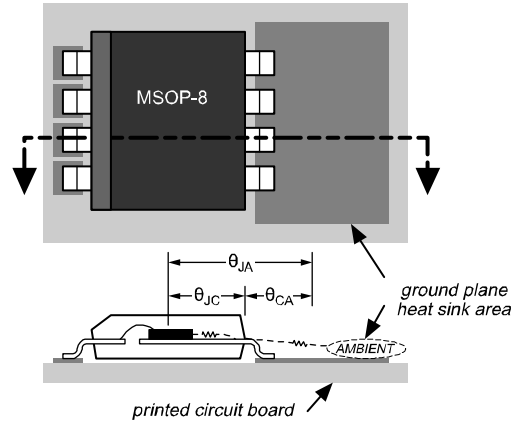

**Figure 3. Thermal Resistance**

Figure 4 shows copper area versus power dissipation with each trace corresponding to a different temperature rise above ambient.

From these curves, the minimum area of copper necessary for the part to operate safely can be determined. The maximum allowable temperature rise must be calculated to determine operation along which curve.

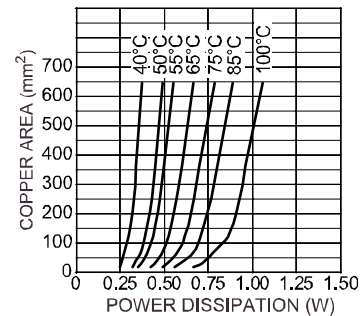

**Figure 4. Copper Area vs. Power-MSOP Power Dissipation ( $\Delta T_{JA}$ )**

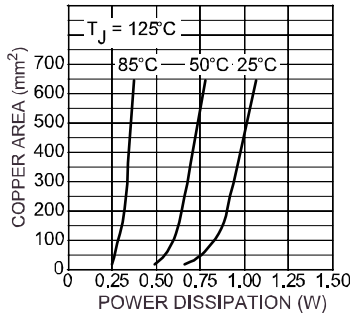

**Figure 5. Copper Area vs. Power-MSOP Power Dissipation (T<sub>A</sub>)**

$$\Delta T = T_{J(max)} - T_{A(max)}$$

$$T_{J(max)} = 125^{\circ}C$$

$$T_{A(max)} = \text{maximum ambient operating temperature}$$

For example, the maximum ambient temperature is 50°C, the ΔT is determined as follows:

$$\Delta T = 125^{\circ}C - 50^{\circ}C$$

$$\Delta T = 75^{\circ}C$$

Using Figure 4, the minimum amount of required copper can be determined based on the required power dissipation. Power dissipation in a linear regulator is calculated as follows:

$$P_D = (V_{IN} - V_{OUT}) I_{OUT} + V_{IN} \times I_{GND}$$

If we use a 2.5V output device and a 3.3V input at an output current of 750mA, then our power dissipation is as follows:

$$P_D = (3.3V - 2.5V) \times 750mA + 3.3V \times 7.5mA$$

$$P_D = 600mW + 25mW$$

$$P_D = 625mW$$

From Figure 4, the minimum amount of copper required to operate this application at a ΔT of 75°C is 160mm<sup>2</sup>.

**Quick Method**

Determine the power dissipation requirements for the design along with the maximum ambient temperature at which the device will be operated. Refer to Figure 5, which shows safe operating curves for three different ambient temperatures: 25°C, 50°C and 85°C. From these curves, the minimum amount of copper can be determined by knowing the maximum power dissipation required. If the maximum ambient temperature is 50°C and the power dissipation is as above, 625mW, the curve in Figure 5 shows that the required area of copper is 160mm<sup>2</sup>. The θ<sub>JA</sub> of this package is ideally 80°C/W, but it will vary depending upon the availability of copper ground plane to which it is attached.

# Package Information

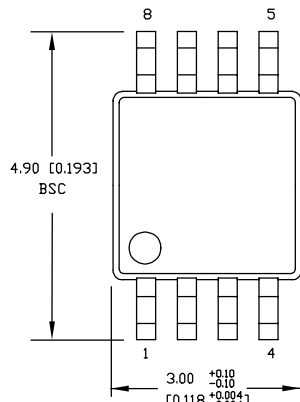

TOP VIEW

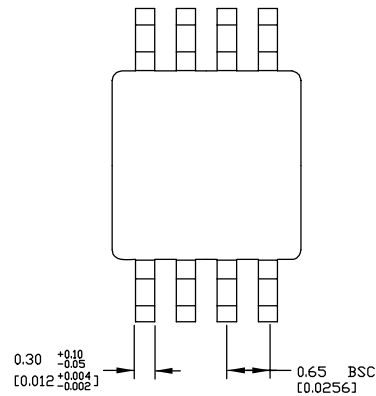

BOTTOM VIEW

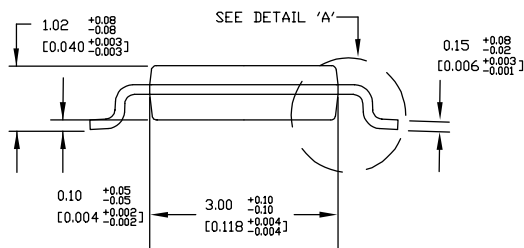

SIDE VIEW

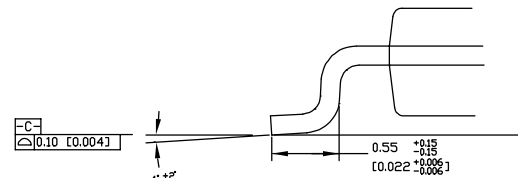

DETAIL A

**NOTES:**

1. DIMENSIONS ARE IN MM [INCHES].
2. CONTROLLING DIMENSION: MM
3. DIMENSION DOES NOT INCLUDE MOLD FLASH OR PROTRUSIONS, EITHER OF WHICH SHALL NOT EXCEED 0.20 [0.008] PER SIDE.

**8-Pin MSOP (MM)**

**MICREL, INC. 2180 FORTUNE DRIVE SAN JOSE, CA 95131 USA**  
 TEL +1 (408) 944-0800 FAX +1 (408) 474-1000 WEB <http://www.micrel.com>

The information furnished by Micrel in this data sheet is believed to be accurate and reliable. However, no responsibility is assumed by Micrel for its use. Micrel reserves the right to change circuitry and specifications at any time without notification to the customer.

Micrel Products are not designed or authorized for use as components in life support appliances, devices or systems where malfunction of a product can reasonably be expected to result in personal injury. Life support devices or systems are devices or systems that (a) are intended for surgical implant into the body or (b) support or sustain life, and whose failure to perform can be reasonably expected to result in a significant injury to the user. A Purchaser's use or sale of Micrel Products for use in life support appliances, devices or systems is a Purchaser's own risk and Purchaser agrees to fully indemnify Micrel for any damages resulting from such use or sale.

© 2002 Micrel, Incorporated.