

Mini Hi-Fi Component System

Operating Instructions



***MHC-GNV111D
MHC-GNV99D***

WARNING

To prevent fire or shock hazard, do not expose the unit to rain or moisture.

To prevent fire, do not cover the ventilation of the apparatus with newspapers, table-cloths, curtains, etc. And don't place lighted candles on the apparatus.

To prevent fire or shock hazard, do not place objects filled with liquids, such as vases, on the apparatus.

To avoid electrical shock, do not open the cabinet.

Refer servicing to qualified personnel only.

Do not install the appliance in a confined space, such as a bookcase or built-in cabinet.

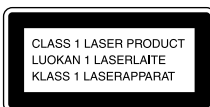

This appliance is classified as a CLASS 1 LASER product. This label is located on the rear exterior.



ENERGY STAR® is a U.S. registered mark. As an ENERGY STAR® partner, Sony Corporation has determined that this product meets the ENERGY STAR® guidelines for energy efficiency.

The following caution label is located inside the apparatus.



Table of Contents

About this manual	5
Playable discs.....	6

Getting Started

Hooking up the system.....	9
Positioning the speakers.....	13
Setting the clock.....	14
Performing QUICK SETUP	14

Disc – Playback

Loading a disc	16
Playing a disc	16
— Normal Play	
Playing in random order.....	19
— Shuffle Play	
Playing repeatedly.....	20
— Repeat Play	
Creating your own program	21
— Program Play	
Playing DVD VIDEOS using the menu	23
Selecting “ORIGINAL” or “PLAY LIST” on a DVD-RW.....	23
Playing VIDEO CDs with PBC functions (Version 2.0).....	24
— PBC Playback	
About MP3 audio tracks and JPEG image files.....	25
Playing DATA CDs with MP3 audio tracks and JPEG image files	27
Playing MP3 audio tracks and JPEG image files as a slide show with sound.....	30
Enjoying DivX [®] video files	32
(Except for Latin American models)	
Searching for a particular point on a disc	34
— Scan, Slow-motion Play, Freeze Frame	
Using the on-screen display to search for a title/chapter/scene/track/ index/album/file.....	35
Searching by scene.....	37
— Picture Navigation	

Disc – Various functions

Changing the sound/subtitle/ language	38
Adjusting the angle/image	42
Adjusting the delay time between the picture and sound	44
— A/V SYNC	
Restricting playback of the disc.....	45
— CUSTOM PARENTAL CONTROL/PARENTAL CONTROL	
Speaker settings	49
— SPEAKER SETUP	
Using the THEATRE SYNC function.....	53
Changing the format of the video signal from COMPONENT VIDEO OUT jacks.....	54
List of items that can be displayed and selected by disc type.....	56
System setup item list	58

Tuner

Presetting radio stations.....	59
Listening to the radio.....	61

Tape – Playback

Loading a tape	62
Playing a tape.....	62

Tape – Recording

Recording your favorite tracks on a disc into a tape	63
— CD Synchro Recording	
Recording on a tape manually	64
— Manual Recording	

continued

Sound Adjustment

Adjusting the sound	65
Selecting the preset effect	66
Adjusting the graphic equalizer and storing the user equalizer setting	66
Selecting the sound field	67
Flashing sound effect	68
— SOUND FLASH	
Creating a party environment.....	69
(MHC-GNV111D only)	
Listening to the sound in another room.....	70
(MHC-GNV111D only)	
Singing along: Karaoke.....	70
Mixing and recording sounds.....	75

Timer

Falling asleep to music.....	76
— Sleep Timer	
Waking up to music	76
— Play Timer	
Timer recording radio programs	78

Display

Turning off the display.....	79
— Power Saving Mode	
Changing the spectrum analyzer display.....	80
Adjusting the brightness of the front panel display	80
Changing the power illuminator	81
Viewing information about the disc in the front panel display	81
Viewing information about the disc in the on-screen display	83
Checking the date information of JPEG image files.....	84

Optional Components

Hooking up optional components.....	85
Listening to audio from a connected component	87
Recording audio signal from a connected component.....	87
Recording audio signal on a connected component	88
Connecting external antennas	88

Troubleshooting

Problems and remedies	89
Self-diagnosis Function	94
Messages.....	95

Additional Information

Precautions	96
Specifications	98
Language code list	101
Glossary	102
List of button locations and reference pages.....	106

About this manual

- The instructions in this manual are for models MHC-GNV111D and MHC-GNV99D. In this manual, the MHC-GNV111D is used for illustration purposes unless stated otherwise.

The MHC-GNV111D consists of:







- Tuner/DVD player/Stereo cassette deck/Amplifier (unit) HCD-GNV111D
- Speaker System
 - Front speakers SS-GNV111D
 - Surround speakers SS-RSV111D
 - Center speaker SS-CT111D

The MHC-GNV99D consists of:

- Tuner/DVD player/Stereo cassette deck/Amplifier (unit) HCD-GNV99D
- Speaker System
 - Front speakers SS-GNV111D
 - Surround speakers SS-RSV99D
 - Center speaker SS-CT99D

- This manual mainly explains operations using the buttons on the remote, but the same operations can also be performed using the buttons on the unit having the same or similar names.
- The English on-screen display is used for illustration purposes only.
- The on-screen display may vary depending on the area.
- The Control Menu items may differ depending on the area.

- The following symbols are used in this manual.

Symbol	Meaning
	Functions available for DVD VIDEOS (including DVD-Rs/ DVD-RWs/DVD+Rs/ DVD+RWs in DVD VIDEO format).
	Functions available for DVD-RWs in VR (Video Recording) mode.
	Functions available for VIDEO CDs (including Super VCDs and CD-Rs/CD-RWs in VIDEO CD or Super VCD format).
	Functions available for AUDIO CDs (including CD-Rs/CD-RWs in AUDIO CD format).
	Functions available for DATA CDs (CD-ROMs/CD-Rs/ CD-RWs) containing MP3 ¹⁾ audio tracks, JPEG image files or DivX ²⁾³⁾⁴⁾ video files.
	Functions available for DATA DVDs (DVD-Rs/DVD-RWs/ DVD+Rs/DVD+RWs) containing DivX ²⁾³⁾⁴⁾ video files.

¹⁾MP3 (MPEG 1 Audio Layer 3) is a standard format defined by ISO/MPEG which compresses audio data.

²⁾DivX[®] is a video file compression technology, developed by DivXNetworks, Inc.

³⁾DivX, DivX Certified, and associated logos are trademarks of DivXNetworks, Inc. and are used under license.

⁴⁾Except for Latin American models.

Playable discs

You can play back the following discs on this system. Other discs cannot be played back.

List of playable discs

Format of discs	Disc logo
DVD VIDEO	
DVD-RW	
VIDEO CD	
AUDIO CD	 
CD-R/CD-RW	   

The “DVD VIDEO” and “DVD-RW” logos are trademarks.

Note about discs

- The system can play back CD-ROMs/CD-Rs/CD-RWs recorded in the following formats:
 - AUDIO CD format
 - VIDEO CD format
 - DATA CD format that contains MP3 audio tracks in MPEG 1 Audio Layer 3, JPEG image files and DivX video files* that conforms to ISO 9660 Level 1, Level 2 or Joliet in expansion format
- The system can play back DVD-Rs/DVD-RWs/DVD+Rs/DVD+RWs recorded in the following formats:
 - DVD VIDEO format
 - DATA DVD format that contains DivX video files that conforms to UDF (Universal Disk Format).*
- The system cannot play back the following discs:
 - CD-ROMs recorded in PHOTO CD format
 - Data part of CD-Extras
 - Super Audio CDs
 - DVD Audio discs
 - DVD-RAMs
 - DVD VIDEOS with a different region code
 - DVD-ROMs/DVD-Rs/DVD-RWs/DVD+Rs/ DVD+RWs recorded in Multi Session
 - Discs with non-standard shapes (e.g., heart, square, star)
 - Discs that has the adhesive, cellophane tape, or a sticker still left on it

* Except for Latin American models.

Region code of DVD VIDEOS you can playback on this system

Your system has a region code printed on the back of the unit and will only play back DVD VIDEOS labeled with identical region code. DVD VIDEOS labeled  will also be played back on this system.

If you try to play back any other region code DVD VIDEO, the message “Playback prohibited by area limitations.” will appear on the TV screen. Depending on the DVD VIDEO, no region code indication may be labeled even though playing the DVD VIDEO is prohibited by area restrictions.

Example:

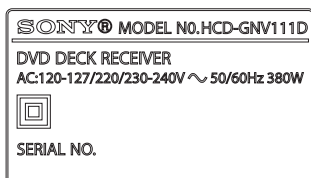

Region code



Notes about CD-R/CD-RW/ DVD-R/DVD-RW/DVD+R/ DVD+RW

- In some cases, CD-Rs/CD-RWs/DVD-Rs/ DVD-RWs/DVD+Rs/DVD+RWs cannot be played back on this system due to the recording quality or physical condition of the disc, or the characteristics of the recording device. The disc will not be played back if it has not been correctly finalized. For more information, see the operation instructions for the recording device.
- A disc created in Packet Write format cannot be played back.

Note on playback operations of DVD VIDEOS and VIDEO CDs

Some playback operations of DVD VIDEOS and VIDEO CDs may be intentionally set by software producers. Since this system play back DVD VIDEOS and VIDEO CDs according to the disc contents the software producers designed, some playback features may not be available. Also, refer to the instructions supplied with the DVD VIDEOS or VIDEO CDs.

Note on DualDiscs

A DualDisc is a two sided disc product which mates DVD VIDEO recorded material on one side with digital audio material on the other side. However, since the audio material side does not conform to Compact Disc (CD) standard, playback on this product is not guaranteed.

Music discs encoded with copyright protection technologies

This product is designed to play back discs that conform to the Compact Disc (CD) standard. Recently, various music discs encoded with copyright protection technologies are marketed by some record companies. Please be aware that among those discs, there are some that do not conform to the CD standard and may not be playable by this product.

Note on PBC (Playback Control) (VIDEO CDs)

This system conforms to Ver. 1.1 and Ver. 2.0 of VIDEO CD standards. You can enjoy two kinds of playback depending on the disc type.

Disc type	You can
VIDEO CDs without PBC functions (Ver. 1.1 discs)	Enjoy video playback (moving pictures) as well as music.
VIDEO CDs with PBC functions (Ver. 2.0 discs)	Play back interactive software using menu screens displayed on the TV screen (PBC Playback), in addition to the video playback functions of Ver. 1.1 discs. Moreover, you can play back high-resolution still pictures, if they are included on the disc.

Note about Multi Session Disc

- This system can play back Multi Session discs when an MP3 audio track is contained in the first session. Any subsequent MP3 audio tracks recorded in later sessions can also be played back.
- This system can play back Multi Session discs when a JPEG image file is contained in the first session. Any subsequent JPEG image files recorded in later sessions can also be played back.
- If audio tracks and images in AUDIO CD format or VIDEO CD format are recorded in the first session, only the first session will be played back.
- This system recognize the Multi Session disc as AUDIO CD if AUDIO CD exists in any one of the session, only the first session will be played back.
- CD-R/CD-RW recorded in Multi Session that have not ended by “closing the session” are not supported.

- With DATA CD that contains DivX video files in addition to MP3 audio tracks or JPEG image files, the system only play back the DivX video files.
- With DATA DVD, the system play back DivX video files only. Any data other than DivX video files, such as MP3 audio tracks and JPEG image files, are not played back.

Copyrights

This product incorporates copyright protection technology that is protected by U.S. patents and other intellectual property rights. Use of this copyright protection technology must be authorized by Macrovision, and is intended for home and other limited viewing uses only unless otherwise authorized by Macrovision. Reverse engineering or disassembly is prohibited.

This system incorporates Dolby* Digital, Dolby Pro Logic (II) adaptive matrix surround decoder, and the DTS** Digital Surround System.

* Manufactured under license from Dolby Laboratories.
“Dolby”, “Pro Logic”, and the double-D symbol are trademarks of Dolby Laboratories.

**Manufactured under license from Digital Theater Systems, Inc, “DTS” and “ DTS Digital Surround” are registered trademarks of Digital Theater Systems. Inc.

Hooking up the system

Do the following procedures **1** to **8** to hook up your system using the supplied cords and accessories (page 100).

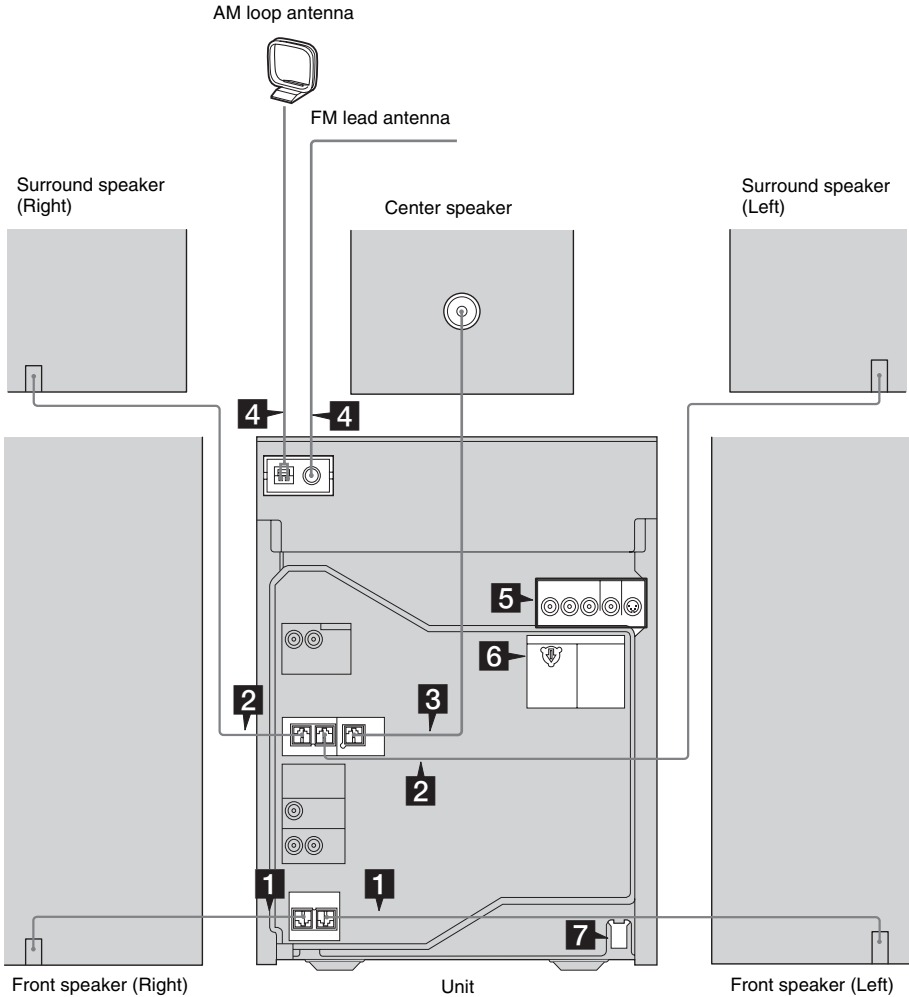

1 Connect the front speakers.

Connect the speaker cords of the front speakers to the FRONT SPEAKER terminals as shown below.

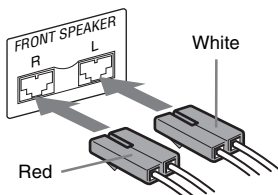

2 Connect the surround speakers.

Connect the speaker cords of the surround speakers to the SURR SPEAKER terminals as shown below.

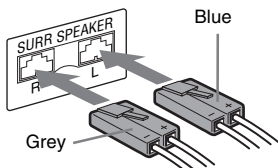

Tip

MHC-GNV99D (SS-RSV99D) only
Connect the speaker cords to the terminals on the speakers.

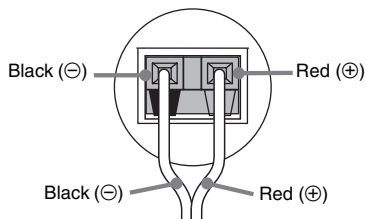

3 Connect the center speaker.

Connect the speaker cord of the center speaker to the CENTER SPEAKER terminal as shown below.

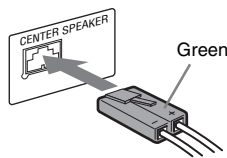

4 Connect the FM and AM antennas.

Set up the AM loop antenna, then connect it.

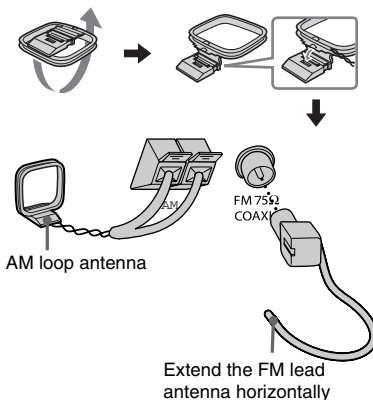

5 Connect the video input jack of your TV to the VIDEO OUT jack with the supplied video cord.

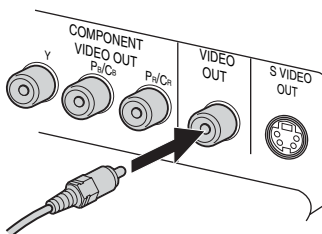

When using a TV

Turn on the TV and select the video input so that you can view the pictures from this system.

When connecting a video deck

Connect the video deck to the TV using a video cord (not supplied). However, do not connect this unit to the TV through the video deck.

Otherwise, you may experience video leakage when watching video images from this system. Connect this unit directly to the TV as shown below.

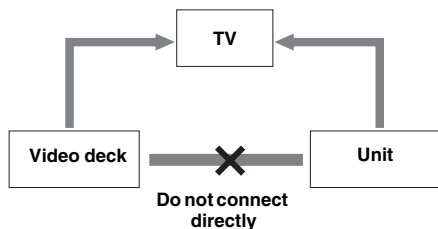

Tip

For even higher quality video images:

- Use optional component video cords to connect the COMPONENT VIDEO input jacks on your TV to the COMPONENT VIDEO OUT jacks of this unit. If your TV is compatible with progressive format file signals, use this connection and press PROGRESSIVE on the unit repeatedly until “P AUTO” or “P VIDEO” appears in the display (page 54).
- You can use an optional S Video cord to connect the S VIDEO input jack on your TV to the S VIDEO OUT jack of this unit.

6 For models equipped with a voltage selector, set VOLTAGE SELECTOR to the position of your local power line voltage.

Depending on the model, the VOLTAGE SELECTOR may differ.

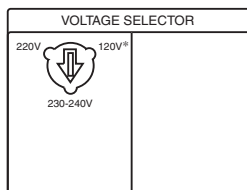

* Saudi Arabian model : 120 - 127V

7 Connect the power cord to a wall outlet.

The demonstration appears in the display. When you press I/⏻, the system turns on and the demonstration automatically ends. If the supplied adaptor on the plug does not fit your wall outlet, detach it from the plug (only for models equipped with an adaptor).

8 (Except for Latin American and Russian models) Set the color system to PAL or NTSC depending on the color system of your TV.

The default setting for color system is different depending on the area.

Each time you perform the procedure below, the color system changes as follows:
NTSC ↔ PAL

Use buttons on the unit for the operation.

- 1 Press I/⏻ to turn off the system for the operation.
- 2 Press I/⏻ while holding down III.

The system turns on automatically and the color system is changed.

“COLOR NTSC” or “COLOR PAL” appears in the display.

Notes

- Keep the speaker cords away from the antennas to prevent noise.
- Be sure to match the color of the speaker terminals on the unit and the connectors.
- Be sure to connect the speakers securely and correctly. When connecting speaker cords, insert the connector straight into the terminals.
- The type of speakers supplied vary according to the model you purchased (see “Specifications” on page 98).
- You cannot set the color system in the Power Saving Mode (see “Turning off the display” on page 79).
- When you play back a VIDEO CD recorded in a different color system from the one you set to the unit, the picture image may be distorted.

To connect optional components

See “Hooking up optional components” on page 85.

Inserting two R6 (size AA) batteries into the remote

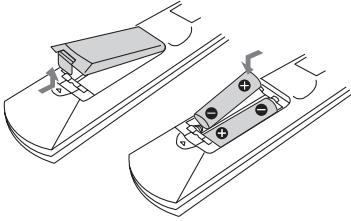

Operating a Sony TV

You can use the following orange printing buttons to operate a Sony TV.

To use the buttons with orange printing, press TV and the button you want simultaneously.

To	Press
Turn the TV on or off	TV I/⏻
Switch the TV's input source between the TV and other input sources	TV/VIDEO
Select the TV channels	TV CH +/- or numeric buttons*
Adjust the volume of the TV speaker(s)	TV VOL +/-

* To select the TV channels with channel number more than 10, press -/-. then press numeric buttons.

Note

If you do not use the remote for a long period of time, remove the batteries to avoid possible damage from battery leakage and corrosion.

Tip

With normal use, the batteries should last for about six months. When the remote no longer operates the system, replace both batteries with new ones.

Attaching the speaker pads

Attach the supplied speaker pads to the bottom of the speakers to stabilize the speakers and to prevent them from slipping.

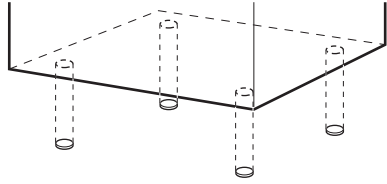

When carrying the unit

Do the following procedure to protect the disc mechanism.

Use buttons on the unit for the operation.

- 1 Press I/⏻ to turn on the system.
- 2 Press DVD.
- 3 Press ▲ OPEN/CLOSE to open the disc tray and remove the disc. If there are more than one disc in the disc tray, press EX-CHANGE/DISC SKIP to remove the discs.
- 4 Press ▲ OPEN/CLOSE again to close the disc tray. Wait until the "DVD No Disc" appears in the display.
- 5 Hold down DVD and then press I/⏻ until "STANDBY" appears in the display. Then, "MECHA LOCK" appears in the display.
- 6 Unplug the AC power cord.

Positioning the speakers

For MHC-GNV99D

Place the front speakers at an angle of 45 degrees from your listening position.

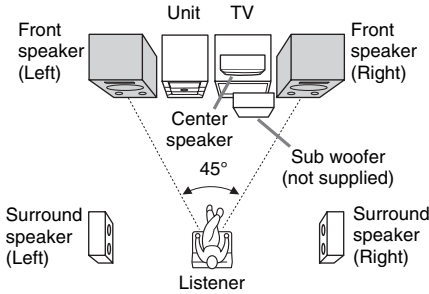

For MHC-GNV111D

There are 2 different ways to place the speakers. To enjoy and create a party environment, we recommend that you place your speakers as shown in Example 1.

Example 1

Place the speakers at an equal distance (A) from your listening position as shown below.

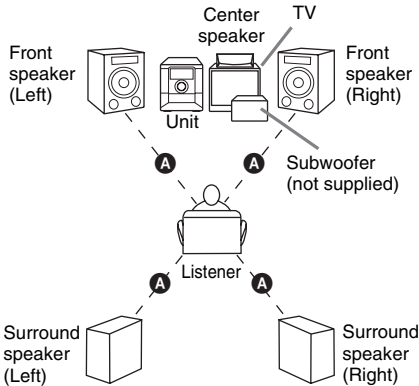

Example 2

Place the surround speakers beside the front speakers as shown below.

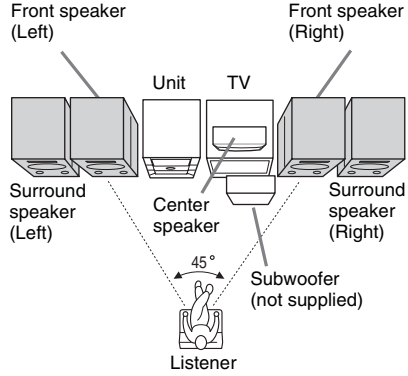

Notes

- Do not place the surround speakers on top of a TV. This may cause distortion of the colors in the TV screen.
- If you place the center speaker on the unit, be sure to place it at the front side of the unit.
- Place the subwoofer on solid floor where resonance is unlikely to occur so that a better bass reproduction could be obtained.
- Always place the subwoofer vertically, keeping it a few centimeters away from the wall.
- If the subwoofer is placed in the center of a room, the bass could be extremely weakened. This is due to the influence of the standing wave of the room. If this happens, move the subwoofer away from the center of the room or eliminate the cause of the standing wave, by placing a bookshelf against the wall, etc.

Tip

You can enjoy 5.1 channel surround sound while playing a DVD VIDEO. To adjust the speaker volume and level, see page 52.

Speaker settings

To enjoy multi-channel source sound and Dolby surround effects, adjust the speakers distance and level, see "Speakers settings" on page 49.

Setting the clock

- 1 Press I/⏻ to turn on the system.**
- 2 Press TIMER MENU.**
The hour indication flashes in the display.
- 3 Press ↑ or ↓ repeatedly to set the hour.**
- 4 Press ENTER.**
The minute indication flashes in the display.
- 5 Press ↑ or ↓ repeatedly to set the minute.**
- 6 Press ENTER.**
The clock starts functioning.

To adjust the clock

- 1 Press TIMER MENU.**
“PLAY SET?” flashes in the display.
- 2 Press ↑ or ↓ repeatedly to select “CLOCK SET?”, then press ENTER.**
The hour indication flashes in the display.
- 3 Do the same procedures as step 3 to 6 above.**

Notes

- The clock settings are canceled when you disconnect the power cord or if a power failure occurs.
- You cannot set the clock in power saving mode (page 79).

Performing QUICK SETUP

You can set the initial settings of LANGUAGE SETUP, TV TYPE and SPEAKER SETUP step by step in QUICK SETUP. After performing the QUICK SETUP, the system is ready for playing back of movies, music CDs, etc. To perform further speakers settings, see “Speaker settings” on page 49.

- 1 Turn on your TV and select the video input.**

- 2 Press I/⏻ to turn on the system.**

Note

Make sure that the headphone or microphone is not connected. Otherwise, you cannot perform SPEAKER SETUP.

- 3 Press FUNCTION +/- repeatedly to select “DVD” (or press DVD on the unit).**

“Press **ENTER** to run QUICK SETUP.” guide message appears at the bottom of the on-screen display.

- 4 Press ENTER.**

The “LANGUAGE SETUP” display appears in the on-screen display.

LANGUAGE SETUP	
OSD:	ENGLISH
MENU:	ENGLISH
AUDIO:	FRENCH
SUBTITLE:	SPANISH
	PORTUGUESE

5 Press **↑** or **↓** repeatedly to select a language, then press **ENTER**.

The setting is selected and the “SCREEN SETUP” display appears in the on-screen display.

The language options are different depending on the area.

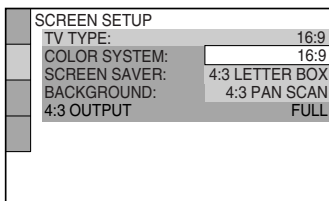

6 Press **↑** or **↓** repeatedly to select the setting that matches your TV type.

■ If you have a 4:3 standard TV

Select 4:3 LETTER BOX or 4:3 PAN SCAN (page 42)

■ If you have a wide-screen TV or a 4:3 standard TV with wide-screen mode

Select 16:9 (page 24)

7 Press **ENTER**.

The setting is selected and the “SPEAKER SETUP” display appears in the on-screen display.

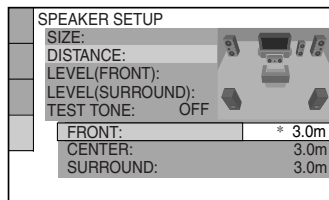

8 Press **↑** or **↓** repeatedly to select the front speaker distance from your listening position, then press **ENTER**.

You can set from 1.0 to 7.0 meters. Repeats this step to adjust center and surround speaker distance.

The setting is selected and “QUICK SETUP is complete.” appears in the on-screen display.

If you make a mistake

Press **DISPLAY**, then repeat step 1 to 8.

To quit QUICK SETUP

Press **DISPLAY**.

To change the settings of QUICK SETUP

- Press **DISPLAY** when playback is stopped. The Control Menu appears in the on-screen display.
- Press **↑** or **↓** repeatedly to select **(SETUP)**, then press **ENTER**.
- Press **↑** or **↓** repeatedly to select “QUICK”, then press **ENTER**. The “LANGUAGE SETUP” display appears in the on-screen display.
- Do the same procedures as step 5 to 8 of “Performing QUICK SETUP”.

Notes

- The guide message appears at the bottom of on-screen display when you turn on the system for the first time or after performing “RESET” (see “To return the DVD setup to the default settings”, perform reset as follows:” on page 94).
- If you do not want to perform QUICK SETUP, press **CLEAR** in step 3. The guide messages will disappear from the on-screen display.
- When there is a disc in the unit or the disc tray is opened, the guide message does not appear in the on-screen display. To perform QUICK SETUP, press **OPEN/CLOSE** on the unit to remove the disc and press **OPEN/CLOSE** on the unit again to close the disc tray.
- If you want to change each setting individually, see “Disc – Various functions” on page 38.

Disc – Playback

Loading a disc

Use buttons on the unit for the operation.

- 1 Press \blacktriangle OPEN/CLOSE.**
The disc tray slides out.
- 2 Load a disc with the label side facing up on the disc tray.**

When you play back a 8 cm disc such as CD single, place it on the inner circle of the tray

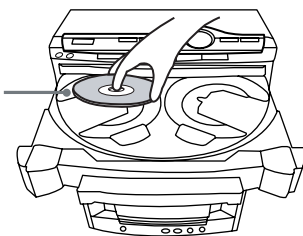

To load additional discs, press EX-CHANGE/DISC SKIP to rotate the disc tray.

- 3 Press \blacktriangle OPEN/CLOSE to close the disc tray.**

Notes

- Do not push the disc tray when closing it as this may cause malfunction. Press \blacktriangle OPEN/CLOSE to close the disc tray.
- Do not use a disc with tape, seals or paste on it as this may cause malfunction.

Playing a disc

— Normal Play



Before playing a DVD VIDEO, a VIDEO CD, a JPEG image file or a DivX video file, turn on your TV and select the video input. Depending on the DVD VIDEO or VIDEO CD, some operations may be different or restricted. Refer to the operating instructions supplied with the disc.

When playing a DVD VIDEO:

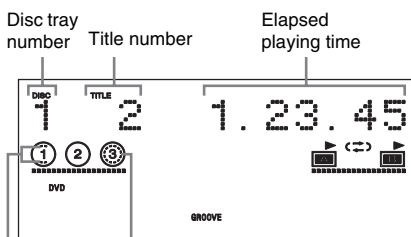

Disc playing indicator Disc presence indicator

When playing a VIDEO CD (playback without PBC function):

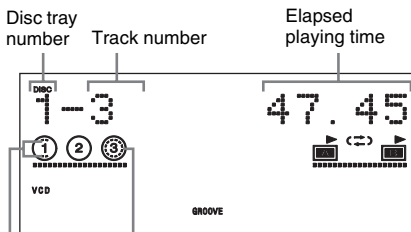

Disc playing indicator Disc presence indicator

When playing an AUDIO CD:

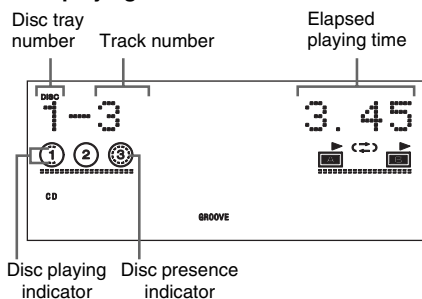

When playing an MP3 audio track:

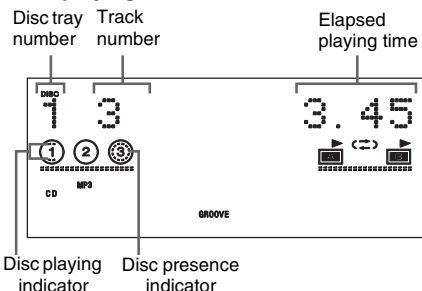

When playing a DivX video file (in DATA DVD):

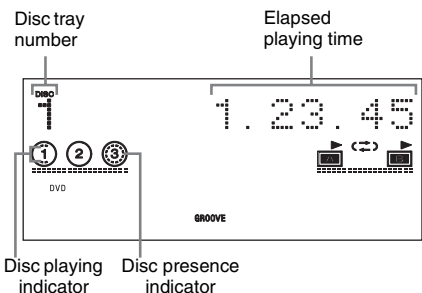

1 Press **FUNCTION +/-** repeatedly to select “DVD” (or press DVD on the unit).

2 Press **>** (or **<>** on the unit).

Other operations

To	Do this
Stop playback	Press ■ .
Pause playback	Press . Press again or > (or <> on the unit) to resume playback.
Select a track ¹⁾ , chapter or video file	Turn ◀▶ or ▶▶ repeatedly (or turn ◀▶▶▶ on the unit clockwise or counterclockwise) during playback.
Select an album ²⁾	Press ALBUM +/- repeatedly during playback or when playback is paused.
Replay the previous scene ³⁾⁴⁾	Press REPLAY ◀• during playback.
Briefly fast forward the current scene ³⁾⁴⁾	Press ADVANCE •▶ during playback.
Select a disc when playback is stopped	Press DISC SKIP (or one of the DISC 1 ~ 3 buttons on the unit).
Switch to DVD function from another source and start playback automatically	Press one of the DISC 1 ~ 3 buttons on the unit (Automatic Source Selection).
Exchange other discs while playing	Press EX-CHANGE/DISC SKIP on the unit.
Remove the disc	Press ▲ OPEN/CLOSE on the unit.

1) You cannot select an audio track during Lock Search operation of MP3 audio tracks.

2) MP3 audio tracks, JPEG image files and DivX video files only.

3) DVD VIDEOS and DVD-RWs in VR mode only.

4) This operation only available when “REPEAT” is set to “OFF”.

Note

Depending on the DVD VIDEO or VIDEO CD, some operations may be restricted.

Tips

If you press DVD on the unit while the system is turned off, the system turns on automatically and “DVD” is selected as the function.

Resuming playback from the point you stopped the disc

— Resume Play



This system memorizes the point where you stopped the disc so you can resume from that point. Resume Play is not canceled when you turn off the system except for MP3 audio tracks, JPEG image files and DivX video files.

1 While playing a disc, press **■** to stop playback.

“Resume” appears in the display. If “Resume” does not appear, Resume Play is not available.

2 Press **▷** (or **◀▶** on the unit).

The system starts playback from the point you stopped the disc in step 1.

Notes

- You cannot perform Resume Play during Shuffle Play or Program Play.
- Depending on where you stopped the disc, the system may resume playback from a different point.
- Resume Play is canceled when you
 - press **■** when playback is stopped.
 - open the disc tray.
 - change the function.
 - change the settings in the Control Menu.
- Resume Play is not cancel for DVD VIDEO and VIDEO CD if the “MULTI-DISC RESUME” setting is “ON” during function change or when you open the disc tray.

Tip

To play back from the beginning of the disc, press **■** twice, then press **▷** (or **◀▶** on the unit).

To resume playback of the disc that is played back previously (Multi-disc Resume)



This system can store the point where you stopped the playback of the disc for up to 40 discs and resumes playback when you insert the same disc again. If you store a playback resume point for the 41st disc, the playback resume point for the first disc will be deleted.

To activate this function, set “MULTI-DISC RESUME” in “CUSTOM SETUP” to “ON”. For details, see “MULTI-DISC RESUME” on page 41.

Note

If “MULTI-DISC RESUME” in “CUSTOM SETUP” is set to “ON” (page 41) and you play back a recorded disc such as DVD-R, the system may play back other recorded discs from the same point. To play back from the beginning, press **■** twice and then press **▷** (or **◀▶** on the unit).

Playing a track, chapter or file by entering the track, the chapter or the file number

(DVD VIDEO, VIDEO CD, AUDIO CD and DivX video files only)

Press the numeric button(s) to enter the track, the chapter or the file number you want to play back when the Control Menu is turned off. Then, press ENTER.

To enter a track, a chapter or a file number over 10

1 Enter the corresponding digits.

2 Press ENTER.

Example:

To play back track, chapter or file number 30, press 3 and 0, then press ENTER.

Playing in random order

— Shuffle Play



You can play back the tracks on the current disc in random order. Each time you perform Shuffle Play, the playing order may differ.

1 Press DISPLAY during playback.

The Control Menu appears in the on-screen display.

2 Press or repeatedly to select (SHUFFLE), then press ENTER.

The options for “SHUFFLE” appear in the on-screen display.

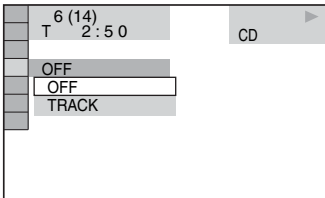

3 Press or repeatedly to select the item to be shuffled.

■ During Program Play is Off

- TRACK: all tracks on the current disc is played back randomly.

■ During Program Play is On

(see “Creating your own program” on page 21)

- ON: all tracks in Program Playlist is played back randomly.

4 Press ENTER

Shuffle Play starts.

“SHUF” lights up in the display and

indicator lights up in green when “TRACK” or “ON” is selected.

To cancel Shuffle Play

Press CLEAR or select “OFF” in step 3.

To turn off the Control Menu

Press DISPLAY repeatedly until the Control Menu disappears from the on-screen display.

Notes

- Shuffle Play only available for the tracks on the current disc.
- You cannot perform Shuffle Play during playback with PBC function of VIDEO CDs.
- Shuffle Play is canceled when
 - the disc tray is opened.
 - you press DISC SKIP (or one of the DISC 1 ~ 3 buttons on the unit) to select other disc.
 - you turn off the system.
 - you change the function.
 - you perform Track/Index Search.

Tip

You can also change the Shuffle Play setting when the playback is stopped.

Playing repeatedly

— Repeat Play



You can play back all the titles, tracks, files or a single title, chapter, track or file on a disc repeatedly.

You can set the Shuffle Play to “ON” during Program Play is set to “ON”.

1 Press DISPLAY during playback.

The Control Menu appears in the on-screen display.

2 Press or repeatedly to select (REPEAT), then press ENTER.

The options for “REPEAT” appear in the on-screen display.

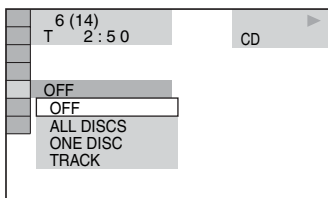

3 Press or repeatedly to select the Repeat Play setting you want.

The default settings are underlined.

■ When playing a DVD VIDEO or DVD-RW in VR mode

- OFF: does not play back repeatedly.
- ALL DISCS: repeats all the titles of all the discs.
- ONE DISC: repeats all the titles on the current disc.
- TITLE: repeats the current title.
- CHAPTER: repeats the current chapter.

■ When playing a VIDEO CD or AUDIO CD

- OFF: does not play back repeatedly.
- ALL DISCS: repeats all the tracks of all the discs.
- ONE DISC: repeats all the tracks on the current disc.
- TRACK: repeats the current track.

■ When playing a DATA CD or DATA DVD

- OFF: does not play back repeatedly.
- ALL DISCS: repeats all the tracks or files of all the discs.
- ONE DISC: repeats all the albums on the current disc.
- ALBUM: repeats the current album.
- TRACK¹⁾: repeats the current track.
- FILE²⁾: repeats the current file.

■ When Program Play or Shuffle Play is On

- OFF: does not play back repeatedly.
- ON: repeats the Program Play or Shuffle Play.

4 Press ENTER.

Repeat Play starts.

If you select the setting other than “OFF”, the  indicator lights up in green.

¹⁾ MP3 audio tracks only.

²⁾ DivX video files only.

To cancel Repeat Play

Press CLEAR or select “OFF” in step 3.

To turn off the Control Menu

Press  DISPLAY repeatedly until the Control Menu disappears from the on-screen display.

Notes

- You can also change the Repeat Play setting by pressing REPEAT repeatedly.
- “REPEAT” lights up in the display when the Repeat Play setting is “ALL DISCS”, “ONE DISC”, “TITLE”, “ALBUM” or “ON”.
- “REPEAT1” lights up in the display when the Repeat Play setting is “CHAPTER”, “TRACK” or “FILE”.
- Depending on the DVD VIDEO, you cannot perform Repeat Play.
- You cannot perform Repeat Play during playback with PBC functions of VIDEO CDs (page 24).
- When playing a DATA CD which contains MP3 audio tracks and JPEG image files, the audio sound will not match the image if their playing time are different.
- You cannot select “TRACK” when “MODE (MP3, JPEG)” is set to “IMAGE (JPEG)”.

Tip

You can also change the Repeat Play setting when the playback is stopped.

Creating your own program

— Program Play



You can make a program of up to 99 steps in the order you want them to be played back. You can only program the tracks from the current disc.

1 Press DISPLAY.

The Control Menu appears in the on-screen display.

2 Press or repeatedly to select (PROGRAM), then press ENTER.

The options for “PROGRAM” appear in the on-screen display.

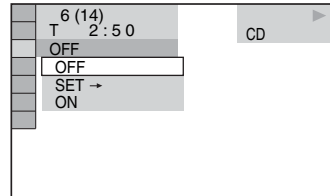

3 Press or repeatedly to select “SET→”, then press ENTER.

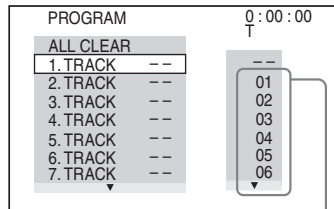

Tracks number

continued

4 Press →.

The cursor moves to the track row “T” (in this case, “01”).

PROGRAM	0:00:00
ALL CLEAR	--
1. TRACK --	01
2. TRACK --	02
3. TRACK --	03
4. TRACK --	04
5. TRACK --	05
6. TRACK --	06
7. TRACK --	--

5 Select the track you want to program.

For example, select track “02”. Press ↑ or ↓ repeatedly to select “02” under “T”, then press ENTER.

Selected track

PROGRAM	0:15:30
ALL CLEAR	--
1. TRACK (02)	01
2. TRACK --	02
3. TRACK --	03
4. TRACK --	04
5. TRACK --	05
6. TRACK --	06
7. TRACK --	--

Total time of the programmed tracks

6 To program other tracks, repeat steps 4 to 5.

7 Press ▷ (or ◀▶ on the unit).

Program Play starts.

If you select setting other than “OFF”, the



indicator lights up in green.

When the Program Play ends, you can restart the same program by pressing ▷ (or ◀▶ on the unit).

To cancel Program Play

Press CLEAR or select “OFF” in step 3. To play back the same program again, select “ON” in step 3 and press ENTER or ▷ (or ◀▶ on the unit).

To change a programmed step

- 1 Follow steps 1 to 3 of “Creating your own program”.
- 2 Select the programmed step number you want to change using ↑ or ↓. Then, press →.
- 3 Follow step 5 of “Creating your own program” to program a new track.

To delete a programmed step from program list

- 1 Follow steps 1 to 3 of “Creating your own program”.
- 2 Select the programmed step number you want to delete by using ↑ or ↓. Then, press CLEAR.
The selected step is deleted. The following steps is shifted up.

To delete all of the programmed steps in the program list

- 1 Follow steps 1 to 3 of “Creating your own program”.
- 2 Press ↑ and select “ALL CLEAR”.
- 3 Press ENTER.

Notes

- The “REPEAT” setting is automatically change to “ON” if the current setting is other than “OFF”.
- You cannot perform Program Play during playback with PBC functions of VIDEO CDs.

Tip

The Program Play is canceled and the program list is cleared when

- the disc tray is opened.
- you press DISC SKIP (or one of the DISC 1 ~ 3 buttons on the unit) to select another disc.
- you turn off the system.
- you unplug the unit.
- you change the function.
- you perform CD Synchro Recording.

Playing DVD VIDEOS using the menu

DVD-V

Some DVD VIDEOS have menus to help you enjoy the DVD VIDEOS. You can play back DVD VIDEOS using these menus on the TV screen.

Using TOP MENU

A DVD VIDEO is divided into long sections of picture or music feature called “title”. When you play back a DVD VIDEO which contains several titles, you can select the title you want using TOP MENU.

Using MENU

Some DVD VIDEOS allow you to select the disc contents using a menu. When you play back these DVD VIDEOS, you can select items such as the language for the subtitles and the language for the sound using MENU.

1 Press TOP MENU or MENU.

The menu appears on the TV screen. The contents of the menu vary depending on the disc.

2 Press ↑ and ↓ or ← and → or the numeric buttons to select the title or item you want to play back.

3 Press ENTER.

Selecting “ORIGINAL” or “PLAY LIST” on a DVD-RW

DVD-RW

You can play back DVD-RWs in VR mode either according to the originally recorded sequence or playlist created on the disc. This function only available for DVD-RWs in VR mode with playlist created.

1 Press DISPLAY when playback is stopped.

The Control Menu appears in the on-screen display.

2 Press ↑ or ↓ repeatedly to select (ORIGINAL/PLAY LIST), then press ENTER.

The options for “ORIGINAL/PLAY LIST” appear in the on-screen display.

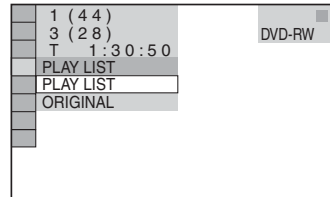

3 Press ↑ or ↓ repeatedly to select a setting you want.

- PLAY LIST: plays back according to the playlist created on the disc.
- ORIGINAL: plays back according to the originally recorded sequence.

4 Press ENTER.

Playing VIDEO CDs with PBC functions (Version 2.0)

— PBC Playback



You can use PBC (Playback Control) menus on your TV screen to enjoy the disc's interactive software. The menu format and structure may differ depending on each disc.

1 Press \triangleright (or $\blacktriangleleft\blacktriangleright$ on the unit) to start playing a VIDEO CD with PBC functions (Version 2.0).

The PBC menu appears on the TV screen.

2 Press the numeric buttons to select the item number you want.

3 Press ENTER.

4 Continue playback according to the instructions on the menus to enjoy interactive playback.

Refer to the operating instructions supplied with the VIDEO CD, as the operation procedure may differ according to the VIDEO CD.

To return to the previous menu

Press \curvearrowright RETURN.

Notes

- Depending on the VIDEO CD, the menu may not appear in step 1.
- Depending on the VIDEO CD, "Press ENTER" in step 3 may appear as "Press \triangleright " in the operating instructions supplied with the disc. In this case, press \triangleright (or $\blacktriangleleft\blacktriangleright$ on the unit).
- PBC Playback is canceled when Shuffle Play, Program Play or Repeat Play is On.

To cancel playback with PBC functions

1 When playback is stopped, press $\blacktriangleleft\blacktriangleleft$ or $\blacktriangleright\blacktriangleright$ (or turn $\blacktriangleleft\blacktriangleright$ on the unit clockwise or counterclockwise) or the numeric buttons to select a track.

2 Press \triangleright (or $\blacktriangleleft\blacktriangleright$ on the unit) or ENTER.

"Play without PBC." appears on the TV screen and playback starts from the selected track. Still images, such as the menu screens, will not be shown.

To return to PBC playback, press \blacksquare twice, then press \triangleright (or $\blacktriangleleft\blacktriangleright$ on the unit).

About MP3 audio tracks and JPEG image files



What is MP3/JPEG?

MP3 is audio compression technology that satisfies the ISO/MPEG regulations. JPEG is image compression technology.

Discs that the system can play back

You can play back DATA CDs (CD-ROMs/CD-Rs/CD-RWs) that contains MP3 audio tracks in MPEG 1 Audio Layer 3 and JPEG image files. However, the discs must be recorded according to ISO 9660 Level 1, Level 2 or Joliet in expansion format for the system to recognize the tracks (or files). You can also play back discs recorded in Multi Session.

Refer to the instructions supplied with the CD-R/CD-RW drives and the recording software (not supplied) for details on the recording format.

About the Multi Session discs

If MP3 audio tracks or JPEG image files are recorded in the first session, the system will also play back MP3 audio tracks or JPEG image files in other sessions. If audio tracks and image files in AUDIO CD format or VIDEO CD format are recorded in the first session, only the first session will be played back.

MP3 audio tracks or JPEG image files that the system can play back

- The system can play back the MP3 audio tracks which have the extension “.MP3”.
 - The system can play back JPEG image files –which have the extension “.JPG” or “.JPEG”. –which conform to the DCF* image file format.
- * “Design rule for Camera File system”: Image standard for digital cameras regulated by Japan Electronics and Information Technology Industries Association (JEITA).

Playback order of MP3 audio tracks or JPEG image files

The playback order of MP3 audio tracks or JPEG image files recorded on a DATA CD is as follows:

■ Structure of disc contents

Tree 1 Tree 2 Tree 3 Tree 4 Tree 5

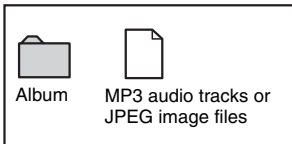
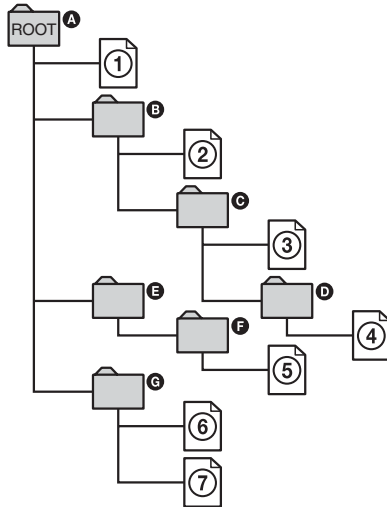

When you insert a DATA CD and press \blacktriangleright (or \blacktriangleleft on the unit), the numbered tracks (or files) are played back sequentially, from ① through ⑦. Any albums or files in current selected album take priority over the next album in the same tree. (Example: C contains D so ④ is played back before ⑤.)

When you press MENU and the list of album names appears (page 28), the album names are arranged in the following order:

A → B → C → D → E → F → G.

Albums that do not contain tracks (or files) (such as album E) do not appear in the list.

Notes

- Depending on the software you use to create the DATA CD, the playback order may differ from the above illustration.
- The playback order above may not be applicable if there are more than 200 albums and 300 files in each album.
- The system can recognize up to 200 albums including albums that do not contain MP3 audio tracks and JPEG image files. The system will not play back any albums beyond the 200th album.
- The maximum number of MP3 audio tracks or JPEG image files on an album which can be recognized by this system is
 - 600 when the “MODE (MP3, JPEG)” is set to “AUDIO (MP3)” or “IMAGE (JPEG)”.
 - 300 when “MODE (MP3, JPEG)” is set to “AUTO”.
- The system may take longer time to play back, when the track or file in another album is played back.
- An album that does not include an MP3 audio track or JPEG image file is skipped.
- The system will play back any data with the extension “.MP3”, “.JPG” or “.JPEG” even if they are not in MP3 or JPEG format. Playing this data may generate a loud noise which could damage your speaker system.
- The system does not support MP3PRO format.
- The system can play back MP3 audio tracks in the format of MPEG 1 Audio Layer 3.
- Depending on the encoding/writing software, recording device, or the recording media used at the time an MP3 audio track is recorded, you may encounter problems such as cannot play back, sound interruptions and noise.
- The following discs take a longer time to start playback:
 - a disc recorded with complicated tree structure.
 - a disc recorded in Multi Session.
 - a disc to which data can be added (non finalized disc).
- Some CD-Rs/CD-RWs/DVD-Rs/DVD-RWs/DVD+Rs/DVD+RWs cannot be played back on the system depending on the file format.

- When playing the DATA CD (CD-ROMs/CD-Rs/CD-RWs) containing both MP3 audio tracks and JPEG image files, select “MODE (MP3, JPEG)” from Control Menu when the TOC reading of the disc is finished. If you want to play back
 - both the MP3 audio tracks and JPEG image files, set “MODE (MP3, JPEG)” to “AUTO”.
 - MP3 audio tracks only, set “MODE(MP3, JPEG)” to “AUDIO (MP3)”.
 - JPEG image files only, set “MODE (MP3, JPEG)” to “IMAGE (JPEG)”.
- The system can playback to a depth of 8 folders only.

Tips

- If you add numbers (01, 02, 03, etc.) to the front of the track or file names when you store the tracks or files in a disc, the tracks and files will be played back in that order.
- Since a disc with many trees takes a longer time to start play back, it is recommended that you create albums with no more than two trees.

Playing DATA CDs with MP3 audio tracks and JPEG image files



MP3 audio tracks and JPEG image files recorded on DATA CDs (CD-ROMs/CD-Rs/CD-RWs) can be played back on this system.

Playing an album of MP3 audio tracks or JPEG image files

1 Load a DATA CD on the disc tray.

The list of albums appears in the on-screen display.



2 Press **↑** or **↓** repeatedly to select the album you want, then press **▷** (or **◀▶** on the unit).

For MP3 audio tracks, the system starts play back from the first track of selected album.

For JPEG image files, the system starts a slide show from the first image file of the selected album.

To stop playback

Press **■**.

To go to the next or previous page of album list

Press **◀** or **▶** repeatedly.

To play back the next or previous MP3 audio track

Press **⏮** or **⏭** repeatedly (or turn **⏮** or **⏭** on the unit clockwise or counterclockwise) during playback.

Note

You can select the next album by pressing **⏭** repeatedly (or turn **⏭** on the unit clockwise) until the last track of the current album, then press **⏭** repeatedly (or turn **⏭** on the unit clockwise). The first track of the next album is selected. However, you cannot select the previous album by pressing **⏮** repeatedly (or turn **⏮** on the unit counterclockwise). To select the previous album, select the album from the album list.

To play back the next or previous JPEG image file

Press **⏮** or **⏭** when the album list is turned off.

Note

You can select the next album by pressing **⏭** repeatedly until the last file of the current album and then press **⏭**. The first file of the next album is selected. However, you cannot select the previous album by pressing **⏮** repeatedly. To select the previous album, select the album from the album list.

To turn on or off the display of album list

Press **MENU** repeatedly.

Note

- You can view the disc information while playing MP3 audio tracks and JPEG image files (page 81).
- You can select Repeat Play while playing MP3 audio tracks and JPEG image files (page 20).
- You can press **AUDIO** to select the audio signal you want while playing an MP3 audio track (page 38).

Playing an MP3 audio track

1 Load a DATA CD with MP3 audio tracks on the disc tray.

The list of the albums appears in the on-screen display. During playback of an album, the album title is shaded.

2 Press **↑** or **↓** repeatedly to select the album you want, then press **ENTER**.

The list of the MP3 audio tracks of the selected album appears in the on-screen display.

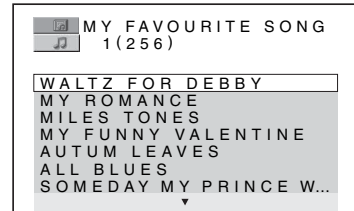

3 Press **↑** or **↓** repeatedly to select the MP3 audio track you want, then press **ENTER**.

The selected MP3 audio track starts playing.

To stop playback

Press **■**.

To go to the next or previous page of tracks list

Press **⏮** or **⏭** repeatedly.

To play back the next or previous MP3 audio track

Press **⏮** or **⏭** repeatedly (or turn **⏮** or **⏭** on the unit clockwise or counterclockwise) during playback.

Note

You can select the next album by pressing **⏭** repeatedly (or turn **⏭** on the unit clockwise) until the last track of the current album, then press **⏭** repeatedly (or turn **⏭** on the unit clockwise). The first track of the next album is selected. However, you cannot select the previous album by pressing **⏮** repeatedly (or turn **⏮** on the unit counterclockwise). To select the previous album, select the album from the album list.

To return to the previous display

Press **↶** RETURN.

To turn on or off the display of album list or track list

Press **MENU** repeatedly.

Playing a JPEG image file

1 Load a DATA CD with JPEG image files on the disc tray.

The list of the albums appears in the on-screen display.

2 Press \uparrow or \downarrow repeatedly to select an album you want, then press PICTURE NAVI.

Thumbnail picture for the first 16 JPEG image files in the selected album is displayed in the on-screen display.

If there are more than 16 image files on the selected album, the scroll bar is shown at the right. Press \downarrow repeatedly until the bottom row of thumbnail picture, and then press \downarrow . The on-screen display will show next 16 image files.

To return to the previous thumbnail picture, press \uparrow repeatedly until the top row of the thumbnail picture. Then, press \uparrow .

1	2	3	4	▶
5	6	7	8	
9	10	11	12	
13	14	15	16	

3 Press $\uparrow/\downarrow/\leftarrow/\rightarrow$ to select the image you want to view, then press \triangleright (or \blacktriangleleft on the unit).

The slide show starts from the selected image file.

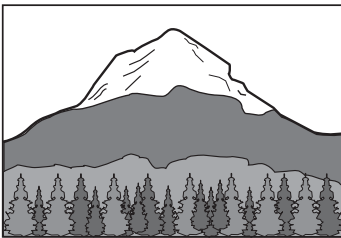

To go to the next or previous JPEG image file

Press \leftarrow or \rightarrow repeatedly when the Control Menu is not displayed.

Note

You can select the next album by pressing \rightarrow repeatedly until the last file of the current album and then press \rightarrow . The first file of the next album is selected. However, you cannot select the previous album by pressing \leftarrow repeatedly. To select the previous album, select the album from the album list.

To rotate an image

When an image is displayed in the on-screen display, you can rotate the image by 90 degrees.

Press \uparrow or \downarrow repeatedly while viewing an image. Each time you press \uparrow , the image rotates counterclockwise by 90 degrees.

Example: When you press \uparrow once

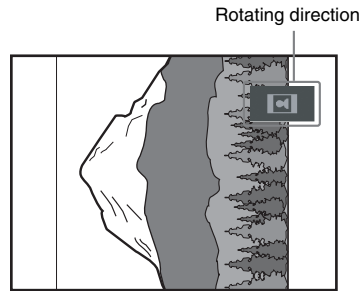

Press CLEAR to return to normal view.

Notes

- This function is canceled when you press \leftarrow or \rightarrow to select next or previous image, the image will return to its original view if it is rotated previously.
- The slide show stops when you press \uparrow or \downarrow .

To stop playback

Press \blacksquare .

Tip

You can also change the slide show speed (page 31) and effect (page 31) while playing JPEG image files.

Playing MP3 audio tracks and JPEG image files as a slide show with sound



You can play back a slide show with sound by first placing both JPEG image files and MP3 audio tracks in the same album on a DATA CD.

1 Load a DATA CD on the disc tray.

The list of albums appears in the on-screen display.

2 Press DISPLAY.

The Control Menu appears in the on-screen display.

3 Press or repeatedly to select (MODE (MP3, JPEG)), then press ENTER.

The options for “MODE (MP3, JPEG)” appear in the on-screen display.

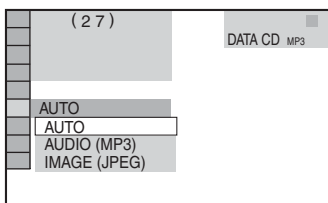

The default setting is underlined.

- AUTO: play back JPEG image files as a slide show with sound (MP3 audio tracks).
- AUDIO (MP3): play back MP3 audio tracks continuously.
- IMAGE (JPEG): play back JPEG image files as a slide show.

4 Press or repeatedly to select “AUTO”, then press ENTER.

5 Press MENU.

The list of album appears in the on-screen display.

6 Press or repeatedly to select the album you want, then press (or on the unit).

The slide show starts from the selected album.

To stop playback

Press .

To turn on or off the display of album list

Press MENU repeatedly

To cancel slide show with sound

Select “AUDIO (MP3)” or “IMAGE (JPEG)” in step 4.

Notes

- There are some cases where you cannot change the “MODE (MP3, JPEG)” setting when
 - the setting of “MODE (MP3, JPEG)” is “IMAGE (JPEG)” and the selected disc only contains MP3 audio tracks.
 - the setting of “MODE (MP3, JPEG)” is “AUDIO (MP3)” and the selected disc only contains JPEG image files.
- You cannot play back JPEG image files and MP3 audio tracks at the same time if they are not contained in the same album.
- When the playback duration of the JPEG image files is longer than the MP3 audio tracks, the image slide show continues without sound.
- When the playback duration of MP3 audio tracks is longer than the JPEG image files, the audio track continues with no slide show.
- If there are no MP3 audio tracks in the DATA CD and the “MODE (JPEG, MP3)” setting is “AUDIO (MP3)”, “No audio data” appears in the on-screen display and the disc cannot be played back.
- If there are no JPEG image files in the DATA CD and the “MODE (JPEG, MP3)” setting is “IMAGE (JPEG)”, “No image data” appears in the on-screen display and the disc cannot be played back.
- The PICTURE NAVI button does not work when “AUDIO (MP3)” is selected.
- If you play back the MP3 audio tracks and the JPEG image files with large data size at the same time, the sound may be skipped. It is recommended that you reduce the data size by creating the MP3 audio tracks with bit rate 128 kbps or lower. If the sound skipping still occurs, reduce the data size of JPEG image file by creating the JPEG image files in smaller size or resolution.

Tips

- You can also change the slide show speed (page 31) and effect (page 31) while viewing JPEG image files.
- If you want to play back a slide show with the same audio track, set the track to Repeat Play (page 20).

Specifying the slide show speed

(JPEG image file only)

When you play back JPEG image files as slide show, you can specify the duration for an image to appear in the on-screen display.

1 Press  **DISPLAY** repeatedly until **Control Menu for JPEG image files** appears in the on-screen display.

2 Press **↑** or **↓** repeatedly to select  (**INTERVAL**), then press **ENTER**.

The options for “INTERVAL” appear in the on-screen display.

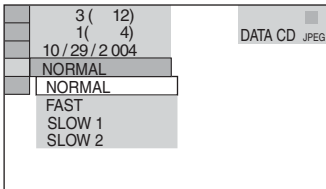

3 Press **↑** or **↓** repeatedly to select the setting you want.

The default setting is underlined.

- NORMAL: Sets the duration to about 6 to 9 seconds (Images that are four million pixels or more will lengthen the duration).
- FAST: Sets the duration shorter than NORMAL.
- SLOW 1: Sets the duration longer than NORMAL.
- SLOW 2: Sets the duration longer than SLOW 1.

4 Press **ENTER**.

The selected setting takes effect.

Note

Some JPEG image files may take longer time to display than others, which may make the duration seems longer than the option you selected. Especially progressive JPEG image files or JPEG image files of 3,000,000 pixels or more.

Selecting a transition effect for image files in the slide show

(JPEG image file only)

When you play back a JPEG image file, you can select the transition effect to be used when viewing the slide show.

1 Press  **DISPLAY** repeatedly until **Control Menu for JPEG image files** appears in the on-screen display.

2 Press **↑** or **↓** repeatedly to select  (**EFFECT**), then press **ENTER**.

The options for “EFFECT” appear in the on-screen display.

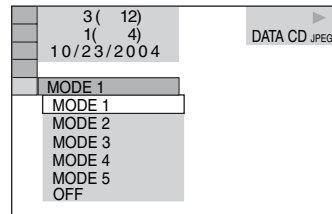

3 Press **↑** or **↓** repeatedly to select the setting you want.

The default setting is underlined.

- MODE 1: The image sweeps in from top to bottom.
- MODE 2: The image of the screen sweeps from left to right of the screen.
- MODE 3: The image stretches out from the center of the screen.
- MODE 4: The image changes with MODE 1, 2, 3 randomly.
- MODE 5: The next image slides over the previous image.
- OFF: Turns off this function.

4 Press **ENTER**.

The selected setting takes effect.

Enjoying DivX® video files



(Except for Latin American models)

About DivX Video Files

DivX® is a video file compression technology, developed by DivXNetworks, Inc. This product is an official DivX® Certified product.

You can play back DATA CDs and DATA DVDs that contain DivX® video files.

DATA CDs and DATA DVDs that the system can play back

Playback of DATA CDs (CD-ROMs/CD-Rs/CD-RWs) and DATA DVDs (DVD-ROMs/DVD-Rs/DVD-RWs/DVD+Rs/DVD+RWs) on this system is subject to certain conditions:

- With DATA CDs that contain DivX video files in addition to MP3 audio tracks or JPEG image files, the system only play back the DivX video files.
- With DATA DVDs, the system only play back DivX video files. DATA DVDs that contains MP3 audio tracks or JPEG image files are not played back.

However, this system only play back DATA CDs that conforms to ISO 9660 Level 1, Level 2 or Joliet in expansion format and DATA DVDs that conforms to Universal Disk Format (UDF). This system can play back DATA CDs in Multi Session but cannot play back DATA DVDs in Multi Session.

Refer to the instructions supplied with the disc driver and the recording software for details on the recording format.

DivX video files that the system can play back

This system can play back files with extension “.AVI” or “.DIVX” that contain data in DivX format.

Notes

- The system may not play back a DivX video file when the file has been combined from two or more DivX video files.
- The system cannot play back a DivX video file which size more than 720 (width) x 576 (height)/2GB.
- Depending on the DivX video file, the picture may be unclear or the sound may skip.
- The system cannot play back some DivX video files that are longer than 3 hours.

Playing an album of DivX video files

1 Load a DATA CD or DATA DVD with DivX video files on the disc tray.

The list of the albums appears in the on-screen display.

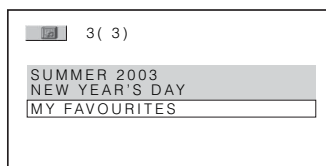

2 Press ↑ or ↓ repeatedly to select the album you want.

3 Press ▷ (or ◀▶ on the unit).

Playback starts from the first DivX video file of the selected album.

To stop playback

Press ■.

To go to the next or previous page of album list

Press → or ← repeatedly.

To turn on or off the display of album list

Press MENU repeatedly.

Playing a DivX video file

1 Load a DATA CD or DATA DVD with DivX video files on the disc tray.

The list of the albums appears in the on-screen display.

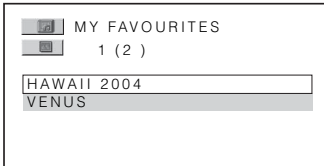

2 Press **↑** or **↓** repeatedly to select the album you want, then press **ENTER**.

The list of files of the selected album appears in the on-screen display.

3 Press **↑** or **↓** repeatedly to select the file you want, then press **ENTER**.

Playback starts from the selected file.

To stop playback

Press **■**.

To go to the next or previous page of file list

Press **→** or **←** repeatedly.

To play back the next or previous DivX video file

Press **⏪** or **⏩** repeatedly (or turn **⏪** or **⏩** on the unit clockwise or counterclockwise) during playback.

Note

You can select the next album by pressing **⏩** repeatedly (or turn **⏪** or **⏩** on the unit clockwise) until the last track of the current album then press **⏩** repeatedly (or turn **⏪** or **⏩** on the unit clockwise). The first track of the next album is selected. However, you cannot select the previous album by pressing **⏪** repeatedly (or turn **⏪** or **⏩** on the unit counterclockwise). To select the previous album, select the album from the album list.

To return to the previous display

Press **↶** RETURN.

Notes

- If there are no DivX video files recorded on a DATA DVD, a message appears to indicate that the disc is not playable.
- Depending on the DivX video file, the picture may pause or unclear. In these case, it is recommended that you create the file at a lower bit rate. If the sound is still noisy, MP3 is the recommended audio format. Note that, this system does not conform to WMA (Windows Media Audio) format.
- Due to the compression technology used for DivX video files, it may take some time after you press **▷** (or **◀▶** on the unit) for the picture to appear.
- Depending on the DivX video file, the sound may not match the pictures on the screen.

Tips

- You can view the disc information while playing a DivX video file (page 81).
- If the number of viewing times is preset, you can play back the DivX video files as many times as the preset number. The following occurrences are counted:
 - when the system is turned off.
 - when the disc tray is opened.
 - when another file is played back.

Searching for a particular point on a disc

— Scan, Slow-motion Play, Freeze Frame



You can quickly locate a particular point on a disc by monitoring the picture or playing back slowly.

Locating a point quickly by playing a disc in fast forward or fast reverse

— Scan

(Except for JPEG image files)

Press ◀◀ or ▶▶ repeatedly (or turn ◀◀▶▶ on the unit clockwise or counterclockwise) while playing a disc. When you find the point you want, press ▷ (or ◀▶ on the unit) to return to normal playback. Each time you press ◀◀ or ▶▶ (or turn ◀◀▶▶ on the unit clockwise or counterclockwise) during scan, the playback speed changes cyclically as follows:

Playback direction

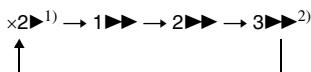

¹⁾ DVD VIDEO and AUDIO CD only

²⁾ DVD VIDEO, DVD-RW in VR mode, DivX video files and VIDEO CD only

Opposite direction

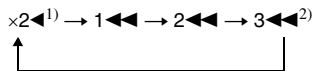

¹⁾ DVD VIDEO only

²⁾ DVD VIDEO, DVD-RW in VR mode, DivX video files and VIDEO CD only

- The “x2▶▶”/“x2◀◀” playback speed is about twice the normal speed.
- The “3▶▶”/“3◀◀” playback speed is faster than the “2▶▶”/“2◀◀”.
- The “2▶▶”/“2◀◀” playback speed is faster than the “1▶▶”/“1◀◀”.

Notes

- Depending on the disc, actual speeds may differ with some discs.
- Depending on the DVD VIDEO and VIDEO CD, you may not be able to do some of the operations.
- For DATA CDs, you can search for a particular point on an MP3 audio track only.

Watching frame by frame

— Slow-motion Play

(DVD VIDEO, DVD-RW in VR mode, DivX video files and VIDEO CD only)

Press SLOW ◀◀ or SLOW ▶▶ repeatedly (or turn ◀◀ SLOW ▶▶ on the unit clockwise or counterclockwise) when the playback is paused. To return to the normal playback, press ▷ (or ◀▶ on the unit).

Each time you press SLOW ◀◀ or SLOW ▶▶ (or turn ◀◀ SLOW ▶▶ on the unit clockwise or counterclockwise), the playback speed changes as follow:

Playback direction

2 ▶▶ ↔ 1 ▶▶

Opposite direction (DVD VIDEO and DVD-RW in VR mode only)

2 ◀◀ ↔ 1 ◀◀

- The “2 ▶▶”/“2 ◀◀” playback speed is slower than “1 ▶▶”/“1 ◀◀”.

Playing one frame at a time

— Freeze Frame

(DVD VIDEO, DVD-RW in VR mode, DivX video files and VIDEO CD only)

Press STEP II▶ to go to the next frame when playback is paused. Press ◀II STEP to go to the preceding frame when playback is paused (DVD VIDEO and DVD-RW in VR mode only). To return to normal playback, press ▷ (or ◀▶ on the unit).

Notes

- You cannot search for a still picture on a DVD-RW in VR mode.
- For DATA CDs, this function available only for DivX video files.

Using the on-screen display to search for a title/chapter/scene/track/index/album/file



You can search a title (DVD VIDEO and DVD-RW in VR mode), chapter (DVD VIDEO and DVD-RW in VR mode), track (AUDIO CD, VIDEO CD and MP3 audio tracks), scene (VIDEO CD), index (VIDEO CD), album (MP3 audio tracks, JPEG image files and DivX video files) and file (JPEG image files and DivX video files). As titles, tracks, albums, chapters, indexes and files are assigned unique numbers on the disc, you can select the number you want from the Control Menu in the on-screen display. You can also search for a particular point using the time code (Time Search) (DVD VIDEO and DVD-RW in VR mode only).

1 Press **DISPLAY**. (When playing a DATA CD with JPEG image files, press **DISPLAY** twice.)

The Control Menu appears in the on-screen display.

2 Press **↑** or **↓** repeatedly to select the search item.

■ When playing a DVD VIDEO or DVD-RW in VR mode

- TITLE
- CHAPTER

■ When playing a VIDEO CD without PBC Playback

- TRACK
- INDEX

■ When playing a VIDEO CD with PBC Playback

- SCENE

■ When playing an AUDIO CD

- TRACK

■ When playing a DATA CD (MP3 audio track)

- ALBUM
- TRACK

■ When playing a DATA CD (JPEG image file)

- ALBUM
- FILE

■ When playing a DATA CD or DATA DVD (DivX video file)

- ALBUM
- FILE

Example: when you select (CHAPTER)

“** (**)” is selected (** refers to a number). The number in parentheses indicates the total number of titles, chapters, tracks, indexes, scenes, albums or files.

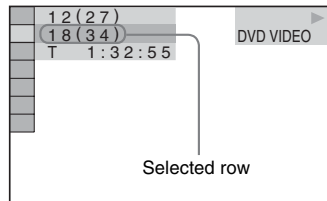

3 Press ENTER.

“** (**)” change to “- - (**)”.

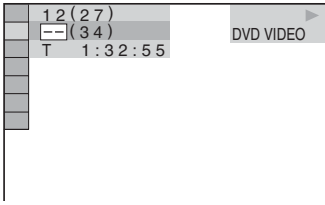

4 Press ↑ or ↓ repeatedly or numeric buttons to select the title, chapter, track, index, scene, etc number you want to search.

If you make a mistake, press CLEAR to cancel the number, then select another number.

5 Press ENTER.

The system starts playback from the selected title, chapter, track, index, scene, album or file.

To turn off the Control Menu

Press  DISPLAY repeatedly until the Control Menu disappears from the on-screen display.

To search for a particular point using the time code

— Time Search



For example, search for the elapsed playing time of the current title of the DVD VIDEO.

1 Press DISPLAY.

The Control Menu appears in the on-screen display.

2 Press ↑ or ↓ repeatedly to select



(TIME/TEXT).

“T **: **: **” (elapsed playing time of the current title) is selected.

3 Press ENTER.

“T **: **: **” change to “T--:--:--”.

4 Input the time code using the numeric buttons, then press ENTER.

For example, to find the scene at 2 hours, 10 minutes, and 20 seconds after the beginning, enter “2:10:20”.

If you make a mistake, press CLEAR to cancel the number, then select another number.

Note

Depending on the DVD VIDEO, you cannot perform Time Search.

Tip

You can change the display to show elapsed playing time or remaining time. For details, see “Checking the elapsed playing time, remaining time and titles” on page 81.

Searching by scene

— Picture Navigation



You can view the first scene of each track (VIDEO CD and Super VCD), each chapter (DVD VIDEO) or each title (DVD VIDEO) and find the track, chapter or title you want quickly.

1 For DVD VIDEO, press PICTURE NAVI repeatedly to select “CHAPTER VIEWER” or “TITLE VIEWER”. For VIDEO CD and Super VCD, press PICTURE NAVI to select “TRACK VIEWER”.

- CHAPTER VIEWER (DVD VIDEO only): displays the first scene of each chapter.
- TITLE VIEWER (DVD VIDEO only): displays the first scene of each title.
- TRACK VIEWER (VIDEO CD and Super VCD only): displays the first scene of each track.

2 Press ENTER.

The first scene of each chapter, title or track appears in the on-screen display as follows:

1	2	3	
4	5	6	
7	8	9	▼

3 Press ↑/↓/←/→ to select a chapter, title or track, then press ENTER.

Playback starts from the selected scene.

To cancel searching

Press ⏪ RETURN or 🖨 DISPLAY.

Notes

- Depending on the disc, you may not be able to select some items.
- “VIEWER” appears in the display during Picture Navigation.

Tip

If there are more than 9 chapters, titles, or tracks, ▼ is displayed at the bottom right of the screen.

To display the remaining chapters, titles, or tracks, select a scene at the bottom row and press ↓. To return to the previous scene, select a scene at the top row and press ↑.

Changing the sound/ subtitle/language



Changing the sound

You can select the audio format you want while playing a DVD VIDEO or DivX video file recorded in multiple audio format. If the DVD VIDEO or DivX video file is recorded in Multilingual tracks, you can also change the language.

You can select the sound from the right or left channel and listen to the sound of the selected channel through both the right and left speakers while playing a VIDEO CD, AUDIO CD or an MP3 audio track. For example, when playing a track with the vocals on the right channel and the instrument on the left channel, you can hear the instruments from both speakers by selecting left channel.

Press AUDIO repeatedly during playback to select the audio signal you want.

The default settings are underlined.

■ When playing a DVD VIDEO

Depending on the DVD VIDEO, the options for language and audio format varies.

When 4-digits number is displayed, it represents the language code (see “Language code list” on page 101). When the same language is displayed twice or more times, the DVD VIDEO is recorded in multiple audio formats.

■ When playing a DVD-RW in VR mode

The number of audio tracks recorded on a disc are displayed.

Example:

- 1: MAIN: The main sound of the audio track 1.
- 1: SUB: The sub sound of the audio track 1.
- 1: MAIN+SUB: The main and sub sound of the audio track 1.
- 2: MAIN: The main sound of the audio track 2.
- 2: SUB: The sub sound of the audio track 2.
- 2: MAIN + SUB: The main and sub sound of the audio track 2.

■ When playing a VIDEO CD, AUDIO CD, or an MP3 audio track

- STEREO: The standard stereo sound.
- 1/L: The sound of the left channel (monaural).
- 2/R: The sound of the right channel (monaural).

■ When playing a DATA CD (DivX video file), or DATA DVD (DivX video file)

The options for audio signal format differ depending on the DivX video files contained on the disc.

■ When playing a Super VCD

- 1: STEREO: The stereo sound of the audio track 1.
- 1: 1/L: The sound of the left channel of the audio track 1 (monaural).
- 1: 2/R: The sound of the right channel of the audio track 1 (monaural).
- 2: STEREO: The stereo sound of the audio track 2.
- 2: 1/L: The sound of the left channel of the audio track 2 (monaural).
- 2: 2/R: The sound of the right channel of the audio track 2 (monaural).

Notes

- For discs not recorded in multiple audio formats, you cannot change the sound.
- During playback of DVD VIDEO, the sound may change automatically.

Displaying the audio information of the disc

(DVD VIDEO and DivX video files only)

When you press AUDIO repeatedly during playback, the audio signal format of the disc are displayed in the on-screen display.

■ When playing a DVD VIDEO

For example, in Dolby Digital format, multiple signals ranging from monaural to 5.1 channel signals can be recorded on a DVD VIDEO. Depending on the DVD VIDEO, the number of recorded channels may differ.

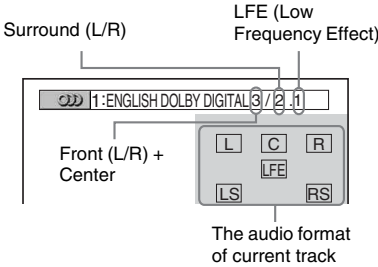

The symbols shown in the on-screen display represents the audio signals channel which is output from the different speaker.

- L: Front Left
- R: Front Right
- C: Center
- LS: Surround Left
- RS: Surround Right
- S: Surround signal which is produced from Dolby Surround Sound or monaural surround of the Dolby Digital.
- LFE: Low Frequency Effect

Example:

For Dolby Digital 5.1 channel:

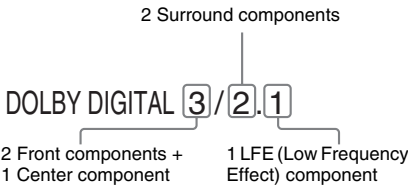

■ When playing a DivX video file

Example:

MP3 audio track

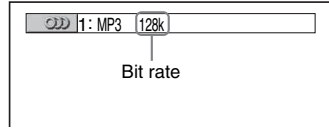

Displaying the subtitles

(DVD VIDEO, DVD-RW in VR mode and DivX video files only)

You can change the language of the subtitles while playing a disc, or turn the subtitles on or off whenever you want with the discs which multilingual subtitles are recorded.

For example you can select the language you want and turn the subtitles on for better understanding.

Press SUBTITLE repeatedly during playback.

Each time you press SUBTITLE, the subtitle language changes.

To turn off the subtitles

Press SUBTITLE repeatedly to select "OFF".

Notes

- Depending on the DVD VIDEO, you may not be able to change the subtitles even if multilingual subtitles are recorded on the DVD VIDEO. You also may not be able to turn them off.
- You can change the subtitles if the DivX video file contains subtitle information within the same file.

Changing the on-screen display language, DVD menu language and audio track auto selection mode

— LANGUAGE SETUP/CUSTOM SETUP

1 Press  **DISPLAY** when playback is stopped.
The Control Menu appears in the on-screen display.

2 Press **↑** or **↓** repeatedly to select  (**SETUP**), then press **ENTER**.
The options for “SETUP” appear in the on-screen display.

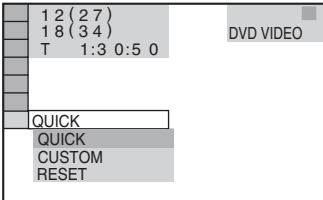

3 Press **↑** or **↓** repeatedly to select “**CUSTOM**”, then press **ENTER**.
The “LANGUAGE SETUP” display appears in the on-screen display.

4 Press **↑** or **↓** repeatedly to select “**LANGUAGE SETUP**” or “**CUSTOM SETUP**”, then press **ENTER**.
When you select “LANGUAGE SETUP”

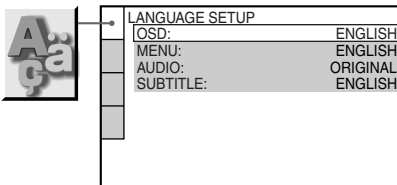

When you select “CUSTOM SETUP”

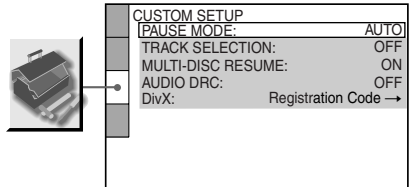

5 Press **↑** or **↓** repeatedly to select an item, then press **ENTER**.
6 Press **↑** or **↓** repeatedly to select a setting, then press **ENTER**.

The default settings are underlined.

■ OSD (on-screen display)

Switches the language of the on-screen display. Select the language from the displayed list.

■ MENU (DVD VIDEO only)

Select the language for the DVD menu.

■ AUDIO (DVD VIDEO only)

Switches the language of the sound track. Select the language from the displayed list. When you select “ORIGINAL”, the language given priority in the disc is selected.

■ SUBTITLE (DVD VIDEO only)

Switches the language of the subtitle. Select the language from the displayed list. When you select “AUDIO FOLLOW”, the language of the subtitles changes according to the language you selected for the sound track.

■ PAUSE MODE (DVD VIDEO and DVD-RW in VR mode only)

Selects the picture in pause mode.

AUTO The picture, including subjects that move dynamically, is output with no jitter. Normally select this position.

FRAME The picture, including subjects that do not move dynamically, is output in high resolution.

■ TRACK SELECTION (DVD VIDEO only)

Gives the priority to the sound track which contains the highest number of channels when you play back a DVD VIDEO on which multiple audio formats (PCM, DTS, or Dolby Digital format) are recorded.

OFF	No priority given.
AUTO	Priority given.

Notes

- When you set to “AUTO”, the language setting may change. The “TRACK SELECTION” setting has higher priority than the “AUDIO” setting in “LANGUAGE SETUP”. Depending on the disc, this function may not work.
- If PCM, MPEG audio, DTS and Dolby Digital sound tracks have the same number of channels, the system selects PCM, DTS, Dolby Digital and MPEG audio sound tracks in this order.

■ MULTI-DISC RESUME (DVD VIDEO and VIDEO CD only)

Turn the Multi-Disc Resume function on or off. Resume playback point can be stored in memory for up to 40 different DVD VIDEO or VIDEO CD discs (page 18).

ON	Stores the resume playback point in memory for up to 40 discs.
OFF	Does not store the resume playback point in memory. Playback starts at the resume playback point only for the current disc in the system.

■ AUDIO DRC (Dynamic Range Compression) (DVD VIDEO and DVD-RW in VR mode only)

Narrows the DYNAMIC range of the sound track. Useful for watching movies at low volume late at night.

OFF	No compression of DYNAMIC range.
STANDARD	Reproduces the sound track with the kind of DYNAMIC range that the recording engineer intended.
MAX	Narrows the DYNAMIC range fully.

Note

AUDIO DRC works only with Dolby Digital source.

■ DivX (Except for Latin American models)

Display the registration code for this system. For more information, go to <http://www.divx.com> on the Internet.

Note

When you select language in “MENU”, “AUDIO” or “SUBTITLE” that is not recorded on the DVD VIDEO, one of the recorded language is automatically selected. Depending on the disc, the language may not be selected automatically.

Tips

- You can reset all the DVD settings except for Parental Control by performing the operations described under “To return the DVD setup to the default settings*, perform reset as follows:” (page 94).
- If you select “OTHERS →” in “MENU”, “AUDIO” or “SUBTITLE”, select and enter the language code from the “Language Code List” (page 101) using the numeric buttons.

Adjusting the angle/image

Changing the angles

DVD-V

You can change the viewing angle while playing a DVD VIDEO on which various angles (multi-angles) for a scene are recorded. For example, while playing a scene of a train in motion, you can display the view from either the front of the train, the left window of the train or the right window of the train without having the train's movement interrupted.

Press ANGLE repeatedly during playback.

Each time you press ANGLE, the angle changes.

Note

Depending on the DVD VIDEO, you may not be able to change the angle even if multi-angles are recorded on the DVD VIDEO.

Adjusting the TV screen

— SCREEN SETUP

1 Press  **DISPLAY** when playback is stopped.

The Control Menu appears in the on-screen display.

2 Press **↑** or **↓** repeatedly to select  (**SETUP**), then press **ENTER**.

The options for "SETUP" appear in the on-screen display.

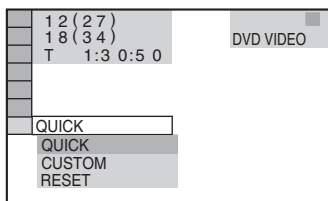

3 Press **↑** or **↓** repeatedly to select "CUSTOM", then press **ENTER**.

The "LANGUAGE SETUP" display appears in the on-screen display.

4 Press **↑** or **↓** repeatedly to select "SCREEN SETUP", then press **ENTER**.

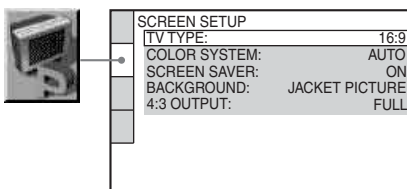

5 Press **↑** or **↓** repeatedly to select an item, then press **ENTER**.

6 Press **↑** or **↓** repeatedly to select a setting, then press **ENTER**.

The default settings are underlined.

■ TV TYPE (DVD VIDEO only)

Select the aspect ratio of the connected TV (4:3 standard or wide).

The default setting varies depending on the area.

16:9 Select this when you connect a wide-screen TV or a TV with a wide mode function.

4:3 LETTER BOX Select this when you connect a 4:3 screen TV. This setting displays a wide picture with bands displayed on the upper and lower portions of the screen.

4:3 PAN SCAN Select this when you connect a 4:3 screen TV. This setting displays a wide picture on the entire screen and cuts off the portions that do not fit.

• 16:9

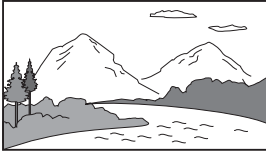

• 4:3 LETTER BOX



• 4:3 PAN SCAN

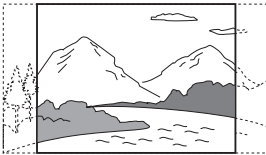

Note

Depending on the DVD VIDEO, “4:3 LETTER BOX” may be selected automatically instead of “4:3 PAN SCAN” or vice versa.

■ COLOR SYSTEM
(Except for Latin American and Russian models)

Select the color system when you play back a VIDEO CD.

<u>AUTO</u>	Output the video signal according to the color system of the disc, either PAL or NTSC.
PAL	Change the video signal of an NTSC disc and output it in the PAL system.
NTSC	Change the video signal of a PAL disc and output it in the NTSC system.

Tip

You can reset all the DVD settings except for parental control by performing the operations described under “To return the DVD setup to the default settings*, perform reset as follows:” (page 94).

■ SCREEN SAVER

Turn on and off the screen saver. If you turn on the screen saver, the screen saver image appears when playback is stopped or paused for 15 minutes or when you play back an AUDIO CD, MP3 audio tracks or JPEG image files (except during slide show) for more than 15 minutes. The screen saver prevents your display device from becoming damaged (ghosting). Press \triangleright (or \blacktriangleleft on the unit) to cancel the screen saver.

<u>ON</u>	Turns on the screen saver.
OFF	Turns off the screen saver.

■ BACKGROUND

Select the background colour or picture to be displayed on the TV screen. The background colour or picture is displayed when the playback is stopped or while playing an AUDIO CD or MP3 audio tracks.

<u>JACKET PICTURE</u>	The jacket picture (still picture) appears in the background, but only when the jacket picture is already recorded on the disc (DVD VIDEO, CD-EXTRA, etc.). If the disc does not contain a jacket picture, the “GRAPHICS” picture appears.
GRAPHICS	The preset picture stored in the system appears in the background.
BLUE	The background color is blue.
BLACK	The background color is black.

■ BLACK LEVEL
(Latin American models only)

Select the black level (setup level) for the video signals output from the video jacks other than COMPONENT VIDEO OUT jacks.

<u>ON</u>	Set the black level of the output signal to the standard level.
OFF	Lower the standard black level. Use this when the picture becomes too white.

■ BLACK LEVEL (COMPONENT OUT)
(Latin American models only)

Select the black level (setup level) for the video signals output from the COMPONENT VIDEO OUT jacks.

You cannot select “BLACK LEVEL (COMPONENT OUT)” when the system outputs progressive signal.

<u>OFF</u>	Set the black level of the output signal to the standard level.
ON	Raise the standard black level. Use this when the picture becomes too black.

■ 4:3 OUTPUT

This setting is effective only when you set “TV TYPE” in “SCREEN SETUP” to “16:9”. Adjust this to watch 4:3 aspect ratio progressive signals. If you can change the aspect ratio on your progressive format (525p/625p) compatible TV, change the setting on your TV. This setting is effective only when “P AUTO” or “P VIDEO” is selected by using the PROGRESSIVE button on the unit.

<u>FULL</u>	Select this when you can change the aspect ratio on your TV.
NORMAL	Select this when you cannot change the aspect ratio on your TV. Shows a 16:9 aspect ratio signal with black bands on left and right sides of the image.

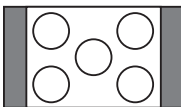

16:9 aspect ratio TV

Adjusting the delay time between the picture and sound

— **A/V SYNC**



When the sound does not synchronize with the pictures on the screen, you can adjust the delay time between the picture and sound.

A/V SYNC does not work for MP3 audio tracks and JPEG image files in DATA CD.

1 Press **DISPLAY** when playback is stopped.

The Control Menu appears in the on-screen display.

2 Press **↑** or **↓** repeatedly to select (A/V SYNC), then press **ENTER**.

The options for “A/V SYNC” appear in the on-screen display.

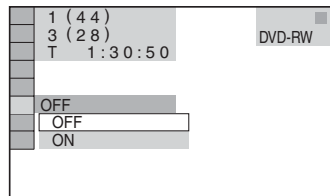

3 Press **↑** or **↓** repeatedly to select the setting you want.

The default setting is underlined.

- OFF: does not adjust.
- ON: adjusts the difference between sound and picture.

4 Press **ENTER**.

Note

Depending on the input stream, this function may not work.

Restricting playback of the disc

— CUSTOM PARENTAL CONTROL/ PARENTAL CONTROL



You can set 2 kinds of playback restrictions for the disc you want.

- Custom Parental Control
You can set playback restrictions so that the system will not play back inappropriate discs.
- Parental Control
Playback of some DVD VIDEOS can be limited according to a predetermined level such as the age of the users. Scenes may be skipped or replaced with different scenes.

The same password is used for both Custom Parental Control and Parental Control.

Preventing playback of specific discs

— CUSTOM PARENTAL CONTROL



You can set the playback restrictions so that the system will not play back inappropriate discs. You can set the same Custom Parental Control password for up to 40 discs. When you set the forty-first disc, the playback restriction for the first disc is canceled.

1 Insert the disc you want to set the playback restriction.

If the disc is playing, press ■ to stop playback.

2 Press DISPLAY when playback is stopped.

The Control Menu appears in the on-screen display.

3 Press or repeatedly to select (PARENTAL CONTROL), then press ENTER.

The options for “PARENTAL CONTROL” appear in the on-screen display.

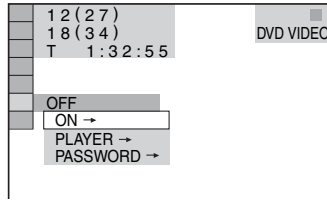

4 Press or repeatedly to select the “ON→”, then press ENTER.

■ If you have not entered a password
The display for registering a new password appears in the on-screen display.

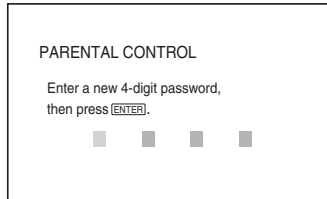

Enter a 4-digit password using the numeric buttons, then press ENTER. The display for confirming the password appears in the on-screen display.

■ When you have already registered a password

The display for entering the password appears in the on-screen display.

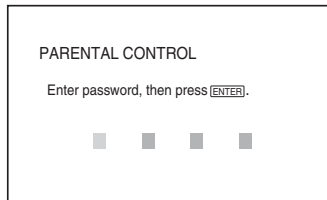

5 Enter or re-enter your 4-digit password using the numeric buttons, then press ENTER.

“Custom parental control is set.” appears in the on-screen display and the screen returns to the Control Menu.

If you make a mistake entering your password

Press ◀ before you press ENTER and input the correct number.

If you make a mistake

Press ⏏ DISPLAY, then start from step 3 again.

To turn off the Control Menu

Press ⏏ DISPLAY repeatedly until the Control Menu disappears from the on-screen display.

To turn off the Custom Parental Control function

- 1** In step 4, select “OFF→”, then press ENTER.
- 2** Enter your 4-digit password using the numeric buttons, then press ENTER.

To change the password

- 1** In step 4, select “PASSWORD→”, then press ENTER.
The display for entering the password appears in the on-screen display.
- 2** Enter your 4-digit password using the numeric buttons, then press ENTER.
- 3** Enter a new 4-digit password using the numeric buttons, then press ENTER.
- 4** To confirm your password, re-enter it using the numeric buttons, then press ENTER.

Playing the disc for which Custom Parental Control is set

1 Insert the disc for which Custom Parental Control is set.

The “CUSTOM PARENTAL CONTROL” display appears in the on-screen display.

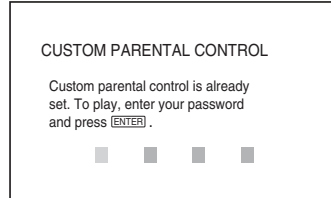

2 Enter your 4-digit password using the numeric buttons, then press ENTER.

The system is ready for playback.

Tip

If you forgot your password, enter the 6-digit number “199703” using the numeric buttons when the “CUSTOM PARENTAL CONTROL” display prompt you for password, then press ENTER. The display will prompt you to enter a new 4-digit password.

Limiting playback for children

— Parental Control



You can limit the playback of some DVD VIDEOS according to a predetermined level such as the age of the users.

1 Press ⏏ DISPLAY when the playback is stopped.

The Control Menu appears in the on-screen display.

- 2** Press **↑** or **↓** repeatedly to select  (PARENTAL CONTROL), then press ENTER.

The options for “PARENTAL CONTROL” appear in the on-screen display.

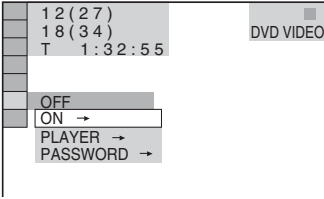

- 3** Press **↑** or **↓** repeatedly to select “PLAYER→”, then press ENTER.

■ **If you have not entered a password**
The display for registering a new password appears in the on-screen display.

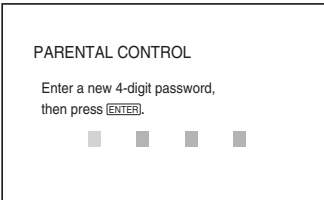

Enter a 4-digit password using the numeric buttons, then press ENTER. The display for confirming the password appears in the on-screen display.

■ **When you have already registered a password**

The display for entering the password appears in the on-screen display.

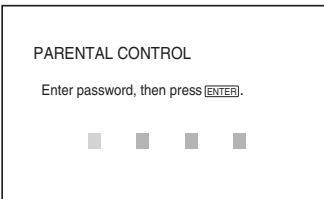

- 4** Enter or re-enter your 4-digit password using the numeric buttons, then press ENTER.

The display for setting the playback limitation level appears in the on-screen display.

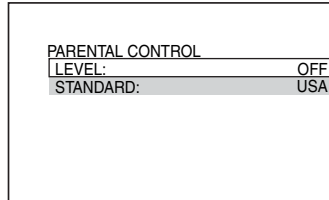

If you make a mistake entering your password

Press **←** before you press ENTER and input the correct number.

- 5** Press **↑** or **↓** repeatedly to select “STANDARD”, then press ENTER.

The options for “STANDARD” appear in the on-screen display.

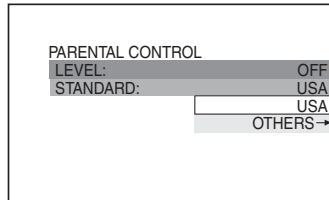

- 6** Press **↑** or **↓** repeatedly to select a geographic area as the playback limitation level, then press ENTER.

The area is selected.

When you select “OTHERS→”, enter the area code in the table on page 49 using the numeric buttons.

- 7** Press **↑** or **↓** repeatedly to select “LEVEL”, then press **ENTER**.

The options for “LEVEL” appear in the on-screen display.

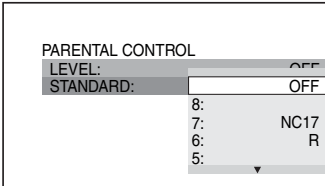

- 8** Press **↑** or **↓** repeatedly to select the level you want, then press **ENTER**.

The Parental Control setting is completed. The lower the value, the more strict the limitation.

If you make a mistake

Press **⏏** DISPLAY, then start from step 2 again.

To turn off the Control Menu

Press **⏏** DISPLAY repeatedly until the Control Menu disappears from the on-screen display.

To turn off the Parental Control function

Set “LEVEL” to “OFF” in step 8.

To change the password

- 1** In step 3, select “PASSWORD →”, then press **ENTER**.

The display for entering the password appears in the on-screen display.

- 2** Enter your 4-digit password using the numeric buttons, then press **ENTER**.
- 3** Enter a new 4-digit password using the numeric buttons, then press **ENTER**.
- 4** To confirm your password, re-enter it using the numeric buttons, then press **ENTER**.

Playing the disc for which Parental Control is set

- 1** Insert the disc and press **▷** (or **◀▶** on the unit).

The display for entering your password appears in the on-screen display.

- 2** Enter your 4-digit password using the numeric buttons, then press **ENTER**.

Playback starts.

Notes

- Depending on the disc type, the Control Menu will show different items.
- When you play back DVD VIDEOS which do not have the Parental Control function, playback cannot be limited on this system.
- Depending on the DVD VIDEO, you may be asked to change the parental control level while playing the disc. In this case, enter your password, then change the level. If the Resume Play is canceled, the level returns to the original level.

Tip

If you forgot your password, remove the disc and repeat steps 1 to 3 of “Limiting playback for children” (page 46). When you are prompted to enter password, enter “199703” using the numeric buttons, then press **ENTER**. The display will prompt you to enter a new 4-digit password. After you enter a new 4-digit password, reload the disc and press **▷** (or **◀▶** on the unit). When the display for entering your password appears in the on-screen display, enter your new password.

Area code

Standard	Code number
Argentina	2044
Australia	2047
Austria	2046
Belgium	2057
Brazil	2070
Canada	2079
Chile	2090
China	2092
Denmark	2115
Finland	2165
France	2174
Germany	2109
India	2248
Indonesia	2238
Italy	2254
Japan	2276
Korea	2304
Malaysia	2363
Mexico	2362
Netherlands	2376
New Zealand	2390
Norway	2379
Pakistan	2427
Philippines	2424
Portugal	2436
Russia	2489
Singapore	2501
Spain	2149
Sweden	2499
Switzerland	2086
Thailand	2528
United Kingdom	2184

Speaker settings

— SPEAKER SETUP



To obtain the best possible surround sound, set the size of the speakers you have connected and their distance from your listening position.

Then, use the test tone to adjust the level of the speakers to the same level.

Setting the speaker size and distance



- 1 Press  **DISPLAY** when playback is stopped.

The Control Menu appears in the on-screen display.

- 2 Press  or  repeatedly to select  (**SETUP**), then press **ENTER**.

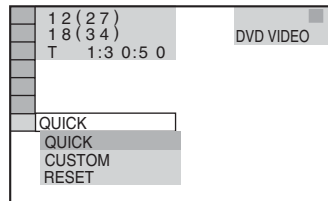
The options for “SETUP” appear in the on-screen display.



- 3 Press  or  repeatedly to select “CUSTOM”, then press **ENTER**.

The “LANGUAGE SETUP” display appears in the on-screen display.

- 4 Press  or  repeatedly to select “SPEAKER SETUP”, then press **ENTER**.

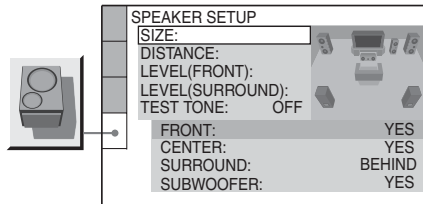

continued

- 5** Press **↑** or **↓** repeatedly to select “**SIZE**” or “**DISTANCE**”, then press **ENTER**.
- 6** Press **↑** or **↓** repeatedly to select the setup item, then press **ENTER**.
- 7** Press **↑** or **↓** repeatedly to select or set a setting, then press **ENTER**.

Note

You cannot perform **SPEAKER SETUP** when you connect headphones or microphones to the unit.

To return to the default setting after you change a setting

Press **CLEAR** before you press **ENTER**. However, you cannot return “**SIZE**” setting to default value.

■ SIZE

When you connect or disconnect center speaker, surround speakers or subwoofer, or you move the surround speakers, adjust the setting for **CENTER**, **SURROUND** and **SUBWOOFER**. Since the front speaker setting is fixed, you cannot change it.

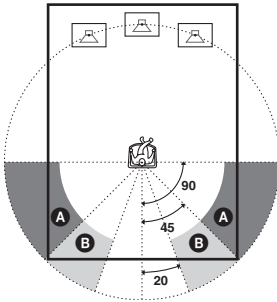

The default settings are underlined.

FRONT	<u>YES</u>
CENTER	<u>YES</u> : Normally select this. NONE: Select this when center speaker is not connected.
SURROUND	<u>BEHIND</u> : Select this if surround speakers are located in section B . SIDE: Select this if surround speakers are located in section A . NONE: Select this when surround speakers are not connected.
SUBWOOFER	<u>YES</u> : Select this when an optional subwoofer is connected. NONE: Select this when an optional subwoofer is not connected.

Notes

- When adjusting speakers setting, the sound may cut off for a moment.
- Depending on the settings of other speakers, the optional subwoofer may output the excessive sound.
- When you play back a DVD VIDEO that does not have subwoofer output recorded, note that no sound is produced from the subwoofer, even if “**SUBWOOFER**” is set to “**YES**”.
- When you connect an optional subwoofer, make sure you have set the “**SUBWOOFER**” to “**YES**”. If set to “**NONE**”, no sound is output from the optional subwoofer.

■ DISTANCE

The default setting for the speakers distance in relation to the listening position is shown below.

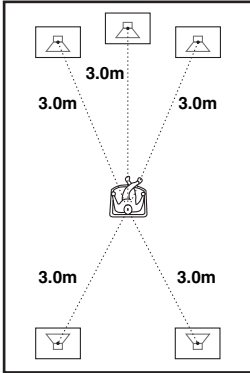

Be sure to change the value in the Control Menu when you move the speakers. When you set the distance using the QUICK SETUP (page 14), the settings are automatically displayed. Any items that are set to “NONE” in the “SIZE” setting cannot be selected.

The default settings are underlined.

FRONT <u>3.0m</u> ¹⁾	Front speaker distance from the listening position can be set in 0.2 meter increments from 1.0 to 7.0 meters.
CENTER <u>3.0m</u> ¹⁾²⁾	Center speaker distance from the listening position can be set in 0.2 meter increments from 0.0 to 7.0 meters.
SURROUND <u>3.0m</u> ¹⁾²⁾	Surround speaker distance from the listening position can be set in 0.2 meter increments from 0.0 to 7.0 meters.



¹⁾ The default settings change when you perform QUICK SETUP (page 14).

²⁾ The setting range changes depending on the front speakers setting.

Notes

- When adjusting speakers distance, the sound may cut off for a moment.
- If each of the front or surround speakers are not placed at an equal distance from your listening position, set the distance of the closest speaker.
- Do not place the surround speakers farther away from your listening position than the front speakers.
- Depending on the input stream, the “DISTANCE” setting may not be effective.

Adjusting the speaker volume and level

- 1** Press  **DISPLAY** when playback is stopped.
The Control Menu appears in the on-screen display in the on-screen display.
- 2** Press **↑** or **↓** repeatedly to select  (**SETUP**), then press **ENTER**.
The options for “SETUP” appear in the on-screen display.
- 3** Press **↑** or **↓** repeatedly to select “**CUSTOM**”, then press **ENTER**.
The “LANGUAGE SETUP” display appears in the on-screen display.
- 4** Press **↑** or **↓** repeatedly to select “**SPEAKER SETUP**”, then press **ENTER**.

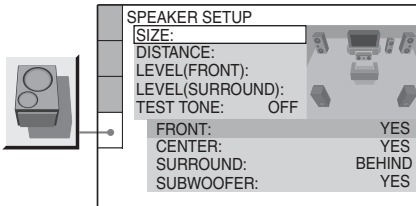

- 5** Press **↑** or **↓** repeatedly to select “**TEST TONE**”, then press **ENTER**.
- 6** Press **↑** or **↓** repeatedly to select “**ON**”, then press **ENTER**.
You will hear the test tone from each speaker in sequence except for subwoofer.
- 7** Press **↑** or **↓** repeatedly to select “**LEVEL (FRONT)**”, then press **ENTER**.
- 8** Press **↑** or **↓** repeatedly to select the speaker, then press **ENTER**.

The test tone is emitted from the selected speaker.

- 9** Press **↑** or **↓** repeatedly to adjust the level from your listening position.
- 10** Press **ENTER** when you finish adjusting.
- 11** Repeat step 8 to 10 to adjust the speaker level for other speakers.
- 12** Press **←**.
- 13** Repeat step 7 to 12 to adjust “**LEVEL (SURROUND)**” setting.
- 14** Press **↑** or **↓** repeatedly to select “**TEST TONE**”, then press **ENTER**.
- 15** Press **↑** or **↓** repeatedly to select “**OFF**”, then press **ENTER**.

Note

When you adjust the speaker settings, the sound cut off for a moment.

Tips

- To adjust the speaker level without listening to the test tone, skip step 5, 6, 14 and 15.
- To change the volume of all speakers at one time, press **VOLUME +/-** repeatedly (or turn **MASTER VOLUME** on the unit clockwise or counterclockwise).

■ LEVEL (FRONT)

You can adjust the level of each front and center speaker and subwoofer as follows. Be sure to set “TEST TONE” to “ON” for easy adjustment.

Any items that are set to “NONE” in “SIZE” setting cannot be selected.

The default settings are underlined.

L	Set this between -6 dB and 0 dB
<u>0.0 dB</u>	in 1 dB increments.
R	Set this between -6 dB and 0 dB
<u>0.0 dB</u>	in 1 dB increments.
CENTER	Set this between -6 dB and +6 dB
<u>0.0 dB</u>	in 1 dB increments.
SUBWOOFER	Set this between -10 dB and +10
<u>0.0 dB</u>	dB in 1 dB increments.

Note

Depending on the subwoofer, the sound output during test tone is turned on may be smaller compared to other speakers.

■ LEVEL (SURROUND)

You can adjust the level of each surround speaker as follows. Be sure to set “TEST TONE” to “ON” for easy adjustment.

This setting cannot be selected if you set “SURROUND” in “SIZE” to “NONE”.

The default settings are underlined.

L	Set this between –6 dB and +6 dB in 1 dB increments.
<u>0.0 dB</u>	
R	Set this between –6 dB and +6 dB in 1 dB increments.
<u>0.0 dB</u>	

■ TEST TONE

The speakers will emit a test tone to adjust “LEVEL (FRONT)” and “LEVEL (SURROUND)”.

The default setting is underlined.

<u>OFF</u>	The test tone is not emitted from the speakers.
ON	The test tone is emitted from each speaker in sequence except for subwoofer. The test tone is emitted from selected speakers during “LEVEL (FRONT)” or “LEVEL (SURROUND)” adjustment.

Using the THEATRE SYNC function

THEATRE SYNC allows you to turn on your Sony TV and this system, changes the system’s function to “DVD” and then switches the TV’s input source you set with one button.

Preparing for the THEATRE SYNC function

Register the TV’s input source connected to this system.

Hold down SLEEP and press numeric buttons, CLEAR or ALBUM +/- to select the TV’s input source connected to this system.

Hold down SLEEP and press	TV’s input source
0	No input source (Default)
1	VIDEO 1
2	VIDEO 2
3	VIDEO 3
4	VIDEO 4
5	VIDEO 5
6	VIDEO 6
7	VIDEO 7
8	VIDEO 8
9	COMPONENT 1
CLEAR	COMPONENT 2
ALBUM –	COMPONENT 3
ALBUM +	COMPONENT 4

The selected TV’s input source is memorized into the remote.

Operating for the THEATER SYNC function

Point the remote to the direction of TV and this unit, then press THEATER SYNC.

If this function does not work, change the transmission time. The transmission time varies depending on the TV.

To change the transmission time

Hold down ►►I and press numeric button to change the transmission time.

Hold down ►►I and press	Transmission time
1	0.5 (Default)
2	1
3	1.5
4	2
5	2.5
6	3
7	3.5
8	4

The transmission time from the remote is selected.

Notes

- This function is only available for Sony TV series.
- If distance between TV and this unit is too far, this function may not work. Install the unit near the TV.

Changing the format of the video signal from COMPONENT VIDEO OUT jacks

Progressive is the method for displaying the TV images which reduces flickering and sharpens the image. To display by using this method, you need to connect to a TV that can accept progressive signals.

You can output video signal from COMPONENT VIDEO OUT jacks in INTERLACE or PROGRESSIVE format.

1 Press FUNCTION +/- repeatedly to select "DVD" (or press DVD on the unit).

2 Press PROGRESSIVE on the unit repeatedly.

Each time you press the button, the display changes cyclically as follows:

P AUTO → P VIDEO → INTERLACE

■ P AUTO (PROGRESSIVE AUTO)

Select this when your TV accepts progressive signals and the TV is connected to the COMPONENT VIDEO OUT jacks. The system automatically detects the software type and selects the appropriate conversion method.

■ P VIDEO (PROGRESSIVE VIDEO)

Select this when your TV accepts progressive signals and the TV is connected to the COMPONENT VIDEO OUT jacks.

The system fix the conversion method to PROGRESSIVE VIDEO for video-based software.

Select this if the image is not clear when you select "P AUTO".

■ INTERLACE

Select this when your TV does not accept progressive signals or your TV is connected to the VIDEO OUT or S VIDEO OUT jack.

About DVD VIDEO software types and the conversion method

The software of DVD VIDEO can be divided into 2 types:

- Film-based software
Film-based software is derived from the film and displays the images at 24 frames per second.
- Video-based software
Video-based software is derived from TV, such as dramas and sitcoms and displays images at 30 frames or 60 fields per second.













Some DVD VIDEO contains both type of software. In order for these images appear in your TV naturally during the video output in progressive format, the progressive signals needs to be converted to match the software type of your DVD VIDEO.









Notes

- When you play back video-based software in progressive signal format, sections of some types of images may appear unnatural due to the conversion process when you connect your TV to the COMPONENT VIDEO OUT jacks.
- The image from VIDEO OUT and S VIDEO OUT jacks are always output in INTERLACE format although you select “P AUTO” or “P VIDEO”.
- There would be no images on your TV or the image is not clear if your setting is not matched with your TV or connection.
- “PROGRESSIVE” lights up in the display when you select “P AUTO” or “P VIDEO”.

List of items that can be displayed and selected by disc type

When you press  DISPLAY, the following items are displayed in Control Menu.

	Control Menu Items	Function
	TITLE (DVD VIDEO and DVD-RW in VR mode only) SCENE (VIDEO CD with PBC playback only) TRACK (VIDEO CD without PBC playback only)	Selects the title (DVD VIDEO/DVD-RW in VR mode) to be played back. Display the scene (VIDEO CD with PBC playback). Selects the track (VIDEO CD without PBC playback) to be played back.
	CHAPTER (DVD VIDEO and DVD-RW in VR mode only) INDEX (VIDEO CD without PBC playback only)	Selects the chapter (DVD VIDEO/DVD-RW in VR mode) to be played back. Selects the index (VIDEO CD without PBC playback) to be played back.
	ALBUM (MP3 audio tracks, JPEG image files and DivX video files only)	Selects the album to be played back.
	TRACK (AUDIO CD and MP3 audio tracks only)	Selects the track to be played back.
	TIME/TEXT	Checks the elapsed playing time and the remaining time. Input the time code for picture and music searching (DVD VIDEO/DVD-RW in VR mode).
	FILE (JPEG image files and DivX video files only)	Selects the file to be played back.
	DATE (JPEG image files only)	Displays the date information.
	REPEAT	Plays the entire disc (all titles/all tracks/all files), one title/chapter/track/album or contents of program repeatedly.
	PARENTAL CONTROL (DVD VIDEO, VIDEO CD and AUDIO CD only)	Sets the disc to prohibit playback.
	A/V SYNC (DVD VIDEO, DVD-RW in VR mode, VIDEO CD and DivX video files only)	Sets the delay time between the sound and picture.
	SETUP	QUICK Choose the language of an on-screen display, the aspect ratio of the TV and the distance of the connected speakers. CUSTOM In addition to the "QUICK" setting, you can adjust other settings. RESET Returns the settings in "CUSTOM" to the default setting.
	KEY CONTROL*	Changes the key to suit your vocal range.
	KARAOKE PON*	Enjoys karaoke with a stereo-recorded disc, by reducing the sound of the vocals.

Control Menu Items	Function
 PROGRAM (AUDIO CD and VIDEO CD only)	Selects the track to play back in the order you want.
 SHUFFLE (AUDIO CD and VIDEO CD only)	Plays back the track in random order.
 VOCAL* (DVD VIDEO, AUDIO CD and VIDEO CD only)	Turns the guide vocal on or off for Dolby Digital Karaoke format disc (DVD VIDEO). Listen to the vocals (VIDEO CD/AUDIO CD).
 VOCAL SELECT* (DVD VIDEO, AUDIO CD and VIDEO CD only)	Changes the vocal type.
 MODE (MP3, JPEG) (MP3 audio tracks and JPEG image files only)	Selects the data to be played back: MP3 audio track (AUDIO), JPEG image file (IMAGE) or both (AUTO).
 INTERVAL (JPEG image files only)	Sets the interval time of image during slide show.
 EFFECT (JPEG image files only)	Selects the transition effect to be used during slide show.
 GUIDE MELODY* (DVD VIDEO only)	Turns the Guide Melody On/Off in the Dolby Digital Karaoke format disc.
 ORIGINAL/PLAY LIST (DVD-RW in VR mode only)	Selects the type of title to be played back.

* This function only available during karaoke mode.

Tips

- Each time you press  DISPLAY, the Control Menu display changes cyclically as follows:

Control Menu display 1



Control Menu display 2*



Control Menu display off

* Control menu display 2 is not available when the selected disc is DATA CD or DATA DVD with DivX video files.

- The Control Menu items different depending on the disc.
- The following icons indicator light up in green when you select any item except “OFF”.
 - REPEAT
 - A/V SYNC
 - KARAOKE PON
 - PROGRAM
 - SHUFFLE
 - VOCAL
 - GUIDE MELODY
- The “ORIGINAL/PLAY LIST” icon indicator lights up in green when you select “PLAY LIST”.

System setup item list

You can set the following items in the following menus.

The default settings are underlined.

LANGUAGE SETUP (page 40)

OSD	Select the language you want to use from the displayed language list.
MENU	Select the language you want to use from the displayed language list.
AUDIO	Select the language you want to use from the displayed language list.
SUBTITLE	Select the language you want to use from the displayed language list.

SCREEN SETUP (page 42)

TV TYPE ¹⁾	<u>16:9</u> 4:3 LETTER BOX 4:3 PAN SCAN
COLOR SYSTEM ²⁾	<u>AUTO</u> PAL NTSC
SCREEN SAVER	<u>ON</u> OFF
BACKGROUND	<u>JACKET PICTURE</u> GRAPHICS BLUE BLACK
BLACK LEVEL ³⁾	<u>ON</u> OFF
BLACK LEVEL (COMPONENT OUT) ³⁾	<u>OFF</u> ON
4:3 OUTPUT	<u>FULL</u> NORMAL

CUSTOM SETUP (page 40)

PAUSE MODE	<u>AUTO</u> FRAME
TRACK SELECTION	<u>OFF</u> AUTO
MULTI-DISC RESUME	<u>ON</u> OFF
AUDIO DRC	<u>OFF</u> STANDARD MAX
DivX ⁴⁾	Registration Code →

SPEAKER SETUP (page 49)

SIZE	FRONT	<u>YES</u>
	CENTER	<u>YES</u> NONE
	SURROUND	<u>BEHIND</u> SIDE NONE
	SUBWOOFER	<u>YES</u> NONE
DISTANCE	FRONT	<u>3.0m</u> (1.0 m - 7.0 m)
	CENTER	<u>3.0m</u> (0.0 m - 7.0 m)
	SURROUND	<u>3.0m</u> (0.0 m - 7.0 m)
LEVEL (FRONT)	L	<u>0.0 dB</u> (-6 dB - 0 dB)
	R	<u>0.0 dB</u> (-6 dB - 0 dB)
	CENTER	<u>0.0 dB</u> (-6 dB - +6 dB)
	SUBWOOFER	<u>0.0 dB</u> (-10 dB - +10 dB)
LEVEL (SURROUND)	L	<u>0.0 dB</u> (-6 dB - +6 dB)
	R	<u>0.0 dB</u> (-6 dB - +6 dB)
TEST TONE	<u>OFF</u> ON	

¹⁾ The default setting varies depending on the area.

²⁾ Except for Latin American and Russian models.

³⁾ Latin American models only.

⁴⁾ Except for Latin American models.

Presetting radio stations

You can preset up to 20 FM stations and 10 AM stations. You can then tune in any of those stations simply by selecting the corresponding preset number.

Automatic tuning preset

You can automatically tune in all of the stations that can be received in your area and then store the frequency of your favourite stations manually.

- 1** Press **FUNCTION +/-** repeatedly to select **"TUNER FM"** or **"TUNER AM"** (or press **TUNER/BAND** on the unit repeatedly to select **"FM"** or **"AM"**).
- 2** Press and hold **TUNING +/-** (or turn and hold **TUNING +/-** on the unit clockwise or counterclockwise) until the frequency indication starts to change and then release.

"AUTO" lights up in the display. Scanning stops automatically when a station is tuned in and "TUNED" lights up in the display. When a FM stereo program is tuned in, "STEREO" lights up in the display.

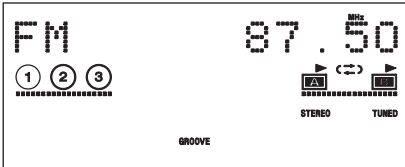

If "TUNED" does not lights up and the scanning does not stop

Set the frequency of the radio station you want as described in step 2 of "Manual tuning preset".

- 3** Press **MENU**.

"Memory?" flashes in the display.

- 4** Press **ENTER**.

A preset number flashes in the display. The stations are stored from preset number 1.

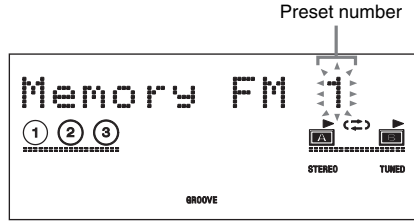

- 5** Press **PRESET +/-** repeatedly (or turn **PRESET +/-** on the unit clockwise or counterclockwise) to select the preset number you want.

- 6** Press **ENTER**.

"Complete!" appears in the display. The station is stored.

- 7** Repeat steps 2 to 6 to store other stations.

Manual tuning preset

You can manually tune in and store the frequency of your favourite stations.

- 1** Press **FUNCTION +/-** repeatedly to select **"TUNER FM"** or **"TUNER AM"** (or press **TUNER/BAND** on the unit repeatedly to select **"FM"** or **"AM"**).
- 2** Press **TUNING +/-** repeatedly (or turn **TUNING +/-** on the unit clockwise or counterclockwise) to tune in the station you want.

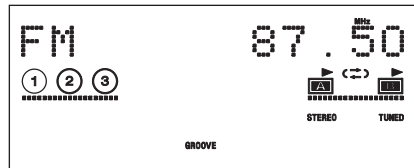

- 3** Press **MENU**.

"Memory?" flashes in the display.

4 Press ENTER.

A preset number flashes in the display.
The stations are stored from preset number 1.

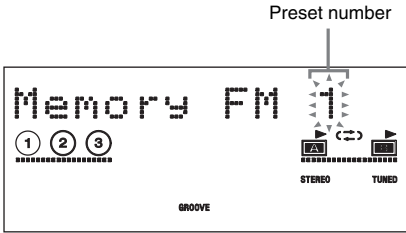

5 Press PRESET +/- repeatedly (or turn PRESET +/- on the unit clockwise or counterclockwise) to select the preset number you want.

6 Press ENTER.

“Complete!” appears in the display. The station is stored.

7 Repeat steps 2 to 6 to store other stations.

Other operations

To	Do this
Tune in a station with a weak signal	Follow the procedure described in “Manual tuning preset” (page 59).
Stop scanning during automatic tuning	Press ■.
Cancel presetting	Press MENU.

To change the AM tuning interval (except for Saudi Arabian and Russian models)

The factory setting for AM tuning interval is 9 kHz (or 10 kHz for some areas).

Use buttons on the unit for the operation.

1 Press TUNER/BAND repeatedly to select “AM”.

2 Press I/⏻ to turn off the system.

3 Hold down ENTER and then press I/⏻ to turn on the system.

“AM 9k STEP” or “AM 10k STEP” appears in the display.

When you change the interval, all the AM preset stations are erased. To reset the interval, repeat the same procedure.

Note

You cannot change the AM tuning interval in the Power Saving Mode (page 79).

Tips

- The preset stations are retained for half a day even if you unplug the power cord or if a power failure occurs.
- If you press TUNER/BAND on the unit while the system is turned off, the system turns on automatically and “TUNER” is selected as the function (except for Power Saving mode (page 79)).

Listening to the radio

You can listen to a radio station either by selecting a preset station, or by manually tuning in the station.

Listening to a preset radio station

— Preset Tuning

Before tuning to preset stations, be sure to preset them first (see “Presetting radio stations” on page 59).

- 1** Press **FUNCTION +/-** repeatedly to select “**TUNER FM**” or “**TUNER AM**” (or press **TUNER/BAND** on the unit repeatedly to select “**FM**” or “**AM**”).
- 2** Press **PRESET +/-** repeatedly (or turn **PRESET +/-** on the unit clockwise or counterclockwise) to select the preset station you want.

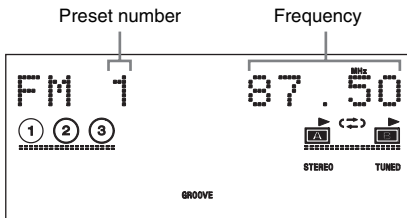

Listening to a non-preset radio station

— Manual Tuning

- 1** Press **FUNCTION +/-** repeatedly to select “**TUNER FM**” or “**TUNER AM**” (or press **TUNER/BAND** on the unit repeatedly to select “**FM**” or “**AM**”).
- 2** Press **TUNING +/-** repeatedly (or turn **TUNING +/-** on the unit clockwise or counterclockwise) to tune in the station you want.

Tips

- When an FM stereo program has static noise, press **FM MODE** repeatedly until “**MONO**” lights up in the display. There will be no stereo effect, but the reception will improve.
- To record the radio programs, see “Recording on a tape manually” (page 64) or “Timer recording radio programs” (page 78).
- To improve broadcast reception, adjust the supplied antennas, or connect an external antenna.
- For Preset Tuning, you can use the numeric buttons to select a preset station. Press numeric button(s) to enter the preset number and then press **ENTER**.

Tape – Playback

Loading a tape

- 1 Push **▶ (A)** or **◀ (B)** on the unit according to its direction to open the selected deck.

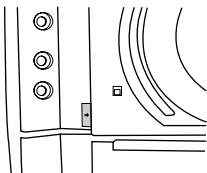

- 2 Load a tape into Deck A or B.

With the side you want to play back or record facing forward

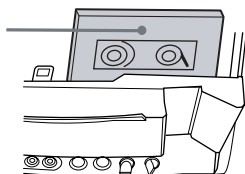

- 3 Push the center of the tape lid to close the deck.

Playing a tape

You can use TYPE I (normal) tape.

- 1 Load a tape.
- 2 Press **FUNCTION +/-** (or **TAPE A/B** on the unit) repeatedly to select “**TAPE A**” or “**TAPE B**”.
- 3 Press **DIRECTION** on the unit repeatedly to select “**▶▶**” to play back one side, “**◀▶**”¹⁾ to play back both sides or “**RELAY**”²⁾ (Relay Play) to play back both decks in succession.
- 4 Press **▷** (or **◀▶** on the unit).

The tape starts playing.

Press **▷** (or **◀▶** on the unit) again to play back the reverse side.

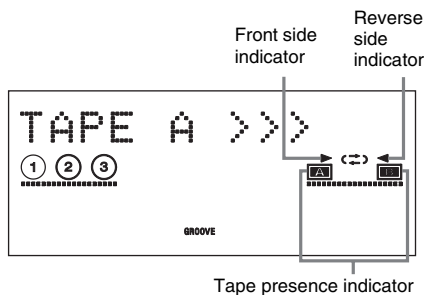

- 1) The playback stops automatically after repeating the sequence five times.
- 2) Relay Play follows this cyclic sequence up to five times, then stops:
Deck A (front side) → Deck A (reverse side)
→ Deck B (front side) → Deck B (reverse side)

Other operations

To	Do this
Stop playback	Press ■.
Pause playback	Press II. Press II again to resume playback.
Fast-forward or rewind	Press ◀◀ or ▶▶ (or turn ◀▶▶ on the unit clockwise or counterclockwise). To return to normal playback, press ▷ (or ◀▶ on the unit).
Remove a tape	Push ▶ (▶ A) or ◀ (B ▶) on the unit according to its direction when playback is stopped.

Note

Do not push ▶ (▶ A) or ◀ (B ▶) on the unit while playing a tape, otherwise the tape could be damaged.

Tips

- When a tape is inserted, corresponding presence indicator lights up in the display.
- If you press TAPE A/B on the unit while the system is turned off, the system turns on automatically and “TAPE A” or “TAPE B” is selected as the function.
- If you press ▷ (or ◀▶ on the unit) during TAPE A function and there is no tape in Deck A, the system automatically switches to TAPE B function when there is a tape in Deck B and vice versa. Then, playback will start.

Tape – Recording

Recording your favorite tracks on a disc into a tape

— CD Synchro Recording



You can record a whole disc into a tape. You can use TYPE I (normal) tape. The recording level is adjusted automatically.

Use buttons on the unit for the operation.

- 1 Load a recordable tape into Deck B.**
- 2 Press DVD and load a disc you want to record.**
- 3 Press CD SYNC.**
“SYNC” lights up in the display and “REC” flashes in the display.
Deck B standby for recording.
- 4 Press DIRECTION repeatedly to select “⇌” to record on one side or “↔” (or “RELAY”) to record on both sides.**
- 5 Press REC PAUSE/START.**
“REC” lights up in the display.
Recording starts.

To stop recording

Press ■.

Notes

- You cannot listen to other sources while recording.
- When you press CD SYNC, the sound field is changed to LINK if the current sound field is SBS MULTI, A.F.D. AUTO, PRO LOGIC, PLII MOVIE, PLII MUSIC or V.M.DIM.
- When you press CD SYNC, the sound field is changed to HP 2CH if the current sound field is HP VIRTUAL.
- CD Synchro Recording stops when the current disc finishes playback.
- The CD Synchro Recording function cannot perform under the following circumstances:
 - During playback of the disc.
 - During Custom Parental Control function, when the display for entering the password appears in the on-screen display.
 - Before the system finishes reading the TOC of the disc.
- Program Play or Shuffle Play is canceled when you start CD Synchro Recording.
- The setting for “REPEAT” is changed to “OFF” when you start CD Synchro Recording.
- When you record from a VIDEO CD, playback with PBC function is automatically canceled.
- If you connect or disconnect a microphone or headphone during recording, the sound cuts off for a moment.

Tips

- For recording from the reverse side:
After step 1 of “Recording your favorite tracks on a disc into a tape” (page 63), press TAPE A/B repeatedly until “TAPE B” appears in the display. Press ◀▶ repeatedly until TAPE B reverse side indicator lights up to start playback of the reverse side. Press ■ at the point you want to start recording.
- When you record on both sides, be sure to start from the front side. If you start from the reverse side, recording stops at the end of the reverse side.

Recording on a tape manually

— Manual Recording

You can record just the portions you like from a disc, tape or radio program into a tape.

You can also record from connected components (see “Hooking up optional components” on page 85).

Use buttons on the unit for the operation.

- 1 Load a recordable tape into Deck B.**
- 2 Press DVD, TUNER/BAND, TAPE A/B, TV/SAT or VIDEO to select the source you want to record.**
- 3 Load the disc, tape or tune to the station you want to record. To record from the connected component, connect the external audio sources.**
- 4 Press REC PAUSE/START.**
“REC” flashes in the display.
Deck B standby for recording.
- 5 Press DIRECTION repeatedly to select “←→” to record on one side or “↔” (or “RELAY”) to record on both sides.**
- 6 Press REC PAUSE/START.**
“REC” lights up in the display.
Recording starts.
- 7 Start playing the source to be recorded.**

To stop recording

Press ■.

Notes

- When you press REC PAUSE/START, the sound field is changed to LINK if the current sound field is SBS MULTI, A.F.D. AUTO, PRO LOGIC, PLII MOVIE, PLII MUSIC or V.M.DIM.
- When you press REC PAUSE/START, the sound field is changed to HP 2CH if the current sound field is HP VIRTUAL.
- You cannot listen to other sources while recording.

Tips

- For recording from the reverse side:
After step 1 of “Recording on a tape manually” (page 64), press TAPE A/B repeatedly until “TAPE B” appears in the display. Press ◀▶ repeatedly until TAPE B reverse side indicator lights up to start playback of the reverse side. Press ■ at the point you want to start recording.
- When you record on both sides, be sure to start from the front side. If you start from the reverse side, recording stops at the end of the reverse side.
- For recording from the radio:
If noise is heard while recording from the radio, move the respective antenna to reduce the noise.
- For recording from a disc to a tape manually:
You can turn ◀▶▶▶ clockwise or counterclockwise to select tracks during recording pause mode (after step 4 and before step 6 of “Recording on a tape manually” on page 64).
- For recording from the tape:
If you set the direction to “↔” (or “RELAY”) when the tapes you use have different lengths, the tape in each deck reverses independently.

Sound Adjustment

Adjusting the sound

You can reinforce the bass and create a more powerful sound.

The GROOVE setting is ideal for music sources, and the V-GROOVE setting is ideal for video sources (movie, etc.).

Press GROOVE on the unit repeatedly.

Each time you press the button, the display changes cyclically as follows:

GROOVE ON* → V-GROOVE ON* → GROOVE OFF

* The volume switches to power mode and the equalizer curve changes.

Tips

- The default setting is “GROOVE ON”.
- “GROOVE” lights up in the display if “GROOVE ON” is selected.
- “V-GROOVE” lights up in the display if “V-GROOVE ON” is selected.

Selecting the preset effect

Use the buttons on the unit for the operation.

Turn **OPERATION DIAL** clockwise or counterclockwise to select the preset effect you want.

Preset effect options

Effect	Category
ROCK	Standard music sources
POP	
JAZZ	
DANCE	
SOUL	
TECHNO	
HIP HOP	
MP3 EQ	MP3 audio tracks
FLAT	Original music source
USER EQ 1	User equalizer setting
USER EQ 2	
USER EQ 3	

To cancel the preset effect

Turn **OPERATION DIAL** clockwise or counterclockwise until “FLAT” appears in the display.

Note

To store the user equalizer setting, see “Adjusting the graphic equalizer and storing the user equalizer setting” on page 66.

Adjusting the graphic equalizer and storing the user equalizer setting

You can adjust the sound by raising or lowering the level of specific frequency band, then store up to three user equalizer setting in the memory. Use the buttons on the unit for the operation.

- 1 Press **EQ BAND** repeatedly to select a frequency band.
- 2 Turn **OPERATION DIAL** clockwise or counterclockwise to adjust the level.

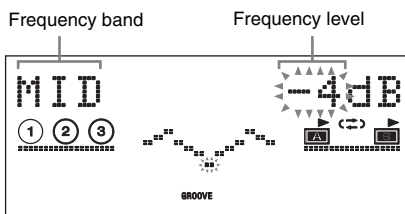

- 3 Repeat step 1 and 2 to adjust the level of other frequency bands.
- 4 Press **ENTER**.
A user equalizer number flashes in the display.
- 5 Turn **OPERATION DIAL** clockwise or counterclockwise to select a user equalizer number (1-3) you want to store the equalizer setting.
- 6 Press **ENTER**.

This setting is automatically stored as the user equalizer setting you selected in step 5. The previous setting stored at this memory location is erased and replaced by the new setting.

To cancel storing

Turn **OPERATION DIAL** clockwise or counterclockwise in step 5 to select “EXIT?”, then press **ENTER**.

To call up a user equalizer setting

Turn **OPERATION DIAL** clockwise or counterclockwise until the user equalizer setting number you want appears in the display.

Selecting the sound field

You can take advantage of surround sound simply by selecting one of the system preset sound fields. They bring the exciting and powerful sound of movie theaters into your home.

1 Press SOUND FIELD.

The last selected sound field appears in the display.

2 Press $\uparrow/\downarrow/\leftarrow/\rightarrow$ repeatedly (or turn OPERATION DIAL on the unit clockwise or counterclockwise) when the last selected sound field appears in the display to select the sound field you want.

The display changes as follows:

■ When the headphones are not connected

SBS MULTI¹⁾ \leftrightarrow A.F.D. AUTO¹⁾ \leftrightarrow

PRO LOGIC¹⁾ \leftrightarrow PLII MOVIE¹⁾ \leftrightarrow

PLII MUSIC¹⁾ \leftrightarrow V.M.DIM.¹⁾ \leftrightarrow

LINK \leftrightarrow 2CH STEREO

■ When the headphones are connected

HP 2CH \leftrightarrow HP VIRTUAL¹⁾

¹⁾These sound fields cannot be selected when

- the system is in standby for recording or recording.
- a microphone is connected.
- the Karaoke Mode is turned on.

• SBS MULTI (Sound Broadcasting System Multi mode):

Performs suitable decoding based on the source to maximize the sound field effect. This mode lets you enjoy audio playback from multiple speakers.

- A.F.D. AUTO (Auto Format Direct Auto):
The number of sound channels is depends on the source. During DVD function, playback of 2 channels source such as AUDIO CD, VIDEO CD and MP3 audio tracks would only output 2 sound channels where as the number of sound channels during playback of the DVD VIDEO is depend on audio format selection. During other functions, the system would only output 2 sound channels. This setting is ideal when you want to listen to the original sound from the source.
- PRO LOGIC:
Performs Pro Logic decoding. The source recorded in 2 channels is decoded into 4.1 channels.
- PLII MOVIE:
Performs Pro Logic II Movie mode decoding. This setting is ideal for movie encoded in Dolby Surround. In addition, this mode can reproduce 5.1 channels sound when watching videos of overdubbed or old movies.
- PLII MUSIC:
Performs Pro Logic II Music mode decoding. This setting is ideal for normal stereo sources such as AUDIO CDs.
- V.M.DIM.:
Performs DCS (Digital Cinema Sound) decoding. The source recorded in 2 channels is decoded into 5.1 channels.
- LINK:
MHC-GNV111D only
Reproduces the surround sound channels and center sound channel from the front sound channels output with different output levels.
MHC-GNV99D only
Reproduces the surround sound channels from the front sound channels output with different output levels.
- 2CH STEREO:
Reproduces stereo output from multi channel source such as DVD VIDEOS during DVD function. During other function, the system output the original sound.
- HP 2CH:
The normal sound field for headphones.
- HP VIRTUAL:
The sound field for headphones with virtual surround effect.

Notes

- Depending on the disc, the surround effect may not be as much as expected.
- You can also press SOUND FIELD repeatedly to select the sound field you want.

Tips

- “PRO LOGIC” lights up in the display when Pro Logic decoding is performed.
- “PRO LOGIC II” lights up in the display when Pro Logic II Movie/Music mode decoding is performed.
- “LINK” lights up in the display when “LINK” is selected.
- “VIRTUAL” lights up in the display when “HP VIRTUAL” is selected.
- “VIRTUAL” and “**DCS**” light up in the display when “V.M.DIM.” is selected.

Flashing sound effect

— SOUND FLASH

With the sound flash function, you can flash the sound output. The sound cuts off periodically. Use the buttons on the unit for the operation.

Hold down SOUND FLASH during playback.

The flashing effect is activated.

To cancel the flashing effect

Release SOUND FLASH.

To change the sound flash speed

Hold down SOUND FLASH and turn OPERATION DIAL clockwise or counterclockwise to change the sound flash speed (1 ~ 20).

Tips

- MHC-GNV111D only
You can activate the X-ROUND and SOUND FLASH effect simultaneously.
- The power illuminator will synchronize with the selected SOUND FLASH effect.

Creating a party environment

(MHC-GNV111D only)

You can create a party environment by using X-ROUND for “moving” sound effect or/and SOUND FLASH for flashing effect.

To enjoy the X-ROUND effect, place your front and surround speakers at an equal distance from your listening position (see “Positioning the speakers (Example 1)” on page 13).

Moving sound effect

— X-ROUND

Use the buttons on the unit for the operation.

Press one of the X-ROUND buttons to select the X-ROUND mode you want.

The name of selected X-ROUND mode appears and the X-ROUND lights up in the display.

Tip

To change between AUTO WAVE and MANUAL WAVE, AUTO FADER and MANUAL FADER or AUTO BAL and MANUAL BAL, press AUTO/MANUAL repeatedly until the mode you want appears in the display.

Select	To output sound
AUTO WAVE ¹⁾ , MANUAL WAVE ²⁾	In circular motion
AUTO FADER ¹⁾ , MANUAL FADER ²⁾	From front speakers to surround speakers or vice versa
AUTO BAL ¹⁾ , MANUAL BAL ²⁾	From left speakers to right speakers or vice versa
RANDOM	In random position
TWISTER	In circular motion like “twister”

1) You can change the speed of sound movement by turning the X-ROUND JOG clockwise or counterclockwise.

2) You can manually change the sound movement from one speaker to another speaker by turning the X-ROUND JOG clockwise or counterclockwise.

To cancel the X-ROUND effect

Press X-ROUND OFF. “X-ROUND OFF” appears in the display.

Notes

- If you cannot get the sound effect you want, check the speaker connections.
- When the headphones are connected to the PHONES jack, X-ROUND mode automatically turned off and you cannot change the setting.
- When the X-ROUND mode is turned on, the audio output from the center speaker and subwoofer is cut off.
- When you press SOUND FIELD or turn on the test tone, X-ROUND mode is automatically turned off.
- You cannot turn on the X-ROUND mode when
 - the headphones are connected.
 - the “SURROUND” in “SPEAKER SETUP” is set to “NONE”.
 - the test tone is performed.

Listening to the sound in another room

(MHC-GNV111D only)

You can select the speakers you want to turn on.

Press **SPEAKERS** on the unit.

Each time you press the button, the display changes cyclically as follows:

SPEAKERS A → SPEAKERS B →
SPEAKERS A+B

To select	Display
The front speakers	SPEAKERS A
The surround speakers	SPEAKERS B
Both the front and surround speakers	SPEAKERS A+B

Notes

- You cannot change the setting when
 - the headphones are connected.
 - the “SURROUND” in “SPEAKER SETUP” is set to “NONE”.
 - the test tone is performed.
- “SPEAKERS A” lights up in the display when SPEAKERS A is selected while “SPEAKERS B” lights up in the display when SPEAKERS B is selected.
- When you select “SPEAKERS B”, the audio output of optional subwoofer is cut off.
- When you press SOUND FIELD or turn on the test tone, this function is automatically turned off.

Singing along: Karaoke



You can sing along with any multiplex AUDIO CD, multiplex VIDEO CD or DVD VIDEO in Dolby Digital Karaoke format. You need to connect an optional microphone.

Preparing for karaoke

(DVD VIDEO, DVD-RW in VR mode, VIDEO CD, AUDIO CD, MP3 audio tracks and DivX video files only)

- 1 Press FUNCTION +/- repeatedly to select “DVD” (or press DVD on the unit).**
- 2 Turn MIC LEVEL on the unit to MIN to reduce the microphone volume and turn ECHO LEVEL on the unit to MIN to cancel the echo effect.**
- 3 Connect an optional microphone to MIC 1 or MIC 2 jack on the unit.**

Connect another optional microphone if you want to sing in duet.
The Karaoke Mode is turned on.
“KARAOKE MODE: ON” is displayed in the on-screen display and “” lights up in the display.
- 4 Start playing the music and adjust the volume.**

When Karaoke Mode is turned on during playback of DVD VIDEOS, the system outputs the audio format that you select. In the case when Karaoke Mode is turned on during playback of AUDIO CD or VIDEO CD, the “AUDIO” setting automatically changed to “1/L” and the system outputs left channel audio on both front channels. If you heard vocal during Karaoke Mode is turned on, press AUDIO repeatedly to select another audio channel.

- 5 Start singing along with music and adjust the microphone volume by turning MIC LEVEL on the unit.**

To adjust microphone echo

Turn ECHO LEVEL on the unit to adjust the echo effect. To cancel the echo effect, turn ECHO LEVEL on the unit to MIN.







Notes

- You can also turn on the Karaoke Mode by pressing KARAOKE MODE.
- During Karaoke Mode is turned on, you can turn off the Karaoke Mode either by disconnecting all the microphones or pressing KARAOKE MODE.
- If acoustic feedback (howling) occurs, move the microphone away from the speakers or change the direction of the microphone.
- Karaoke Mode is automatically turned off when you
 - turn off the system.
 - change the function.
 - connect the headphones.
 - turn on the test tone.

Singing karaoke by reducing the vocal

(DVD VIDEO, DVD-RW in VR mode, VIDEO CD, AUDIO CD, MP3 audio tracks and DivX video files only)

By reducing the sound of the vocal, you can enjoy karaoke with any disc, even it is not a karaoke or multiplex disc.

- 1** Press  DISPLAY once or twice during Karaoke Mode is turned on while playing a disc.
The Control Menu appears in the on-screen display.
- 2** Press  or  repeatedly to select  (KARAOKE PON), then press ENTER.
The options for “KARAOKE PON” appear in the on-screen display.
- 3** Press  or  repeatedly to select “ON”, then press ENTER.
The vocal is reduced.

Notes

- The singer’s voice may not be reduced when
 - only a few instruments are playing.
 - a duet is being played back.
 - the source has strong echoes or chorus.
 - the singer’s voice deviates from the center.
 - the voice on the source is singing in high soprano or tenor.
- To cancel the effect of “KARAOKE PON”, select “OFF” in step 3.
- You can also change the “KARAOKE PON” setting by pressing KARAOKE PON when the Karaoke Mode is turned on. The following display appears in the on-screen display.

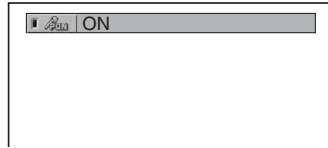





- The “KARAOKE PON” setting is automatically changed to “OFF” when you
 - turn off the system.
 - change the function.
 - turn off the Karaoke Mode.
 - open the disc tray.
 - change the disc.
 - set the “VOCAL” to “ON”.

Adjusting the pitch of the music

(DVD VIDEO, DVD-RW in VR mode, VIDEO CD, AUDIO CD, MP3 audio tracks and DivX video files only)

You can adjust the pitch of the music to suit your vocal range. You can adjust the key higher or lower in 14 half-tone steps.

- 1** Press  DISPLAY once or twice during Karaoke Mode is turned on while playing a disc.
The Control Menu appears in the on-screen display.
- 2** Press  or  repeatedly to select  (KEY CONTROL), then press ENTER.

continued

3 Press **↑** or **↓** repeatedly to select the key you want.

The key is changed.

Notes

- You can also change the “KEY CONTROL” setting by pressing KEY CONTROL **D** to reduce the key and KEY CONTROL **#** to increase the key when Karaoke Mode is turned on. The following display appears in the on-screen display.

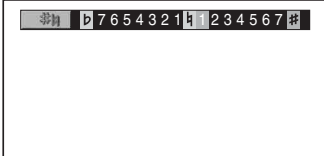

- The “KEY CONTROL” setting is automatically changed to default setting when you
 - turn off the system.
 - change the function.
 - turn off the Karaoke Mode.
 - open the disc tray.
 - change the disc.
 - change the track or title.
- Depending on the disc, you may not be able to do the above operation.
- To cancel the effect of “KEY CONTROL”, select “**h**” in step 3.

Turning on the vocals



When you play back a DVD VIDEO in Dolby Digital Karaoke format during Karaoke Mode is turned on, you can turn on the guide vocal recorded in the tracks.

When you play back an AUDIO CD or VIDEO CD during Karaoke Mode is turned on, you can turn on the vocal either by selecting “STEREO” or “L+R”.

1 Press **DISPLAY** once or twice during Karaoke Mode is turned on while playing a disc.

The Control Menu appears in the on-screen display.

2 Press **↑** or **↓** repeatedly to select **(VOCAL)**, then press **ENTER**.

The options for “VOCAL” appear in the on-screen display.

3 Press **↑** or **↓** repeatedly to select “ON”, then press **ENTER**.

The vocal is turned on.

■ During playback of a DVD VIDEO

You can listen to the guide vocal recorded in the Dolby Digital Karaoke format.

■ During playback of an AUDIO CD or VIDEO CD

When Karaoke Mode is turned on, the system outputs the left channel (accompaniment channel) from both front speakers. You can listen to the vocal when you set the “VOCAL” to “ON”.

Notes

- To turn off the vocal, select “OFF” in step 3.
- You cannot turn on the vocal during playback of the DVD VIDEO without guide vocal recorded.
- When playing a DVD VIDEO, this function only work for Dolby Digital Karaoke format.
- The “VOCAL” setting is automatically changed to “OFF” when you
 - turn off the system.
 - change the function.
 - turn off the Karaoke Mode.
 - open the disc tray.
 - change the disc.
 - set the “KARAOKE PON” to “ON”.

Dolby Digital Karaoke format



Dolby Digital format, which reproduces surround sound using 5 channels, can also contain the “Dolby Digital Karaoke” format which is specialized for karaoke. In the Dolby Digital Karaoke format discs, guide melody and guide vocal tracks are recorded in addition to the accompaniment. You can select them when Karaoke Mode is turned on.

Speaker output in normal Dolby Digital format (5.1 channel)

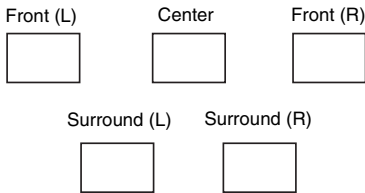

Speaker output in Dolby Digital Karaoke format

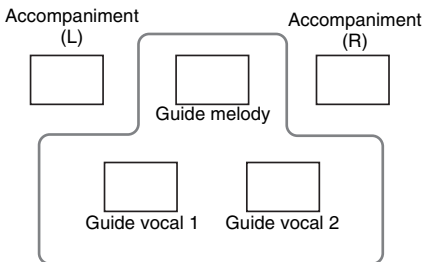

You can select any of these. These are output from the front speakers.

You can check the audio information using AUDIO button (page 39). When playing a Dolby Digital Karaoke disc, “♪” appears at the current audio format (page 39).

Example:

DOLBY DIGITAL ♪ 3/2

- 2/0: Recorded only with accompaniment.
- 3/0: Recorded with guide melody.
- 3/1: Recorded with guide melody and 1 kind guide vocal.
- 3/2: Recorded with guide melody and two kinds of guide vocals.

Selecting the Vocals



After you set the “VOCAL” to “ON”, you can change the vocal type.

- 1** Press **DISPLAY** once or twice during Karaoke Mode is turned on while playing a disc.

The Control Menu appears in the on-screen display.

- 2** Press **↑** or **↓** repeatedly to select (**VOCAL SELECT**), then press **ENTER**.

The options for “VOCAL SELECT” appear in the on-screen display.

- 3** Press **↑** or **↓** repeatedly to select the vocal type you want, then press **ENTER**.

The vocal is changed.

■ When playing a DVD VIDEO

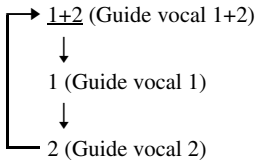

■ When playing a VIDEO CD or AUDIO CD

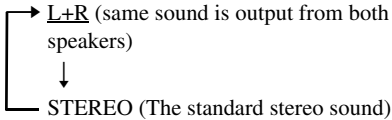

■ When playing a Super VCD

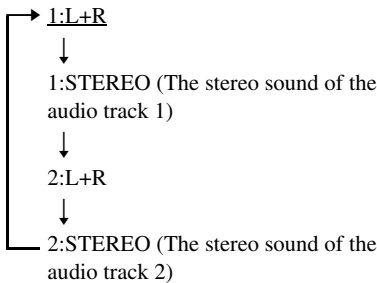

Notes

- You cannot change the vocal during playback of the DVD VIDEO with 1 guide vocal recorded.
- When playing a DVD VIDEO, the function only work for Dolby Digital Karaoke format.
- The “VOCAL SELECT” setting is automatically changed to default setting when you
 - turn off the system.
 - change the function.
 - turn off the Karaoke Mode.
 - open the disc tray.
 - change the disc.
- Depending on the disc, you may not be able to do the above operation.

Turning on the guide melody



You can turn on the guide melody when singing with DVD VIDEO in Dolby Digital Karaoke format.

1 Press DISPLAY once or twice during Karaoke Mode is turned on while playing a disc.

The Control Menu appears in the on-screen display.

2 Press or repeatedly to select (GUIDE MELODY), then press ENTER.

The options for “GUIDE MELODY” appear in the on-screen display.

3 Press or repeatedly to select “ON”, then press ENTER.

The guide melody is turned on.



Notes

- To turn off the guide melody, select “OFF” in step 3.
- When playing a DVD VIDEO, the function only work for Dolby Digital Karaoke format.
- For the DVD VIDEO without guide melody, you cannot hear the guide melody even you set the setting to “ON”.
- The “GUIDE MELODY” setting is automatically changed to “OFF” when you
 - turn off the system.
 - change the function.
 - turn off the Karaoke Mode.
 - open the disc tray.
 - change the disc.

Mixing and recording sounds

You can “mix” sounds from any one of the function and singing or speaking into a microphone.

The mixed sound can be recorded into a tape. Use buttons on the unit for the operation.

- 1 Turn MIC LEVEL to MIN to turn down the microphone volume.**
- 2 Connect an optional microphone to MIC 1 or MIC 2 jack.**
- 3 Prepare the music source you want to mix. Then, insert a recordable tape into Deck B.**
- 4 Press the function button of the source you want to record (e.g., DVD).**
If you want to record from TAPE A, press TAPE A/B repeatedly to select “TAPE A”.
- 5 Press REC PAUSE/START.**
“REC” flashes in the display. Deck B standby for recording.
- 6 Press DIRECTION repeatedly to select “” to record on one side. Select “” (or “RELAY”) to record on both sides.**
- 7 Press REC PAUSE/START.**
“REC” lights up in the display.
Recording starts.
- 8 Start playing the source to be recorded.**
Start singing along with the music.
- 9 Adjust the microphone volume by turning MIC LEVEL.**

To stop recording

Press .



After you have finished

Turn MIC LEVEL to MIN and disconnect the microphone from MIC 1 or MIC 2 jack.

Note

During DVD function, the Karaoke Mode is automatically turned on when you connect an optional microphone to MIC 1 or MIC 2 jack.

Tips

- For recording from the reverse side:
After step 3, press TAPE A/B repeatedly to select “TAPE B”. Press  repeatedly until TAPE B reverse side indicator lights up to start playback of reverse side. Press  at the point you want to start recording.
- When you record on both sides, be sure to start from the front side. If you start from the reverse side, recording stops at the end of the reverse side.
- If acoustic feedback (howling) occurs, move the microphone away from the speakers or change the direction of the microphone.
- If you want to record your voice through the microphone only, you can do so by selecting the TAPE A or TAPE B function and not playing any tape.
- When high level sound signals are input, the system automatically adjust the recording level to prevent distortion of the recorded sound signals (Auto Level Control Function).

Timer

Falling asleep to music

— Sleep Timer

You can set the system to turn off after a certain time, so that you can fall asleep to music.

Press SLEEP repeatedly.

Each time you press the button, the minute display (the turn-off time) changes cyclically as follows:

90min → 80min → 70min
→ ... → 10min → OFF

Other operations

To	Do this
Check the remaining time	Press SLEEP once.
Change the time to turn off	Press SLEEP repeatedly to select the time you want.
Cancel the Sleep Timer	Press SLEEP repeatedly until “SLEEP OFF” appears in the display.

Note

“SLEEP” lights up in the display when the Sleep Timer is activated.

Tip

You can use the Sleep Timer even if you have not set the clock.

Waking up to music

— Play Timer

You can wake up to music at a preset time. Make sure you have set the clock (see “Setting the clock” on page 14).

- 1 Prepare the music source you want to playback.**
 - Disc: Load a disc.
 - Tape: Load a tape with the side you want to play back facing forward.
 - Radio: Tune in the preset station you want (see “Listening to the radio” on page 61).
- 2 Press VOLUME +/- (or turn MASTER VOLUME on the unit clockwise or counterclockwise) to adjust the volume.**
- 3 Press TIMER MENU.**
- 4 Press ↑ or ↓ repeatedly (or turn ◀▶▶▶▶▶ on the unit clockwise or counterclockwise) to select “PLAY SET?”, then press ENTER.**

“ON” appears and the hour indication flashes in the display.
- 5 Set the time to start playback.**

Press ↑ or ↓ repeatedly (or turn ◀▶▶▶▶▶ on the unit clockwise or counterclockwise) to set the hour, then press ENTER. The minute indication flashes in the display. Press ↑ or ↓ repeatedly (or turn ◀▶▶▶▶▶ on the unit clockwise or counterclockwise) to set the minute, then press ENTER. “OFF” appears and the hour indication flashes in the display.
- 6 Set the time to stop playback following the same procedure as step 5.**

7 Press **↑** or **↓** repeatedly (or turn **⏪⏩** on the unit clockwise or counterclockwise) until the music source you want appears in the display.

Each time you press the button, the display changes as follows:

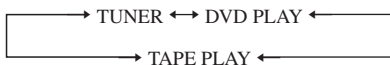

8 Press **ENTER**.

The type of timer (“PLAY TIMER”), followed by the start time, the stop time and the music source appears in the display in sequence before the original display returns.

9 Press **I/⏻** to turn off the system.

Other operations

To	Do this
Check the setting	<ol style="list-style-type: none"> 1 Press TIMER MENU. “TIMER SELECT?” appears in the display. 2 Press ENTER. 3 Press ↑ or ↓ repeatedly (or turn ⏪⏩ on the unit clockwise or counterclockwise) to select “PLAY SELECT?”, then press ENTER.
Change the setting	Start from step 1.
Cancel the Play Timer	<ol style="list-style-type: none"> 1 Press TIMER MENU. “TIMER SELECT?” appears in the display. 2 Press ENTER. 3 Press ↑ or ↓ repeatedly (or turn ⏪⏩ on the unit clockwise or counterclockwise) to select “TIMER OFF?”, then press ENTER.

Notes

- You cannot select the Play Timer and Timer Recording at the same time.
- If you use the Play Timer and the Sleep Timer at the same time, the Sleep Timer has priority.
- The Play Timer will not be activated if the system is turned on or “STANDBY” flashes in the display.

Tips

- The system turns on 30 seconds before the preset time.
- When Play Timer is selected, “PLAY” lights up in the display.

Timer recording radio programs

You can record from a preset radio station from a specified time.

To make timer recording, you must first preset the radio station (see “Presetting radio stations” on page 59) and set the clock (see “Setting the clock” on page 14).

1 Tune in the preset radio station (see “Listening to a preset radio station” on page 61).

2 Press **TIMER MENU**.

3 Press **↑** or **↓** repeatedly (or turn **◀▶▶▶▶▶** on the unit clockwise or counterclockwise) to select “**REC SET?**”, then press **ENTER**.

“ON” appears and the hour indication flashes in the display.

4 Set the time to start recording.

Press **↑** or **↓** repeatedly (or turn **◀▶▶▶▶▶** on the unit clockwise or counterclockwise) to set the hour, then press **ENTER**.

The minute indication flashes in the display.

Press **↑** or **↓** repeatedly (or turn **◀▶▶▶▶▶** on the unit clockwise or counterclockwise) to set the minute, then press **ENTER**.

“OFF” appears and the hour indicator flashes in the display.

5 Set the time to stop recording following the same procedure as step 4.

The type of timer (“REC”), followed by the start time, the stop time and the preset radio station to be recorded (e.g., “TUNER FM 5”) appears in the display in sequence before the original display returns.

6 Load a recordable tape into Deck B.
Make sure the tape is in front side.

7 Press **DIRECTION** on the unit repeatedly to select “**↔**” to record on one side or “**↔↔**” (or “**RELAY**”) to record on both sides.

For recording from the reverse side, press **FUNCTION +/-** (or **TAPE A/B** on the unit) repeatedly to select “**TAPE B**”. Then, press **▷** (or **◀▶▶▶▶▶** on the unit) repeatedly until **TAPE B** reverse side indicator lights up to start playback of reverse side. Press **■** at the point where you want to start recording. When you record on both sides, be sure to start from the front side. If you start from the reverse side, recording stops at the end of reverse side.

8 Press **I/⏻** to turn off the system.

Other operations

To	Do this
Check the setting	<ol style="list-style-type: none"> 1 Press TIMER MENU. “TIMER SELECT?” appears in the display. 2 Press ENTER. 3 Press ↑ or ↓ repeatedly (or turn ◀▶▶▶▶▶ on the unit clockwise or counterclockwise) to select “REC SELECT?”, then press ENTER.
Change the setting	Start from step 1.
Cancel the Timer Recording	<ol style="list-style-type: none"> 1 Press TIMER MENU. “TIMER SELECT?” appears in the display. 2 Press ENTER. 3 Press ↑ or ↓ repeatedly (or turn ◀▶▶▶▶▶ on the unit clockwise or counterclockwise) to select “TIMER OFF?”, then press ENTER.

Notes

- You cannot select the Play Timer and Timer Recording at the same time.
- If you use the Timer Recording and the Sleep Timer at the same time, the Sleep Timer has priority.
- The Timer Recording will not be activated if the system is turned on or “STANDBY” flashes in the display.
- The volume is reduced to minimum during Timer Recording.
- Do not operate the system from the time the system turns on until the recording starts (about 30 seconds before the preset time).

Tips

- The system turns on 30 seconds before the preset time.
- When Timer Recording is selected, “REC” lights up in the display.

Display**Turning off the display****— Power Saving Mode**

The demonstration display and the clock display can be turned off to minimize the amount of power consumed during standby mode (Power Saving Mode).

Press DISPLAY repeatedly while the system is turned off until the demonstration display and the clock display disappears.

To cancel Power Saving Mode

Press DISPLAY repeatedly while the system is turned off. Each time you press the button, the display changes cyclically as follows:
 Demonstration¹⁾ → Clock²⁾ → No display (Power Saving Mode)

¹⁾ The display changes and the indicators flashes even when the system is turned off.

²⁾ “- -: -” appears in the display if you have not set the clock.

Note

You cannot perform the following operations during Power Saving Mode:

- Setting the clock (page 14)
- Changing the AM tuning interval (page 60)
- Turning on the system by pressing DVD, TUNER/BAND, TAPE A/B, TV/SAT or VIDEO on the unit.
- Changing the color system (page 11)

Tips

- The timer continues to operate in Power Saving Mode.
- I/⏻ indicator lights up in red even in the Power Saving Mode.

Changing the spectrum analyzer display

Use buttons on the unit for the operation.

- 1 Press **AMP MENU** repeatedly to select “**SPECTRUM**”.

The last selected spectrum setting appears in the display.

- 2 Turn **OPERATION DIAL** clockwise or counterclockwise to select the setting you want.

The display changes as follows:



- 3 Press **ENTER**.

MHC-GNV111D only

When X-ROUND mode is selected

- 1 Press **AMP MENU** repeatedly to select “**X-POSITION**”.

The last selected spectrum setting appears in the display.

- 2 Turn **OPERATION DIAL** clockwise or counterclockwise to select the setting you want.

The display changes as follows:

X-POS ON* ↔ X-POS OFF

*The spectrum analyzer display will synchronize with the selected X-ROUND effect.

- 3 Press **ENTER**.

Adjusting the brightness of the front panel display

Use buttons on the unit for the operation.

- 1 Press **AMP MENU** repeatedly to select “**DIMMER**”.

The last selected dimmer setting appears in the display.

- 2 Turn **OPERATION DIAL** clockwise or counterclockwise to select the setting you want.

The display changes as follows:

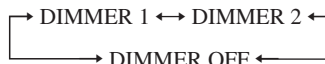

- 3 Press **ENTER**.

Changing the power illuminator

Press **ILLUMINATION** on the unit repeatedly to select the power illuminator you want when the system is turned on.

Each time you press the button, the power illuminator changes cyclically as follows:

PATTERN 1 → PATTERN 2 →
PATTERN 3 → PATTERN 4 →
PATTERN OFF

Notes

- When you press **VOLUME +/-** (or turn **MASTER VOLUME** on the unit clockwise or counterclockwise), the power illuminator shows the current volume level.
- During the demonstration display, you can turn on or off the power illuminator by pressing **ILLUMINATION** on the unit.

Viewing information about the disc in the front panel display

You can check the elapsed playing time and remaining time of the current track or the disc. When a DVD-TEXT disc, CD-TEXT disc, DATA CD or DATA DVD is loaded, you can also check the information recorded on disc, such as the titles.

Press **DISPLAY** repeatedly.

Each time you press the button, the display changes cyclically as follows:
Disc information → Clock display¹⁾ (for 8 seconds) → Effect status (for 8 seconds)

Checking the elapsed playing time, remaining time and titles

Press **TIME/TEXT** repeatedly during playback.

Each time you press the button, the display changes cyclically as follows:

■ When playing a DVD VIDEO or DVD in VR mode

- When the menu or the title without a chapter is played back
Elapsed playing time of the menu or the current title → Title of the disc²⁾
- When a chapter other than above condition is played back
Elapsed playing time of the current title →
Remaining time of the current title →
Elapsed playing time of the current chapter →
Remaining time of the current chapter →
Title of the disc²⁾³⁾

■ When playing an AUDIO CD or VIDEO CD without PBC function

Elapsed playing time of the current track →
Remaining time of the current track → Elapsed playing time of the current disc⁴⁾ → Remaining time of the current disc⁴⁾ → Title of the disc²⁾⁶⁾

■ **When playing a VIDEO CD/Super VCD with PBC function**

Elapsed playing time of the current scene → Title of the disc²⁾⁷⁾

■ **When playing a Super VCD without PBC function**

Elapsed playing time of the current track → Title of the disc²⁾⁶⁾

■ **When playing a DATA CD (MP3 audio tracks)**

Elapsed playing time of the current track → Title of the track

■ **When playing a DATA CD (DivX video files) or DATA DVD (DivX video files)**

Elapsed playing time of the current file → Title of the file³⁾

Checking the total playing time and titles

Press TIME/TEXT repeatedly when the playback is stopped.

Each time you press the button, the display changes cyclically as follows:

■ **DVD VIDEO or DVD-RW in VR mode**

Total number of titles on the disc → Title of the disc²⁾

■ **VIDEO CD without PBC playback or AUDIO CD**

Total number of the tracks on the disc and the total playing time of the disc → Title of the disc²⁾

■ **VIDEO CD with PBC playback**

Total number of scene on the disc → Title of the disc²⁾

- 1) “- -: -” appears in the display if you have not set the clock.
- 2) “NO TEXT” appears in the display if the DVD VIDEO is not a DVD-TEXT disc, the AUDIO CD is not a CD-TEXT disc or the VIDEO CD do not have text information.
- 3) The current chapter number and the current title number is displayed for 2 seconds before the display returns to elapsed playing time when you press TIME/TEXT during display of title of the disc.
- 4) When the Program Play or Shuffle Play is On, the elapsed playing time and the remaining time of the disc would be skipped.
- 5) The current album number and the current file number is displayed for 2 seconds before the display returns to elapsed playing time when you press TIME/TEXT during display of title of the file.
- 6) The current track number and current index number is displayed for 2 seconds before the display returns to elapsed playing time when you press TIME/TEXT during display of the title of disc.
- 7) The current scene number is displayed for 2 seconds before the display returns to elapsed playing time when you press TIME/TEXT during display of title of the disc.

Notes

- If you play back a disc containing JPEG image files only, “JPEG” or “No Audio” message appears in the display.
- When the selected disc is DATA CD with MP3 audio tracks and/or JPEG image files or DATA CD/DATA DVD with DivX video files, the total number of albums on the disc appears in the display when playback is stopped and the list of album/title/file is not displayed on the on-screen display.
- You cannot change the display of disc information by pressing TIME/TEXT
 - during playback of a JPEG image file.
 - when playback is stopped for DATA CD with MP3 audio tracks and/or JPEG image files.
 - when playback is stopped for DATA CD or DATA DVD with DivX video files.
- If the title of MP3 audio track containing the characters which cannot be displayed, these characters will be displayed as “*”.
- Elapsed playing time of MP3 audio tracks and DivX video files may not be displayed correctly.

Viewing information about the disc in the on-screen display

You can check the elapsed playing time and remaining time of the current title, chapter, or track, and the total playing time of the disc. You can also check the disc title, track title and file title recorded on the disc.

Press TIME/TEXT repeatedly during playback to change the time information.

The display and the kinds of the time that you can change depend on the disc you are playing.

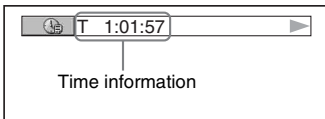

■ When playing a DVD VIDEO or DVD-RW in VR mode

- T **: **: **
Elapsed playing time of the current title
- T_ **: **: **
Remaining time of the current title
- C **: **: **
Elapsed playing time of the current chapter
- C_ **: **: **
Remaining time of the current chapter
- **: **: **
Elapsed playing time of the menu or current title without a chapter

■ When playing a VIDEO CD/Super VCD with PBC function

- **: **: **
Elapsed playing time of the current scene

■ When playing a Super VCD without PBC function

- T **: **: **
Elapsed playing time of the current track

■ When playing an AUDIO CD or VIDEO CD without PBC function

- T **: **: **
Elapsed playing time of the current track
- T _ **: **: **
Remaining time of the current track
- D **: **: **
Elapsed playing time of the current disc
- D _ **: **: **
Remaining time of the current disc

■ When playing a DATA CD (MP3 audio tracks)

- T **: **: **
Elapsed playing time of the current track

■ When playing a DATA CD (DivX video files) or DATA DVD (DivX video files)

- **: **: **: **
Elapsed playing time of the current file

Notes

- Only alphabet letters, numbers and some symbols can be displayed.
- Depending on the type of disc being played back, the system can only display a limited number of characters. Depending on the disc, not all text characters are displayed.
- With format other than ISO 9660 Level 1 and Level 2, album title and track title may not be displayed.

Checking the date information of JPEG image files

(JPEG image file only)

You can check the date information during playback when Exif* tag is recorded in the JPEG image files.

Press **DISPLAY** repeatedly during playback until the Control Menu for JPEG image files appears in the on-screen display.

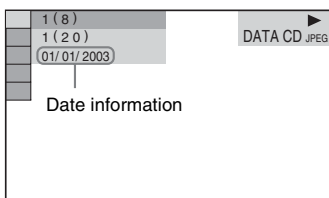

* “Exchangeable Image File Format” is a digital camera image format defined by the Japan Electronics & Information Technology Industries Association (JEITA).

Notes

- If there is no date information or data is damaged on the disc, the system cannot display the date information.
- The format of date information varies depending on the area.

Optional Components

Hooking up optional components

To enhance your system, you can connect optional components. Refer to the operating instructions provided with each component.

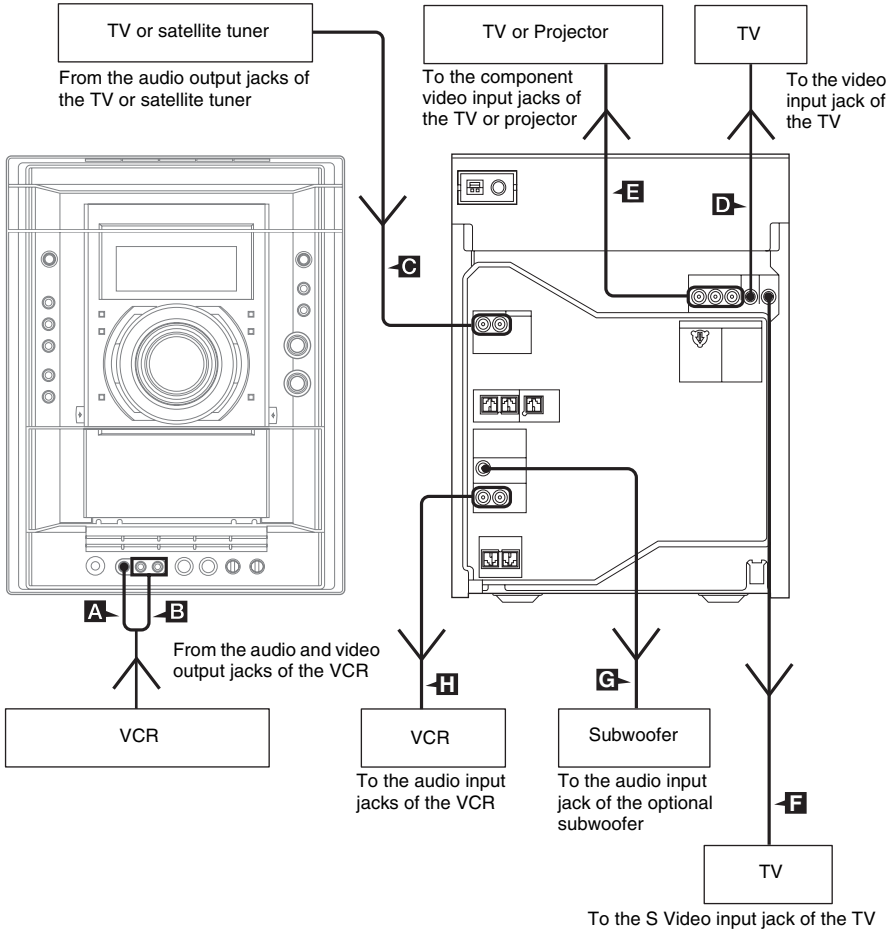

A VIDEO INPUT VIDEO jack

Use a video cord (not supplied) to connect the video output jack of the VCR to this jack. You can then output video signal through this system.

B VIDEO INPUT AUDIO L/R jacks

Use audio cords (not supplied) to connect the audio output jacks of the VCR to these jacks. You can then output audio signal through this system.

C TV/SAT AUDIO IN L/R jacks

Use audio cords (not supplied) to connect the audio output jacks of an optional component (such as TV or satellite tuner) to these jacks. You can then output audio signal through this system.

D VIDEO OUT jack

Use a video cord (supplied) to connect the video input jack of the TV to this jack.

E COMPONENT VIDEO OUT jacks

Use the optional video cords (not supplied) to connect the component video input jacks of the TV to these jacks. If your TV accept progressive format signals, you must use this connection and press PROGRESSIVE on the unit repeatedly to select "P AUTO" or "P VIDEO". You can enjoy higher quality video images.

Note

You cannot output video signal from the VIDEO INPUT VIDEO jack through the COMPONENT VIDEO OUT jacks of this unit.

F S VIDEO OUT jack

Use an S video cord (not supplied) to connect the S video input jack of the TV to this jack. You can enjoy higher quality video images.

Note

You cannot output video signal from the VIDEO INPUT VIDEO jack through the S VIDEO OUT jack of this unit.

G SUBWOOFER OUT jack

Use an audio cord (not supplied) to connect the audio input jack of an optional subwoofer* to this jack.

* SA-GNV111D is recommended.

In some areas, the SA-GNV111D may not yet be available.

Note

The effect may be limited or noise may occur depending on the connected subwoofer or the type of music being played back. For details, consult your nearest Sony dealer.

H AUDIO OUT jacks

Use audio cords (not supplied) to connect the audio input jacks of an optional component (such as VCR) to these jacks. You can then output audio signal to that component from this system.

Note

There is no audio output from these jacks during VIDEO, SAT or TV function.

Listening to audio from a connected component

Listening to a connected TV or satellite tuner

Use buttons on the unit for the operation.

1 Connect the audio cords.

See “Hooking up optional components” on page 85.

2 Press TV/SAT.

To switch between the “TV” and “SAT” function

Hold down TV/SAT and press I/⏻ while the system is turned on. Release I/⏻ first, then release TV/SAT. The system switches the function from “TV” to “SAT” or vice versa.

Note

If the sound is distorted or too loud when “TV” is selected, change the function to “SAT”.

Listening to a connected VCR

1 Connect the audio and video cords.

See “Hooking up optional components” on page 85.

2 Press VIDEO on the unit.

Start playing the connected VCR.

Note

The video signal from the connected VCR only output through the VIDEO OUT jack of this unit.

Tip

You can press FUNCTION +/- repeatedly to select “TV”, “SAT” or “VIDEO”.

Recording audio signal from a connected component

1 Connect the audio cords.

See “Hooking up optional components” on page 85.

2 Start recording manually.

See “Recording on a tape manually” on page 64.

Recording audio signal on a connected component

Recording the audio signal on a connected component

- 1 Connect the audio cords.**
See “Hooking up optional components” on page 85.
- 2 Start recording.**
Refer to the operating instructions provided with connected component.

Recording the audio and video signals from a VIDEO CD into a video tape

- 1 Connect optional audio cords from the AUDIO OUT jacks and the supplied video cord from the VIDEO OUT jack to the audio and video input jacks of you VCR.**
- 2 Start recording.**

Refer to the operating instructions provided with connected component.

Note

The audio signal from AUDIO OUT jack cuts off for a moment during some operations such as when you press SOUND FIELD, AUDIO or KARAOKE MODE.

Connecting external antennas

Connect an external antenna to improve the reception.

FM antenna

Connect an optional FM external antenna. You can also use the TV antenna instead.

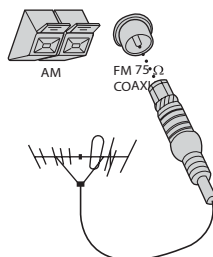

AM antenna

Connect a 6 to 15 meter insulated wire to the AM antenna terminal. Leave the supplied AM loop antenna connected.

Insulated wire
(not supplied)

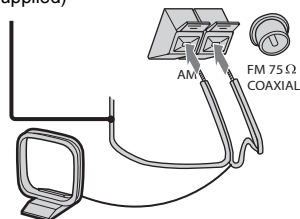

Troubleshooting

Problems and remedies

Should you encounter a problem with your system, do the following:

- 1 Make sure the power cord and speaker cords are connected correctly and firmly.
- 2 Find your problem in the troubleshooting checklist below and take the indicated corrective action.

If the problem persists after doing all of the above, consult your nearest Sony dealer.

When the I/⏻ indicator flashes

Immediately unplug the power cord and check the following items.

- If your unit have a voltage selector, is the voltage selector set to the correct voltage? Check the voltage for your region, then make sure the voltage selector is set correctly.
- Are the + and – speaker cords short-circuited?
- Are you using the supplied speakers?
- Is anything blocking the ventilation holes on the rear of the unit?

After checking the above items and fixing any problems, plug in the power cord again and turn on the unit. If the I/⏻ indicator still flashes, or if the cause of the problem cannot be found even after checking all the above items, consult your nearest Sony dealer.

General

The display starts flashing as soon as you plug in the power cord even though you have not turned on the system.

- The demonstration mode started. Press I/⏻ (see step 7 of “Hooking up the system” on page 11).

The clock or timer setting is canceled.

- The power cord is disconnected or a power failure occurred. Redo “Setting the clock” (page 14). If you have set the timer, redo “Waking up to music” (page 76) and “Timer recording radio programs” (page 78).

The radio presetting is canceled.

- The power cord is disconnected or a power failure occurred for longer than half a day. Redo “Presetting radio stations” (page 59).

“- -:-” appears in the display.

- A power failure has occurred. Set the clock (page 14) and timer settings (page 76 and 78) again.

There is no sound.

- Press VOLUME + repeatedly (or turn MASTER VOLUME on the unit clockwise).
- The headphones are connected to the PHONES jack.
- Check the speaker connections (page 10).
- There is no audio output during Timer Recording.
- The system is in pause mode, in Slow-motion Play or in Lock Search. Press ▷ (or ◀▶ on the unit) to start the playback.

There is no microphone sound.

- Press VOLUME + repeatedly (or turn MASTER VOLUME on the unit clockwise) or turn MIC LEVEL on the unit clockwise to adjust the microphone volume.
- Make sure the microphone is connected to the MIC 1 or MIC 2 jack correctly.

There is severe hum or noise.

- A TV or VCR is placed too close to the unit. Move the unit away from the TV or VCR.
- Move the unit away from the source of noise.
- Connect the unit to a different wall outlet.
- Install a noise filter (commercially available) to the power cord.

The timer does not function.

- Check the timer setting and set the correct time (page 76 and 78).
- Cancel the Sleep Timer function (page 76).
- You cannot select the Play Timer and Timer Recording at the same time.

The remote does not function.

- Remove the obstacles between the remote and the unit.
- Move the remote closer to the unit.
- Point the remote at the unit's sensor.
- Replace the batteries (R6/size AA).
- Locate the unit away from the fluorescent light.

There is acoustic feedback.

- Reduce the volume.
- Move the microphone away from the speakers or change the direction of the microphone.

The color irregularity on a TV screen persists.

- Turn off the TV set once, then turn it on after 15 to 30 minutes. If the color irregularity still persists, place the speakers farther away from the TV set.

The sound from the component connected to the TV/SAT AUDIO IN L/R jacks is distorted.

- If "TV" appears in the display when you press TV/SAT, switch to "SAT" function (see "Listening to a connected TV or satellite tuner" on page 87).

Speakers

Sound comes from one channel or unbalanced left and right volume.

- Place the speakers as symmetrically as possible.
- Check that the speaker are connected securely and correctly.
- The source being played back is monaural.
- Turn off the X-ROUND mode (page 69) (MHC-GNV111D only).

The sound comes from the center speaker only.

- Depending on the disc, the sound may come from the center speaker only.

There is no sound from the subwoofer.

- Set the subwoofer level to the appropriate level.
- No sound is produced from the subwoofer when you play back a DVD VIDEO that does not have subwoofer output recorded.
- The software being played back has limited sound effects.
- Check that the subwoofer is connected securely and correctly.
- Make sure that the "SUBWOOFER" is set to "YES" (page 50).

There is no sound from the surround speaker.

- The software being played back has limited sound effects. Check the volume with the test tone (page 53).
- Check that the surround speakers are connected securely and correctly.
- Set the surround speaker level to the appropriate level.
- Make sure that the "SURROUND" is set to "SIDE" or "BEHIND" (page 50).

There is no sound from the center speaker.

- The software being played back has limited sound effects. Check the volume with the test tone (page 53).
- Check that the speaker is connected securely and correctly.
- Set the center speaker level to the appropriate level.
- Make sure that the "CENTER" is set to "YES" (page 50).

Sound lacks bass.

- Check that the speaker's + and - terminals are connected correctly.

Disc Player

The disc tray does not open and "LOCKED" appears in the display.

- Consult your nearest Sony dealer or local authorized Sony service facility.

The disc tray does not close.

- Load the disc correctly.
- Always close the disc tray by pressing  OPEN/CLOSE on the unit. Do not forcibly push the disc tray as this may cause a malfunction.

The disc does not eject.

- You cannot eject the disc during CD Synchro Recording. Press **■** to cancel the CD Synchro Recording, then press **▲** OPEN/CLOSE on the unit to eject the disc.
- Consult your nearest Sony dealer.

Playback does not start.

- Open the disc tray and check whether a disc is loaded.
- Wipe the disc clean (page 97).
- Reload the disc.
- Load the disc that this system can play back (page 6).
- Load the disc correctly.
- Load the disc on the disc tray with the label side facing up.
- Remove the disc and wipe away the moisture on the disc, then leave the system turned on for a few hours until the moisture evaporates.
- Press **▷** (or **◀▶** on the unit) to start playback.
- The region code on the DVD VIDEO does not match the system.
- Cancel the Custom Parental Control function (page 46).

The sound skips.

- Wipe the disc clean (page 97).
- Reload the disc.
- Move the unit to a place without vibration (e.g., on top of a stable stand).
- Move the speakers away from the unit, or placing them on separate stands. When you listen to a track with bass sounds at high volume, the speaker vibration may cause the sound to skip.

Playback does not start from the first track.

- The system is in Program Play or Shuffle Play mode. Cancel the Program Play or Shuffle Play function.
- Resume Play has been selected. Press **■** twice. Then, press **▷** (or **◀▶** on the unit) to start playback (page 18).
- The title, DVD or PBC menu automatically appears on the TV screen.

Playback starts automatically.

- The DVD VIDEO features an auto playback function.

Playback stops automatically.

- Some discs may contain an auto pause signal. While playing such a disc, the playback stops at auto pause signal.

You cannot perform some functions such as Stop, Lock Search, Slow-motion Play, Repeat Play, Shuffle Play or Program Play.

- Depending on the disc, you may not be able to do some of the operations above. Refer to the operating instructions supplied with the disc.

MP3 audio track cannot be played back.

- Recording was not performed according to the ISO 9660 Level 1, Level 2, or Joliet in expansion format.
- The MP3 audio track does not have the extension “.MP3”.
- The data is not stored in MP3 format.
- The MP3 audio tracks in format other than MPEG 1 Audio Layer 3 and MPEG 2 Audio Layer 3 cannot be played back.
- The system can playback to a depth of 8 folders only.
- The “MODE (MP3, JPEG)” setting has been set to “IMAGE (JPEG)” (page 30).
- The disc contains more than 200 albums.
- The album contains more than 600 tracks when the “MODE (MP3, JPEG)” is set to “AUDIO (MP3)”.
- The album contains more than 300 tracks when the “MODE (MP3, JPEG)” is set to “AUTO”.
- The DATA CD contains a DivX video file.
- This system cannot play back MP3 audio tracks recorded on DATA DVDs.

MP3 audio tracks take longer time to play back than others.

- After the system reads all tracks on the disc, playback may take more time than usual if:
 - the number of albums or tracks on the disc is very large.
 - the album and track organization structure is very complex.

DivX video file cannot be played back.

- Recording was not performed according to the ISO 9660 Level 1, Level 2, or Joliet in the expansion format.
- The DivX video file does not have the extension “.AVI” or “.DIVX.”
- DivX video files with a high width to length ratio cannot be played back.
- The data is not stored in DivX format.
- The disc contains more than 200 albums.
- The album contains more than 600 files.
- The system can play back to a depth of 8 folders only.

The JPEG image file cannot be played back.

- Recording was not performed according to the ISO 9660 Level 1, Level 2, or Joliet in the expansion format.
- The JPEG image file does not have the extension “.JPG” or “.JPEG”.
- The data is not stored in JPEG format.
- The image is larger than 3,072 (width) × 2,048 (height) in normal mode, or more than 3,300,000 pixels in Progressive JPEG mode.
- The “MODE (MP3, JPEG)” setting has been set to “AUDIO (MP3)” (page 30).
- The system can play back to a depth of 8 folders only.
- JPEG image files with a high width to length ratio cannot be played back.
- The disc contains more than 200 albums.
- The album contains more than 600 files when the “MODE (MP3, JPEG)” is set to “IMAGE (JPEG)”.
- The album contains more than 300 files when the “MODE (MP3, JPEG)” is set to “AUTO”.
- The DATA CD contains a DivX video file.
- This system cannot play back JPEG image files recorded on DATA DVDs.

The disc title, album title, track title, CD-TEXT and DVD-TEXT characters do not appear properly.

- Use a disc that conforms with ISO 9660 Level 1, Level 2, or Joliet in expansion format.
 - The character code that can be displayed by this system are as follows:
 - Upper cases (A to Z)
 - Lower cases (a to z)
 - Numbers (0 to 9)
 - Symbols (< > * +, - / [] \ _)
- Other characters may not be displayed correctly.

The surround effect is difficult to hear when you are playing a Dolby Digital or MPEG audio sound track.

- Make sure the sound field is set properly (page 67).
- Check the speaker connections and settings (pages 10 and 49).
- Depending on the DVD VIDEO, the output signal may not be the entire 5.1 channel. It may be monaural or stereo, even if the sound track is recorded in Dolby Digital or MPEG audio format.

The sound loses stereo effect when you playback an AUDIO CD, VIDEO CD, MP3 audio track, DivX video file or DVD VIDEO .

- Unplug the microphone or press KARAOKE MODE repeatedly until “” disappears from the display.
- Make sure the system is connected properly.

Picture

There is no picture.

- Press FUNCTION +/- repeatedly to select “DVD” (or press DVD on the unit).
- Check that the system is connected securely.
- The video cord is damaged. Replace it with a new one.
- Make sure you connect the unit to the video input jack of your TV (page 10).
- Make sure you turn on the TV and operate the TV correctly.
- Press PROGRESSIVE on the unit repeatedly to select “INTERLACE” if you connect your TV to the unit’s COMPONENT VIDEO OUT jacks and your TV cannot accept the progressive signal.
- You have set progressive format but your TV cannot accept the signal in progressive format. In this case, return the setting to interlace format (the default setting) (page 54).
- Even if your TV is compatible with progressive format (525p/625p) signals, the image may be affected when you set progressive format. In this case, return the setting to interlace format (the default setting) (page 54).
- Make sure you select the video input on the TV so that you can view the pictures from the system.
- Make sure you set the color system correctly, according to your TV color system.
- Make sure you connect the unit and your TV using only the supplied video cord.

Picture noise appears.

- Clean the disc.
- If video signal from your system has to go through your VCR to your TV, the copy-protection applied to some DVD VIDEO programs could affect picture quality. If you still experience problems after checking your connections, please try to connect your unit directly to your TV’s S Video input (page 11).
- Set the color system to match your TV (page 43).

The aspect ratio of the TV screen cannot be changed even though you can set “TV TYPE” under “SCREEN SETUP” in the Setup Menu when you play back a wide picture.

- The aspect ratio is fixed on your DVD VIDEO.
- If you connect the unit with the S Video cord, connect directly to the TV. Otherwise, you may not be able to change the aspect ratio.
- Depending on the TV, you may not be able to change the aspect ratio.

Messages do not appear on the TV screen in the language you want.

- Select the language you want for the on-screen display in “OSD” under “LANGUAGE SETUP” in the Setup Menu (page 40).

The language for the sound track cannot be changed.

- Multilingual tracks are not recorded on the DVD VIDEO being played back.
- The DVD VIDEO prohibits changing the language for the sound track.

The subtitles language cannot be changed.

- Multilingual subtitles are not recorded on the DVD VIDEO being played back.
- The DVD VIDEO prohibits changing the subtitles.

The subtitles cannot be turned off.

- The DVD VIDEO prohibits turning off subtitles.

The angles cannot be changed.

- Multi-angles are not recorded on the DVD VIDEO being played back.
- The DVD VIDEO prohibits changing the angles.

Tuner

There is severe hum or noise. (“TUNED” or “STEREO” flashes in the display)

- Set the proper band and frequency (page 59).
- Connect the antenna properly (page 10).
- Find a place and an orientation that provide good reception, then set up the antenna again. If you cannot obtain good reception, we recommend you connect a commercially available external antenna.
- The supplied FM lead antenna receives signals along its entire length, so make sure you extend it fully.
- Locate the antennas as far away from the speaker cords as possible.
- Try turning off surrounding electrical equipment.

A stereo FM program cannot be received in stereo.

- Press FM MODE repeatedly until “MONO” disappears from the display.

Tape deck

The tape does not record or playback, or there is a decrease in sound level.

- The tape heads are dirty (see “Cleaning the tape heads” on page 97).
- The record/playback heads are magnetized (see “Demagnetizing the tape heads” on page 97).

The tape does not erase completely.

- The record/playback heads are magnetized (see “Demagnetizing the tape heads” on page 97).

There is excessive wow or flutter, or the sound drops out.

- The capstans or pinch rollers are dirty (see “Cleaning the tape heads” on page 97).

Noise increases or the high frequencies are erased.

- The record/playback heads are magnetized (see “Demagnetizing the tape heads” on page 97).

The tape does not record.

- No tape is loaded. Load a tape.
- The tab has been removed from the tape. Cover the broken tab with adhesive tape (page 97).
- The tape has reeled to the end.

When you press ◀◀ or ▶▶ (or turn ◀◀ ▶▶) on the unit clockwise or counterclockwise, “Not in Use” flashes in the display.

- The system does not have AMS (Automatic Music Sensor) function. This is not a malfunction.

Optional components

There is no sound.

- Refer to General item “There is no sound.” (page 89) and check the condition of the system.
- Connect the component properly (page 85) while checking:
 - if the cords are connected properly.
 - if the cord plugs are firmly inserted all the way.
- Turn on the connected component.
- Refer to the operating instructions supplied with the connected component and start playing.

If the system still does not operate properly after performing the above measures or other troubles does not described above occur, reset the system as follows:

Use buttons on the unit for the operation.

- 1 Unplug the power cord.
- 2 Plug the power cord back in.
- 3 Press I/⏻ to turn on the system.
- 4 Press ■, ENTER and I/⏻ at the same time.

The system is reset to the factory settings except for DVD settings. You should set the settings you made, such as the preset stations, clock and timer.

To return the DVD setup to the default settings*, perform reset as follows:

- 1 Press  DISPLAY when playback is stopped.

The Control Menu appears in the on-screen display.

- 2 Press ↑ or ↓ repeatedly to select  (SETUP), then press ENTER.

- 3 Press ↑ or ↓ repeatedly to select "RESET", then press ENTER.

- 4 Press ↑ or ↓ repeatedly to select "YES", then press ENTER

It takes a few seconds to complete. Do not press I/⏻ when resetting the system.

* Except for Parental Control settings

Note

If you have connected an optional subwoofer, turn off the subwoofer before you reset the system.

Self-diagnosis Function

(When letters/numbers appear in the display)

When the self-diagnosis function is activated to prevent the system from malfunctioning, a 5-character service number (e.g., C 13 50) with a combination of a letter and 4 digits appears in the on-screen display and the front panel display. In this case, check the following table.

First 3 Characters of the service number	Cause and corrective action
C 13	This disc is dirty. <ul style="list-style-type: none"> • Clean the disc with a soft cloth (page 97).
C 31	The disc is not inserted correctly. <ul style="list-style-type: none"> • Restart the system, then re-insert the disc correctly.
E XX (XX is a number)	To prevent a malfunction, the system has performed the self-diagnosis function. <ul style="list-style-type: none"> • Contact your nearest Sony dealer or local authorized Sony service facility and give the 5-character service number. Example: E 61 10

Messages

One of the following messages may appear or flash in the front panel display during operation.

Disc

Cannot Play

- A disc that cannot be played back was inserted.
- A disc with unsupported region code was inserted.

No Disc

There is no disc on the disc tray.

Push STOP!

You have pressed the buttons those operations is possible only during playback is stopped.

Reading

The system is reading information of the disc. Some buttons are not available.

Please Wait

The system is doing initialization process.

Data Error

- The MP3 audio track, JPEG image file and DivX video file you want to played back is damaged.
- The MP3 audio track does not conform to MPEG 1 Audio Layer 3 format.
- The JPEG image file does not conform to DCF format.
- The DivX video file does not conform to a DivX Certified profiles.
- The MP3 audio track has the extension “.MP3” but it is not in MP3 format.
- The JPEG image file has the extension “.JPG” or “.JPEG” but it is not in JPEG format.
- The DivX video file has the extension “.AVI” or “.DIVX” but it is not in DivX format.

PASSWORD

Custom Parental Control or Parental Control is set.

Tape

No Tab

You cannot record the tape because the tab has been removed from the tape.

No Tape

There is no tape in the tape deck.

Timer

OFF TIME NG!

The on time and off time of Play Timer or Timer Recording is same.

Others

Not in Use

You have pressed a button those operation is not allowed or invalid at that time.

Invalid

You have pressed an invalid button.

Additional Information

Precautions

On operating voltage

Before operating the system, check that the operating voltage of the unit is identical with the voltage of your local power supply.

On safety

- The unit is not disconnected from the AC power source (mains) as long as it is connected to the wall outlet, even if the unit itself has been turned off.
- Unplug the unit from the wall outlet (mains) if it is not to be used for an extended period of time. To disconnect the power cord (mains lead), pull it out by the plug. Never pull the cord itself.
- Should any solid object or liquid fall into the unit, unplug the unit and have it checked by qualified personnel before operating it any further.
- AC power cord must be changed only at the qualified service shop.

On placement

- Do not place the unit in an inclined position.
- Do not place the unit in locations where it is:
 - extremely hot or cold
 - dusty or dirty
 - very humid
 - subject to vibrations
 - subject to direct sunlight.
- Use caution when placing the unit or speakers on surfaces that have been specially treated (with wax, oil, polish, etc.) as staining or discoloration of the surface may result.

On heat build-up

- Although the unit heats up during operation, this is not a malfunction.
- Place the unit in a location with adequate ventilation to prevent heat build-up in the unit.
- If you continuously use this unit at a large volume, the cabinet temperature of the top, side and bottom rises considerably. To avoid burning yourself, do not touch the cabinet.
- To prevent a malfunction, do not cover the ventilation hole for the cooling fan.

In case color irregularity is observed on a nearby TV screen

With the magnetically shielded type of speakers, the speakers can be installed near a TV set. However, color irregularity may still be observed on the TV screen depending on the type of your TV set.

If color irregularity is observed...

Turn off the TV set once, then turn it on after 15 to 30 minutes.

If color irregularity is observed again...

Place the speakers farther away from the TV set.

IMPORTANT NOTICE

Caution: This system is capable of holding a still video image or on-screen display image on your TV screen indefinitely. If you leave the still video image or on-screen display image displayed on your TV for an extended period of time you risk permanent damage to your TV screen. Projection TVs are especially susceptible to this.

On operation

- If the unit is brought directly from a cold to a warm location, or is placed in a very damp room, moisture may condense on the lens inside the unit. Should this occur, the system will not operate properly. Remove the disc and leave the system turned on for about an hour until the moisture evaporates.
- Before you move the unit, make sure that all discs are removed from the unit.

If you have any questions or problems concerning your system, please consult your nearest Sony dealer.

Notes on discs

- Before playing, clean the disc with a cleaning cloth. Wipe the disc from the center out.
- Do not use solvents such as benzene, thinner, commercially available cleaners or anti-static spray intended for vinyl LPs.
- Do not expose the disc to direct sunlight or heat sources such as hot air ducts nor leave it in a car parked in direct sunlight.
- Do not use discs encircled with a protection ring. This may cause a malfunction to the system.
- When using discs that have glue or similar tacky substance on the label side of the disc or that used a special ink when the label was printed, there is a chance that the disc or label may become attached to parts inside this unit. When this occurs, it may not be possible to remove the disc, and may also cause this system to malfunction. Be sure to check that the label side of the disc is not sticky before using.
The following types of disc should not be used:
 - rental or used discs with attached seals where the glue extends beyond the seal. The perimeter of the seal on the disc is tacky.
 - discs that have labels printed using a special ink that feels tacky when touched.
- Discs with non-standard shapes (e.g., heart, square, star) cannot be played back on this system. Attempting to do so may damage the system. Do not use such discs.

Cleaning the cabinet

Clean the cabinet, panel and controls with a soft cloth slightly moistened with mild detergent solution. Do not use any type of abrasive pad, scouring powder or solvent such as thinner, benzene or alcohol.

To save a tape permanently

To prevent a tape from being accidentally recorded over, break off the tape tab from side A or B as illustrated.

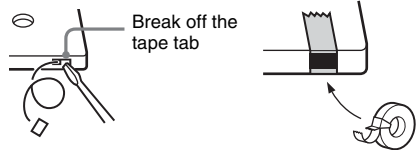

If you later want to reuse the tape for recording, cover the broken tab with adhesive tape.

Before placing a tape into the tape deck

Take up any slack in the tape deck. Otherwise, the tape may get entangled in the parts of the tape deck and become damaged.

When using a tape longer than 90 minutes

The tape is very elastic. Do not change the tape operations such as playback, stop and fast-winding etc. frequently. The tape may get entangled in the tape deck.

Cleaning the tape heads

Clean the tape heads after every 10 hours of use. Be sure to clean the tape heads before you start an important recording or after playing an old tape. Use a separately sold dry-type or wet-type cleaning tape. For details, refer to the instructions of the cleaning tape.

Demagnetizing the tape heads

Demagnetize the tape heads and the metal parts that have contact with the tape after every 20 to 30 hours of use with a separately sold demagnetizing tape. For details, refer to the instructions of the demagnetizing tape.

Specifications

Amplifier section

MHC-GNV111D

The following are measured at AC 120, 127, 220, 240V 50/60 Hz

DIN power output (rated)

Front speaker: 110 W + 110 W
(6 ohms at 1 kHz, DIN)
Center speaker: 50 W
(16 ohms at 1 kHz, DIN)
Surround speaker: 110 W + 110 W
(6 ohms at 1 kHz, DIN)

Continuous RMS power output (reference)

Front speaker: 160 W + 160 W
(6 ohms at 1 kHz, 10% THD)
Center speaker: 80 W
(16 ohms at 1 kHz, 10% THD)
Surround speaker: 160 W + 160 W
(6 ohms at 1 kHz, 10% THD)

MHC-GNV99D

The following are measured at AC 120, 127, 220, 240V 50/60 Hz

DIN power output (rated)

Front speaker: 130 W + 130 W
(6 ohms at 1 kHz, DIN)
Center speaker: 30 W
(8 ohms at 1 kHz, DIN)
Surround speaker: 30 W + 30 W
(8 ohms at 1 kHz, DIN)

Continuous RMS power output (reference)

Front speaker: 180 W + 180 W
(6 ohms at 1 kHz, 10% THD)
Center speaker: 50 W
(8 ohms at 1 kHz, 10% THD)
Surround speaker: 50 W + 50 W
(8 ohms at 1 kHz, 10% THD)

Inputs

VIDEO INPUT: VIDEO: 1 V_{p-p}, 75 ohms
(phono jacks) AUDIO L/R: Voltage 250 mV, impedance 47 kilohms
TV/SAT AUDIO IN L/R: voltage 250 mV/450 mV, impedance 47 kilohms
MIC 1/2: sensitivity 1 mV, impedance 10 kilohms
(phone jack)

Outputs

AUDIO OUT: Voltage 250 mV
(phono jacks) impedance 1 kilohm
VIDEO OUT: max. output level 1 V_{p-p}, unbalanced, Sync. negative load impedance 75 ohms
(phono jack)

COMPONENT VIDEO

OUT: Y: 1 V_{p-p}, 75 ohms
Pb/Cb: 0.7 V_{p-p}, 75 ohms
Pr/Cr: 0.7 V_{p-p}, 75 ohms
S VIDEO OUT: Y: 1 V_{p-p}, unbalanced, Sync. negative
(4-pin/mini-DIN jack) C: 0.286 V_{p-p} load impedance 75 ohms

PHONES:

(stereo mini jack) accepts headphones of 8 ohms or more

FRONT SPEAKER: Use only the supplied speakers

SURR SPEAKER: Use only the supplied speakers

CENTER SPEAKER: Use only the supplied speaker

SUBWOOFER OUT: Voltage 250 mV
(phono jack) impedance 1 kilohm

Disc player section

System Compact disc and digital audio and video system

Laser Semiconductor laser
(DVD: $\lambda = 650$ nm, CD: $\lambda = 790$ nm)
Emission duration: continuous

Frequency response DVD (PCM 48 kHz): 2 Hz – 22 kHz (± 1 dB)
CD: 2 Hz – 20 kHz (± 0.5 dB)

Video color system format

Latin American models: NTSC

Russian model: PAL

Other models: NTSC and PAL

Tape deck section

Recording system	4-track 2-channel stereo
Frequency response	50 – 13,000 Hz (± 3 dB), using Sony TYPE I tape
Wow and flutter	$\pm 0.15\%$ W.Peak (IEC) 0.1% W.RMS (NAB) $\pm 0.2\%$ W.Peak (DIN)

Tuner section

FM stereo, FM/AM superheterodyne tuner

FM tuner section

Tuning range	87.5 – 108.0 MHz (50 kHz step)
--------------	-----------------------------------

Antenna	FM lead antenna
Antenna terminals	75 ohms unbalanced
Intermediate frequency	10.7 MHz

AM tuner section

Tuning range	
Latin American models:	530 – 1,710 kHz (with the interval set at 10 kHz) 531 – 1,710 kHz (with the interval set at 9 kHz)

Saudi Arabian and Russian models:	531–1,602 kHz (with the interval set at 9 kHz)
-----------------------------------	--

Other models:	531 – 1,602 kHz (with the interval set at 9 kHz) 530 – 1,710 kHz (with the interval set at 10 kHz)
---------------	---

Antenna	AM loop antenna
Antenna terminals	External antenna terminal
Intermediate frequency	450 kHz

Speaker

Front speaker SS-GNV111D

Speaker system	2-way, 2-unit, bass-reflex type, magnetically shielded
Speaker units	
Subwoofer	20 cm, cone type
Tweeter	2.5 cm, horn type
Nominal impedance	6 ohms
Dimensions (w/h/d)	Approx. 280 x 416 x 305 mm
Mass	Approx. 7.1 kg net per speaker

Surround speaker SS-RSV111D

Speaker system	2-way, 2-units, bass-reflex type
Speaker units	
Woofer	20 cm, cone type
Tweeter	2.5 cm, horn type
Nominal impedance	6 ohms
Dimensions (w/h/d)	Approx. 280 x 416 x 305 mm
Mass	Approx. 6.5 kg net per speaker

Surround speaker SS-RSV99D

Speaker system	1-way, 2-unit, bass-reflex type
Speaker units	
Full range	8 cm, cone type
Nominal impedance	8 ohms
Dimensions (w/h/d)	Approx. 268 x 107 x 117 mm
Mass	Approx. 1.4 kg net per speaker

Center Speaker SS-CT111D

Speaker system	1-way, 2-unit, bass-reflex type, magnetically shielded
Speaker units	
Full range	8 cm, cone type
Nominal Impedance	16 ohms
Dimensions (w/h/d)	Approx. 268 x 107 x 117 mm
Mass	Approx. 1.6 kg net per speaker

Center Speaker SS-CT99D

Speaker system	1-way, 2-unit, bass-reflex type, magnetically shielded
Speaker units	
Full range	8 cm, cone type
Nominal Impedance	8 ohms
Dimensions (w/h/d)	Approx. 268 x 107 x 117 mm
Mass	Approx. 1.6 kg net per speaker

General

Power requirements

Australian model: 230 – 240 V AC, 50/60 Hz

Mexican model: 127 V AC, 60 Hz

Saudi Arabian models: 120 – 127 V, 220 V or
230 – 240 V AC, 50/60 Hz

Adjustable with voltage
selector

Other models: 120 V, 220 V or

230 – 240 V AC, 50/60 Hz

Adjustable with voltage
selector

Power consumption

MHC-GNV111D 380 W

MHC-GNV99D 285 W

Dimensions (w/h/d) (Approx.)

HCD-GNV111D 280 × 371 × 398.5 mm

HCD-GNV99D 280 × 360 × 398.5 mm

Mass (Approx.)

HCD-GNV111D 16.1 kg

HCD-GNV99D 15.2 kg

Supplied accessories: Remote Commander (1)
Batteries (2)
AM loop antenna (1)
FM lead antenna (1)
Video cord (1)
Front speaker pads (8)
Surround speaker pads (8)
Center speaker pads (4)
Speaker cords (8m) (2)
(MHC-GNV99D only)

Design and specifications are subject to change
without notice.

Language code list

The language spellings conform to the ISO 639:1988 (E/F) standard.

Code	Language	Code	Language	Code	Language	Code	Language
1027	Afar	1186	Scots Gaelic	1350	Malayalam	1513	Siswati
1028	Abkhazian	1194	Galician	1352	Mongolian	1514	Sesotho
1032	Afrikaans	1196	Guarani	1353	Moldavian	1515	Sundanese
1039	Amharic	1203	Gujarati	1356	Marathi	1516	Swedish
1044	Arabic	1209	Hausa	1357	Malay	1517	Swahili
1045	Assamese	1217	Hindi	1358	Maltese	1521	Tamil
1051	Aymara	1226	Croatian	1363	Burmese	1525	Telugu
1052	Azerbaijani	1229	Hungarian	1365	Nauru	1527	Tajik
1053	Bashkir	1233	Armenian	1369	Nepali	1528	Thai
1057	Byelorussian	1235	Interlingua	1376	Dutch	1529	Tigrinya
1059	Bulgarian	1239	Interlingue	1379	Norwegian	1531	Turkmen
1060	Bihari	1245	Inupiak	1393	Occitan	1532	Tagalog
1061	Bislama	1248	Indonesian	1403	(Afan) Oromo	1534	Setswana
1066	Bengali; Bangla	1253	Icelandic	1408	Oriya	1535	Tonga
1067	Tibetan	1254	Italian	1417	Punjabi	1538	Turkish
1070	Breton	1257	Hebrew	1428	Polish	1539	Tsonga
1079	Catalan	1261	Japanese	1435	Pashto; Pushto	1540	Tatar
1093	Corsican	1269	Yiddish	1436	Portuguese	1543	Twi
1097	Czech	1283	Javanese	1463	Quechua	1557	Ukrainian
1103	Welsh	1287	Georgian	1481	Rhaeto-Romance	1564	Urdu
1105	Danish	1297	Kazakh	1482	Kirundi	1572	Uzbek
1109	German	1298	Greenlandic	1483	Romanian	1581	Vietnamese
1130	Bhutani	1299	Cambodian	1489	Russian	1587	Volapük
1142	Greek	1300	Kannada	1491	Kinyarwanda	1613	Wolof
1144	English	1301	Korean	1495	Sanskrit	1632	Xhosa
1145	Esperanto	1305	Kashmiri	1498	Sindhi	1665	Yoruba
1149	Spanish	1307	Kurdish	1501	Sangho	1684	Chinese
1150	Estonian	1311	Kirghiz	1502	Serbo-Croatian	1697	Zulu
1151	Basque	1313	Latin	1503	Singhalese	1703	Not specified
1157	Persian	1326	Lingala	1505	Slovak		
1165	Finnish	1327	Laothian	1506	Slovenian		
1166	Fiji	1332	Lithuanian	1507	Samoa		
1171	Faroese	1334	Latvian; Lettish	1508	Shona		
1174	French	1345	Malagasy	1509	Somali		
1181	Frisian	1347	Maori	1511	Albanian		
1183	Irish	1349	Macedonian	1512	Serbian		

Glossary

Album

Section of a music or picture piece on a DATA CD containing MP3 audio tracks or JPEG image files.

Chapter

Subdivision of a title on a DVD VIDEO. A title is composed of several chapters.

DivX®

Digital video technology created by DivXNetworks, Inc. Videos encoded with DivX technology are among the highest quality with a relatively small file size.

Dolby Digital

This sound format for movie theaters is more advanced than Dolby Pro Logic Surround. In this format, the surround speakers output stereo sound with an expanded frequency range and a subwoofer channel for deep bass is independently provided. This format is also called "5.1" because the subwoofer channel is counted as 0.1 channel (since it functions only when a deep bass effect is needed). All six channels in this format are recorded separately to realize superior channel separation. Furthermore, since all the signals are processed digitally, less signal degradation occurs.

Dolby Pro Logic II

Dolby Pro Logic II creates five full-bandwidth output channels from two-channel sources. This is done using an advanced, high-purity matrix surround decoder that extracts the spatial properties of the original recording without adding any new sounds or tonal colorations.

Movie mode

The Movie mode is for use with stereo television shows and all the programmes encoded in Dolby Surround. The result is enhanced sound field directionality that approaches the quality of discrete 5.1-channel sound.

Music mode

The Music mode is for use with any stereo music recordings, and provides a wide and deep sound space.

Dolby Surround Pro Logic

As one method of decoding Dolby Surround, Dolby Surround Pro Logic produces four channels from two-channel sound. Compared with the former Dolby Surround system, Dolby Surround Pro Logic reproduces left-to-right panning more naturally and localizes sounds more precisely. To take full advantages of Dolby Surround Pro Logic, you should have one pair of surround speakers and a center speaker. The surround speakers output monaural sound.

DTS

Digital audio compression technology that the Digital Theater Systems, Inc. developed. This technology conforms to 5.1-channel surround. The rear channel is stereo and there is discrete subwoofer channel in this format. DTS provides the same 5.1 discrete channels of high quality digital audio. The good channel separation is realized because the all channel data is recorded discrete and processed in digital.

DVD VIDEO

A disc that contains up to 8 hours of moving pictures even though its diameter is the same as a AUDIO CD.

The data capacity of a single-layer and single-sided DVD VIDEO, at 4.7 GB (Giga Byte), is 7 times that of a AUDIO CD. Furthermore, the data capacity of a dual-layer and single-sided DVD VIDEO is 8.5 GB, a single-layer and double-sided DVD VIDEO 9.4 GB, and a dual-layer and double-sided DVD VIDEO 17 GB.

The picture data uses the MPEG 2 format, one of the worldwide standards for digital compression technology. The picture data is compressed to about 1/40 of its original size. The DVD VIDEO also uses variable rate coding technology that changes the data to be allocated according to the status of the picture.

The audio data is recorded in Dolby Digital as well as in PCM, allowing you to enjoy more realistic audio presence.

Furthermore, various advanced functions such as the multi-angle, multilingual, and Parental Control functions are provided with the DVD VIDEO.

DVD-RW

A DVD-RW is a recordable and rewritable disc that is the same size as a DVD VIDEO. The DVD-RW has two different modes: VR mode and Video mode. DVD-RWs created in Video mode have the same format as a DVD VIDEO, while discs created in VR (Video Recording) mode allow the contents to be programmed or edited.

DVD+RW

A DVD+RW (plus RW) is a recordable and rewritable disc. DVD+RWs use a recording format that is comparable to the DVD VIDEO format.

File

A JPEG image file recorded on a DATA CD or a DivX video file on a DATA CD/DATA DVD. ("File" is an exclusive definition for this system.) A single file consists of a single image or movie.

Film based software, Video based software

DVD VIDEOS can be classified as Film based or Video based software. Film based DVD VIDEOS contain the same images (24 frames per second) that are shown at movie theaters. Video based DVD VIDEOS, such as television dramas or sit-coms, displays images at 30 frames (or 60 fields) per second.

Index (AUDIO CD) / Video Index (VIDEO CD)

A number that divides a track into sections to easily locate the point you want on a VIDEO CD on an AUDIO CD. Depending on the disc, no indexes may be recorded.

Interlace format (Interlaced scanning)

The Interlace format is the NTSC standard method for displaying TV images at 30 frames per second. Each frame is scanned twice—alternately between the even numbered scanning lines and then odd numbered scanning lines, at 60 times per second.

Menu Playback

Playback using the menu screens recorded on VIDEO CDs with PBC functions. You can enjoy simple interactive software using the menu playback function.

Multi-angle function

Various angles, or viewpoints of the video camera, for a scene are recorded on some DVD VIDEOS.

Multilingual function

Several languages for the sound or subtitles in a picture are recorded on some DVD VIDEOS.

Multi Session

This is a recording method that enables adding of data using the Track-At-Once method. Conventional CDs begin at a CD control area called the Lead-in and end at an area called Lead-out. A Multi Session disc is a disc having multiple sessions, with each segment from Lead-in to Lead-out regarded as a single session.

Parental Control

A function of the DVD VIDEO to limit playback of the disc by the age of the users according to the limitation level in each country. The limitation varies from disc to disc; when it is activated, playback is completely prohibited, violent scenes are skipped or replaced with other scenes and so on.

Playback Control (PBC)

Signals encoded on VIDEO CDs (Version 2.0) to control playback. By using menu screens recorded on VIDEO CDs with PBC functions, you can enjoy playing simple interactive programs, programs with search functions, and so on.

This system conforms to Version 1.1 and Version 2.0 of VIDEO CD standards. You can enjoy two kinds of playback depending on the disc type.

VIDEO CDs without PBC functions (Version. 1.1 discs)

Enjoy video playback (moving pictures) as well as music.

VIDEO CDs with PBC functions (Version. 2.0 discs)

Play back interactive software using menu screens displayed on the TV screen (PBC Playback), in addition to the video playback function of Version 1.1 discs. Moreover, you can play high-resolution still pictures, if they are included on the disc.

Progressive format (sequential scanning)

Compared to the Interlace format that alternately shows every other line of an image (field) to create one frame, the Progressive format shows the entire image at once as a single frame. This means that while the Interface format can show 25/30 frames (50/60 fields) in one second, the Progressive format can show 50/60 frames in one second. The overall picture quality increases and still images, text, and horizontal lines appear sharper. This system is compatible with 525/625 progressive format.

Region Code

This system is used to protect copyrights. A region code is allocated on each DVD system or DVD VIDEO according to the sales region. Each region code is shown on the unit as well as on the disc packaging. The system can play back the discs that match its region code. The system can also play back discs with the “” mark. Even when the region code is not shown on the DVD VIDEO, the region limit may still be activated.

Scene

On a VIDEO CD with PBC functions, the menu screens, moving pictures and still pictures are divided into sections called “scenes”. Each scene is assigned a scene number enabling you to locate the scene you want.

Title

The longest section of a picture or a music piece on a DVD VIDEO; a movie, etc., for a picture piece on video software; or an album, etc., for a music piece on audio software. Each title is assigned a title number enabling you to locate the title you want.

Track

Sections of a picture or a music piece on an AUDIO CD or VIDEO CD. Each track is assigned a track number enabling you to locate the track you want.

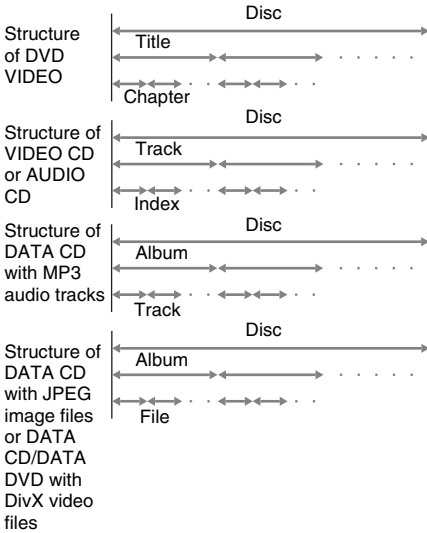

VIDEO CD

A compact disc that contains moving pictures. The picture data uses the MPEG 1 format, one of the worldwide standards for digital compression technology. The picture data is compressed to about 1/140 of its original size. Consequently, a 12 cm VIDEO CD can contain up to 74 minutes of moving pictures.

VIDEO CDs also contain compact audio data. Sound outside the range of human hearing are compressed while the sounds we can hear are not compressed. VIDEO CDs can hold 6 times the audio information of conventional AUDIO CDs.

There are 2 versions of VIDEO CDs.

- Version 1.1: You can play back only moving pictures and sounds.
- Version 2.0: You can play back high-resolution still pictures and enjoy PBC functions.

This system conforms to both versions.

List of button locations and reference pages

How to use page 106 to 108

Use this page to find the location of buttons and other parts of the unit and remote that are mentioned in the text.

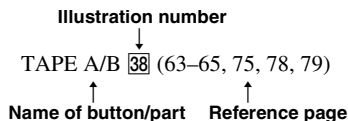

Unit

ALPHABETICAL ORDER

A - D

AMP MENU **34** (80)
 AUTO/MANUAL* **2** (69)
 CD SYNC **13** (63, 64)
 Deck A **32** (62, 63)
 Deck B **22** (62, 63, 64, 75)
 DIRECTION **18** (62, 63)
 DISC 1 ~ 3 **7** (17, 19, 22)
 Disc tray **9** (12, 15, 16, 19, 22, 27-30, 32, 33, 71, 72, 74, 90, 91, 95)
 DISPLAY **44** (79, 81)
 Display **45**
 DVD **40** (12, 14, 17, 54, 63, 64, 70, 79, 92)

E - L

ECHO LEVEL **24** (70, 71)
 ENTER **21** (14, 15, 18-24, 28, 30, 31, 36, 37, 40, 42, 44-50, 52, 60, 66, 71-74, 76-78, 80, 94)
 EQ BAND **11** (66)
 EX-CHANGE/DISC SKIP **6** (16, 17)
 GROOVE **37** (65)
 ILLUMINATION **43** (81)
 IR Receptor **41**

M - R

MASTER VOLUME **8** (52, 76, 81, 89)
 MIC 1 (jack) **27** (70, 75, 89)
 MIC 2 (jack) **26** (70, 75, 89)
 MIC LEVEL **25** (70, 89)
 OPERATION DIAL **30** (66-68, 80)
 PHONES (jack) **29** (69, 70, 89)
 Power illuminator **23** (81)
 PRESET +/- **17** (59-61)
 PROGRESSIVE **10** (44, 54, 86, 92)
 REC PAUSE/START **16** (63-65, 75)

S - Z

SOUND FIELD **46** (67-70, 88)
 SOUND FLASH **31** (68)
 SPEAKERS* **1** (70)
 TAPE A/B **38** (63-65, 75, 78, 79)
 Tape lid **22** **32** (62)
 TUNER/BAND **39** (59, 60, 64, 79)
 TUNING +/- **19** (59, 61)
 TV/SAT **36** (64, 79, 87, 90)
 VIDEO INPUT (jacks) **28** (86, 98)
 VIDEO **35** (64, 79, 87)
 X-ROUND buttons* **3** (69)
 WAVE/FADER/BALANCE
 RANDOM/TWISTER
 X-ROUND JOG* **4** (69)
 X-ROUND OFF* **1** (69)

SYMBOLS

I/☹ (power) **42** (12, 14, 60, 77, 78, 87, 89, 94)
 ▲ OPEN/CLOSE **5** (12, 15-17, 90, 91)
 ◀▶ (play) **12** (17, 18, 22, 24, 26, 27, 29, 30, 32-34, 43, 48, 62-65, 75, 78, 89, 91)
 ◀◀▶▶ (go backward/forward) **17** (17, 24, 28, 65, 76-78, 93)
 ◀◀▶▶ (rewind/fast forward) **19** (34, 63)
 ◀◀ SLOW ▶▶ **19** (34)
 || (pause) **14** (11, 17, 63)
 ■ (stop) **15** (17, 18, 24, 28, 30, 60, 63-65, 75, 78, 91, 94)
 ▲ A (Eject A) **33** (62, 63)
 B ▲ (Eject B) **20** (62, 63)

* MHC-GNV111D only

Top Panel

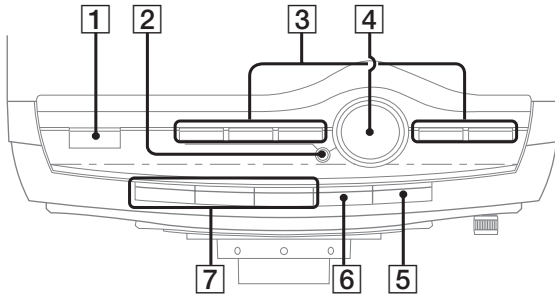

Front Panel

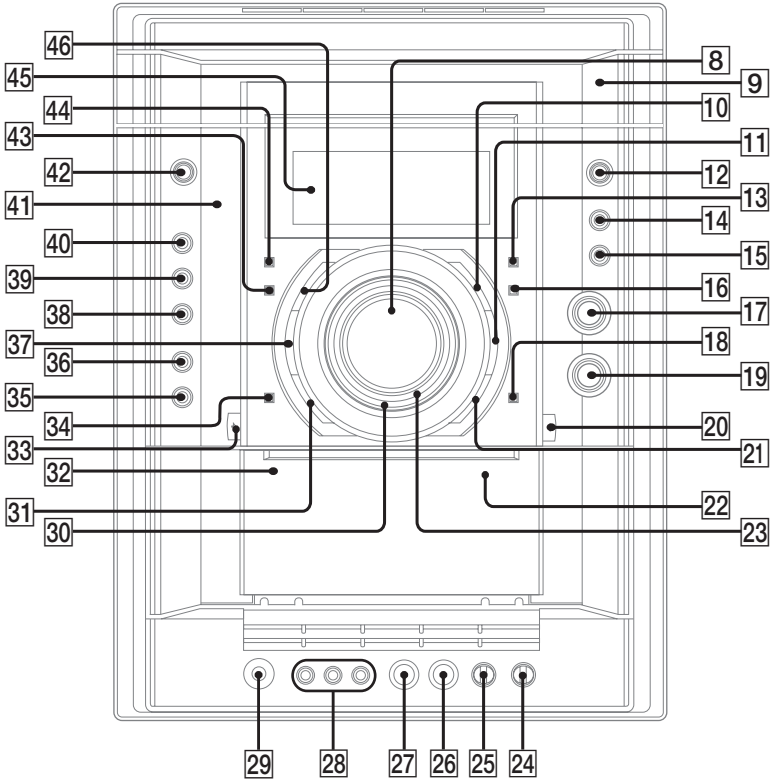

Remote control

ALPHABETICAL ORDER

A - L

- ADVANCE **▶▶** **23** (17)
 ALBUM +/- **11** (17, 53)
 ANGLE **10** (42)
 AUDIO **8** (38, 39, 70, 88)
 CLEAR **27** (19, 20, 22, 29, 36, 50)
 DISC SKIP **3** (17, 19, 22)
 DISPLAY **32** (79, 81)
 ENTER **25** (14, 15, 18–24, 28, 30, 31, 36, 37, 40, 42, 44–50, 52, 60, 71–74, 76–78)
 FM MODE **7** (61, 93)
 FUNCTION +/- **4** (14, 17, 54, 59, 61, 62, 70, 78, 87, 92)
 KARAOKE MODE **30** (71, 88, 92)
 KARAOKE PON **29** (71)
 KEY CONTROL #/b **31** (72)

M - S

- MENU **12** (23, 26, 28, 30, 32, 59, 60)
 Numeric Buttons¹⁾²⁾ **28** (12, 18, 23, 24, 36, 41, 45–48, 53, 54)
 PICTURE NAVI **6** (29, 37)
 PRESET + **15** (59–61)
 PRESET - **22** (59–61)
 REPEAT **7** (21)
 REPLAY **◀•** **23** (17)
 SLEEP **34** (53, 76)
 SLOW **▶▶** **16** (34)
 SLOW **◀◀** **21** (34)
 SOUND FIELD **5** (67, 68, 88)
 STEP II **▶▶** **23** (34)
 SUBTITLE **9** (39)

T - Z

- THEATRE SYNC **1** (54)
 TIMER MENU **35** (14, 76–78)
 TIME/TEXT **33** (81–83)
 TOP MENU **26** (23)
 TUNING + **16** (59, 61)
 TUNING - **21** (59, 61)
 TV²⁾ **19** (12)
 TV CH +²⁾ **15** (12)
 TV CH -²⁾ **22** (12)
 TV/VIDEO²⁾ **34** (12)
 TV VOL +/-¹⁾²⁾ **13** (12)
 TV I/⏻²⁾ **2** (12)
 VOLUME +/-¹⁾ **13** (52, 76, 81, 89)

NUMBERS AND SYMBOLS

- I/⏻ (power) **2** (12, 77, 78, 89)
 ■ (stop) **17** (17, 18, 24, 27, 28, 30, 32, 60, 63, 78)
 || (pause) **18** (17, 63)
 ▷¹⁾ (play) **20** (17, 18, 22, 24, 26, 27, 29, 30, 32–34, 43, 48, 62, 63, 78, 89, 91)
 ▶▶ (go forward) **15** (17, 24, 28, 54, 93)
 ◀◀ (go backward) **22** (17, 24, 28, 93)
 ▶▶ (fast forward) **16** (34, 63)
 ◀◀ (rewind) **21** (34, 63)
 ⬆️/⬅️/➡️/⬆️ **25** (14, 15, 19–23, 27–32, 35–37, 40, 42, 44–50, 52, 67, 71–74, 76–78, 94)
 10/0²⁾ **28**
 -/+²⁾ **27** (12)
 ⏪ RETURN **24** (24, 28, 33, 37)
 ☹️ DISPLAY **14** (15, 19–23, 30, 31, 35–37, 40, 42, 44–46, 48, 49, 52, 56, 57, 71–74, 84, 94)
 ◀|| STEP **23** (34)

- 1) The numeric button 5, TV VOL +, VOLUME + and ▷ buttons have a tactile dot. Use the tactile dot as a reference when operating the system.
 2) This button is used to operate a Sony TV. For details, see “Operating a Sony TV” on page 12.

