

### MG12450WB-BN2MM

RoHS

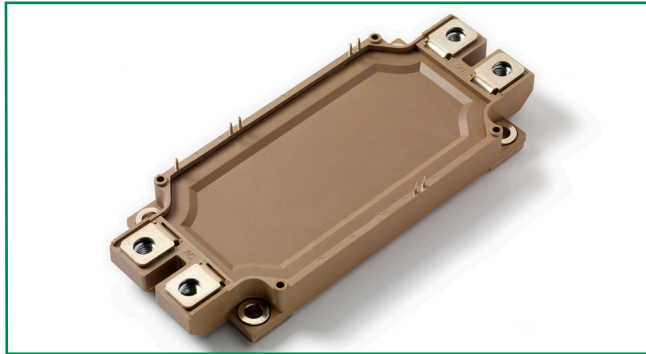

#### Features

- IGBT<sup>3</sup> CHIP(Trench+Field Stop technology)
- Low saturation voltage and positive temperature coefficient
- Fast switching and short tail current
- Free wheeling diodes with fast and soft reverse recovery
- Temperature sense included

#### Applications

- AC motor control
- Motion/servo control
- Photovoltaic/Fuel cell
- Inverter and power supplies

#### Module Characteristics ( $T_J = 25^\circ\text{C}$ , unless otherwise specified)

Symbol	Parameters	Test Conditions	Min	Typ	Max	Unit
$T_{J\max}$	Max. Junction Temperature				150	$^\circ\text{C}$
$T_{J\text{op}}$	Operating Temperature		-40		125	$^\circ\text{C}$
$T_{\text{stg}}$	Storage Temperature		-40		125	$^\circ\text{C}$
$V_{\text{isol}}$	Insulation Test Voltage	AC, t=1min		3000		V
CTI	Comparative Tracking Index		210			
Torque	Module-to-Sink	Recommended (M5)	2.5		5	N·m
Torque	Module Electrodes	Recommended (M6)	3		5	N·m
Weight				350		g

#### Absolute Maximum Ratings ( $T_J = 25^\circ\text{C}$ , unless otherwise specified)

Symbol	Parameters	Test Conditions	Values	Unit
<b>IGBT</b>				
$V_{\text{CES}}$	Collector - Emitter Voltage	$T_J = 25^\circ\text{C}$	1200	V
$V_{\text{GES}}$	Gate - Emitter Voltage		$\pm 20$	V
$I_C$	DC Collector Current	$T_C = 25^\circ\text{C}$	600	A
		$T_C = 80^\circ\text{C}$	450	A
$I_{\text{CM}}$	Repetitive Peak Collector Current	$t_p = 1\text{ms}$	900	A
$P_{\text{tot}}$	Power Dissipation Per IGBT		1950	W
<b>Diode</b>				
$V_{\text{RRM}}$	Repetitive Reverse Voltage	$T_J = 25^\circ\text{C}$	1200	V
$I_{\text{F(AV)}}$	Average Forward Current	$T_C = 25^\circ\text{C}$	450	A
		$T_C = 80^\circ\text{C}$	350	A
$I_{\text{FRM}}$	Repetitive Peak Forward Current	$t_p = 1\text{ms}$	900	A
$I^2t$		$T_J = 125^\circ\text{C}$ , $t = 10\text{ms}$ , $V_R = 0\text{V}$	34000	$\text{A}^2\text{s}$

### Electrical and Thermal Specifications ( $T_J = 25^\circ\text{C}$ , unless otherwise specified)

Symbol	Parameters	Test Conditions	Min	Typ	Max	Unit
<b>IGBT</b>						
$V_{GE(th)}$	Gate - Emitter Threshold Voltage	$V_{CE}=V_{GE}, I_C=18\text{mA}$	5.0	5.8	6.5	V
$V_{CE(sat)}$	Collector - Emitter Saturation Voltage	$I_C=450\text{A}, V_{GE}=15\text{V}, T_J=25^\circ\text{C}$		1.7		V
	Saturation Voltage	$I_C=450\text{A}, V_{GE}=15\text{V}, T_J=125^\circ\text{C}$		2.0		V
$I_{ICES}$	Collector Leakage Current	$V_{CE}=1200\text{V}, V_{GE}=0\text{V}, T_J=25^\circ\text{C}$			1	mA
		$V_{CE}=1200\text{V}, V_{GE}=0\text{V}, T_J=125^\circ\text{C}$			5	mA
$I_{GES}$	Gate Leakage Current	$V_{CE}=0\text{V}, V_{GE}=\pm 15\text{V}, T_J=125^\circ\text{C}$	-400		400	nA
$R_{Gint}$	Integrated Gate Resistor			1.7		$\Omega$
$Q_{ge}$	Gate Charge	$V_{CE}=600\text{V}, I_C=450\text{A}, V_{GE}=\pm 15\text{V}$		4.3		$\mu\text{C}$
$C_{ies}$	Input Capacitance	$V_{CE}=25\text{V}, V_{GE}=0\text{V}, f=1\text{MHz}$		32		nF
$C_{res}$	Reverse Transfer Capacitance				1.5	
$t_{d(on)}$	Turn - on Delay Time	$V_{CC}=600\text{V}$ $I_C=450\text{A}$ $R_G=1.6\Omega$ $V_{GE}=\pm 15\text{V}$ Inductive Load	$T_J=25^\circ\text{C}$		160	ns
			$T_J=125^\circ\text{C}$		170	ns
$t_r$	Rise Time		$T_J=25^\circ\text{C}$		45	ns
			$T_J=125^\circ\text{C}$		50	ns
$t_{d(off)}$	Turn - off Delay Time		$T_J=25^\circ\text{C}$		460	ns
			$T_J=125^\circ\text{C}$		530	ns
$t_f$	Fall Time		$T_J=25^\circ\text{C}$		100	ns
			$T_J=125^\circ\text{C}$		150	ns
$E_{on}$	Turn - on Energy		$T_J=25^\circ\text{C}$		20	mJ
			$T_J=125^\circ\text{C}$		31	mJ
$E_{off}$	Turn - off Energy	$T_J=25^\circ\text{C}$		33	mJ	
		$T_J=125^\circ\text{C}$		55	mJ	
$I_{SC}$	Short Circuit Current	$t_{psc} \leq 10\mu\text{s}, V_{GE}=15\text{V}, T_J=125^\circ\text{C}, V_{CC}=900\text{V}$		1800		A
$R_{thJC}$	Junction-to-Case Thermal Resistance (Per IGBT)				0.064	K/W
<b>Diode</b>						
$V_F$	Forward Voltage	$I_F=450\text{A}, V_{GE}=0\text{V}, T_J=25^\circ\text{C}$		1.65		V
		$I_F=450\text{A}, V_{GE}=0\text{V}, T_J=125^\circ\text{C}$		1.6		V
$t_{RR}$	Reverse Recovery Time	$I_F=450\text{A}, V_R=600\text{V}$ $di_F/dt=-7200\text{A}/\mu\text{s}$ $T_J=125^\circ\text{C}$		255		ns
$I_{RRM}$	Max. Reverse Recovery Current			385		A
$E_{rec}$	Reverse Recovery Energy			38		mJ
$R_{thJCD}$	Junction-to-Case Thermal Resistance (Per Diode)				0.12	K/W

### NTC Characteristics ( $T_J = 25^\circ\text{C}$ , unless otherwise specified)

Symbol	Parameters	Test Conditions	Min	Typ	Max	Unit
$R_{25}$	Resistance	$T_c=25^\circ\text{C}$		5		K $\Omega$
$B_{25/50}$				3375		K

**Figure 1: Typical Output Characteristics for IGBT Inverter**

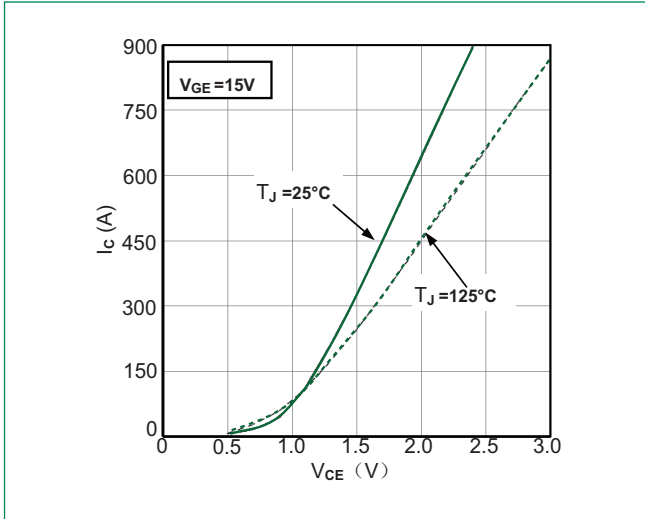

**Figure 2: Typical Output Characteristics for IGBT Inverter**

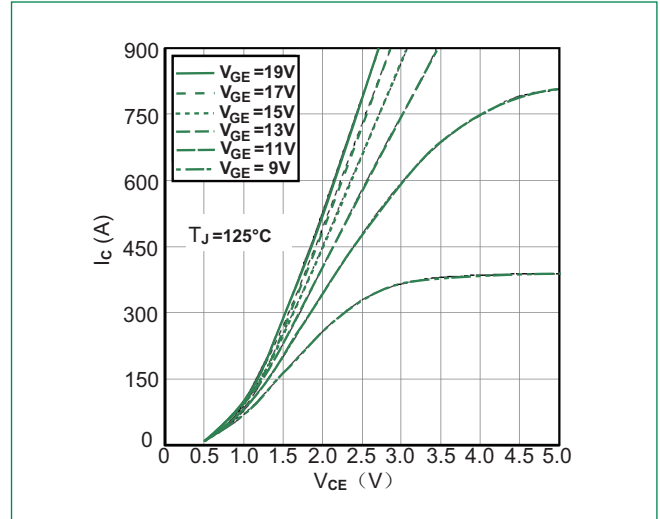

**Figure 3: Typical Transfer Characteristics for IGBT Inverter**

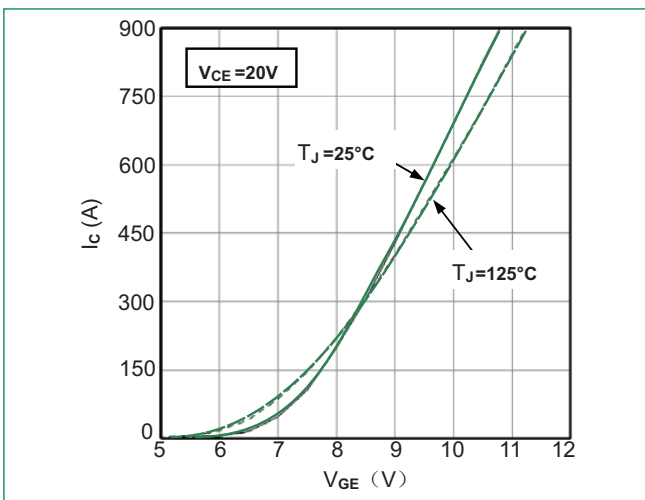

**Figure 4: Switching Energy vs. Gate Resistor for IGBT Inverter**

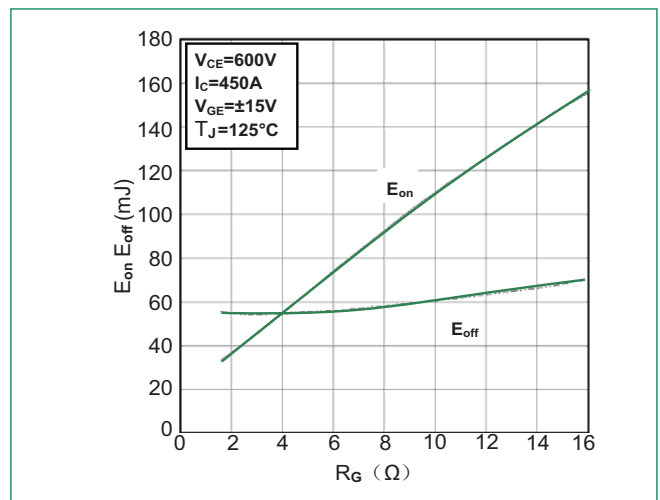

**Figure 5: Switching Energy vs. Collector Current for IGBT Inverter**

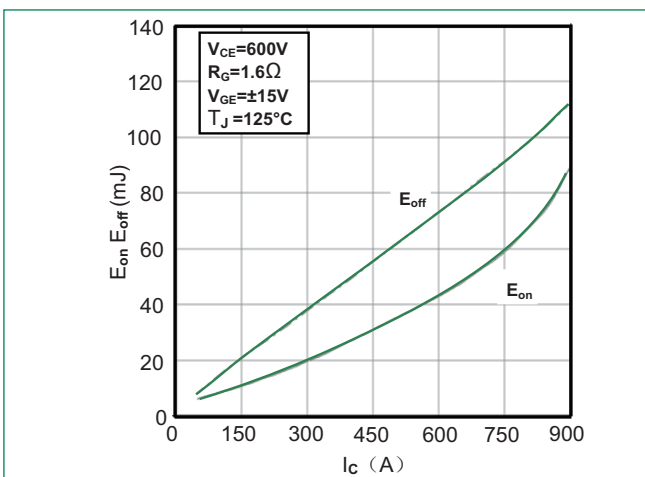

**Figure 6: Reverse Biased Safe Operating Area for IGBT Inverter**

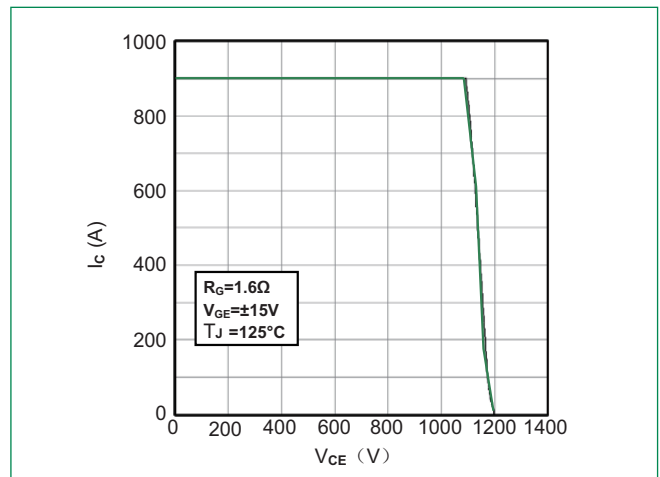

**Figure 7: Diode Forward Characteristics for Diode Inverter**

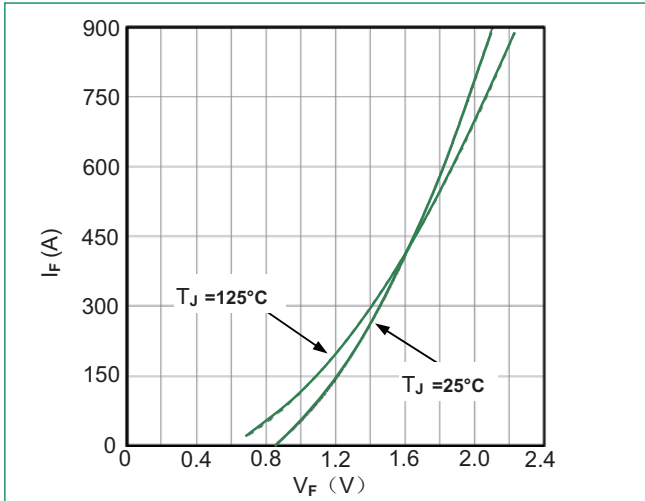

**Figure 8: Switching Energy vs. Gate Resistort for Diode Inverter**

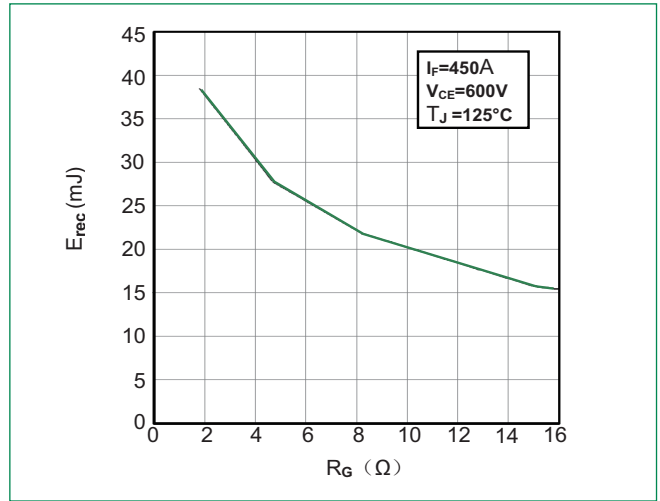

**Figure 9: Transient Thermal Impedance of Diode and IGBT Inverter**

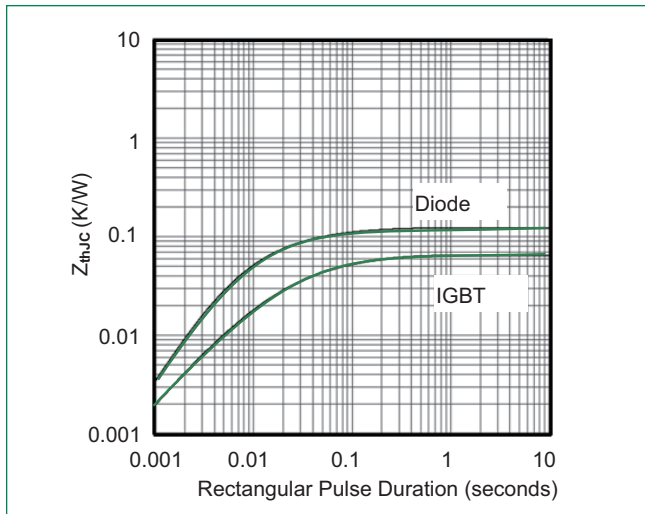

**Figure 10: NTC Characteristics**

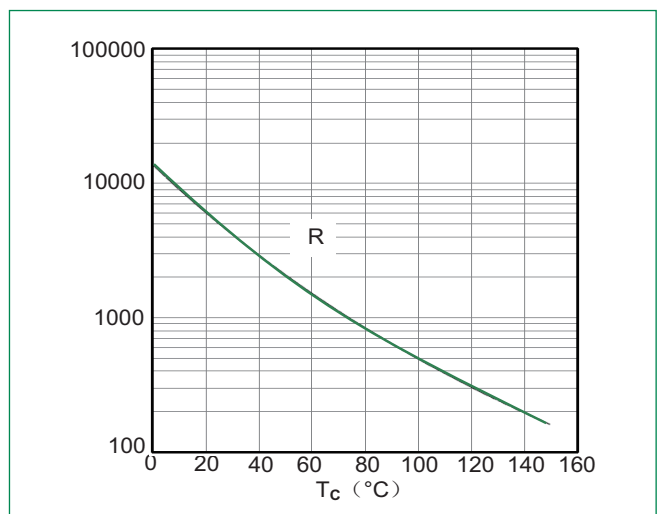

### Circuit Diagram



### Dimensions-Package WB

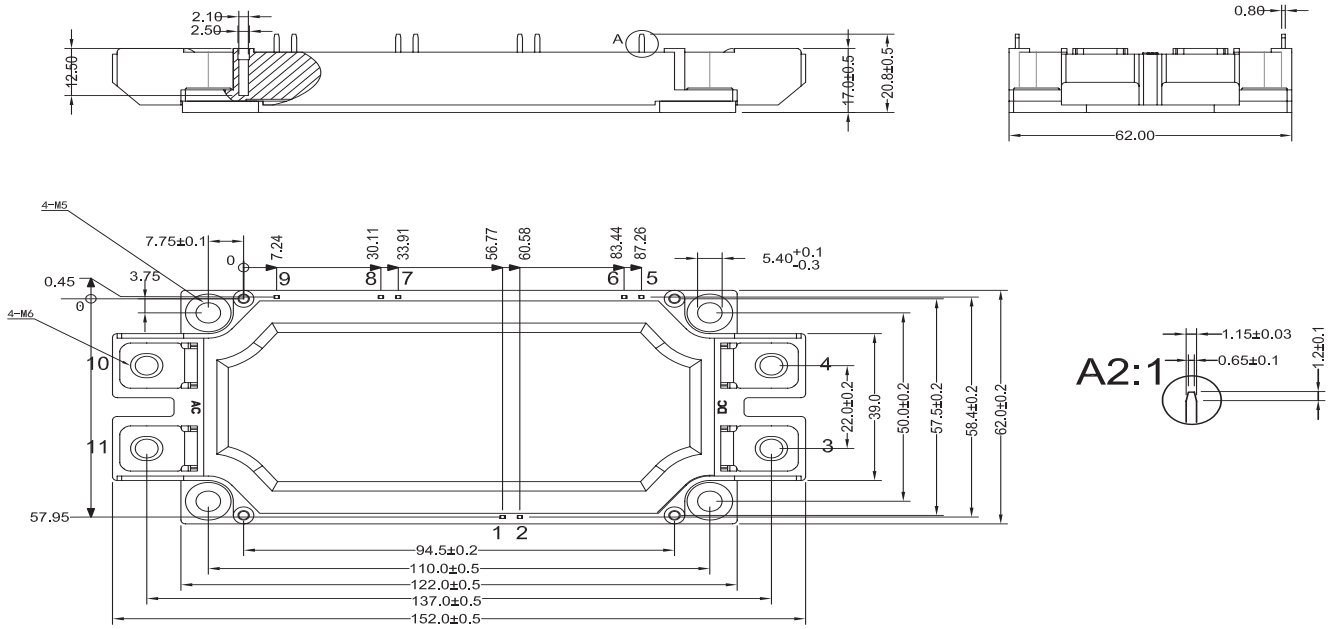

The foot pins are in gold / nickel coating

### Packing Options

Part Number	Marking	Weight	Packing Mode	M.O.Q
MG12450WB-BN2MM	MG12450WB-BN2MM	350g	Bulk Pack	60

### Part Numbering System

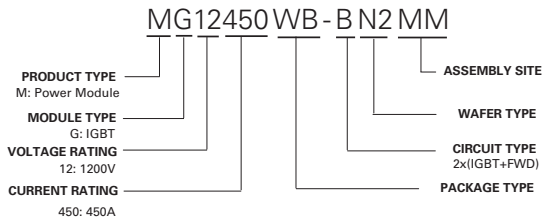

### Part Marking System

