

High Power Diode Modules

$I_{FRMS} = 2 \times 520 \text{ A}$
 $I_{FAVM} = 2 \times 310 \text{ A}$
 $V_{RRM} = 1200\text{-}2200 \text{ V}$

V_{RSM} V	V_{RRM} V	Type
1300	1200	MDD 312-12N1
1500	1400	MDD 312-14N1
1700	1600	MDD 312-16N1
1900	1800	MDD 312-18N1
2100	2000	MDD 312-20N1
2300	2200	MDD 312-22N1

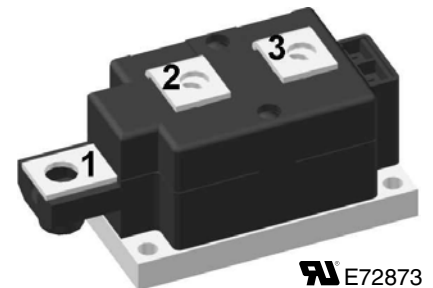
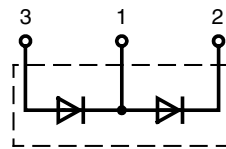

Symbol	Conditions	Maximum Ratings
I_{FRMS}	$T_{VJ} = T_{VJM}$	$T_C = 25^\circ\text{C}$ 520 A
I_{FAVM}	180° sine	$T_C = 100^\circ\text{C}$ 310 A
I_{FSM}	$T_{VJ} = 45^\circ\text{C};$ $V_R = 0$	$t = 10 \text{ ms}$ (50 Hz) 10500 A
		$t = 8.3 \text{ ms}$ (60 Hz) 11200 A
I^2t	$T_{VJ} = 45^\circ\text{C};$ $V_R = 0$	$t = 10 \text{ ms}$ (50 Hz) 551 000 A ² s
		$t = 8.3 \text{ ms}$ (60 Hz) 527 000 A ² s
I^2t	$T_{VJ} = T_{VJM};$ $V_R = 0$	$t = 10 \text{ ms}$ (50 Hz) 423 000 A ² s
		$t = 8.3 \text{ ms}$ (60 Hz) 403 000 A ² s
T_{VJ}		-40...+150 °C
T_{VJM}		150 °C
T_{stg}		-40...+125 °C
V_{ISOL}	50/60 Hz, RMS $t = 1 \text{ min}$ $I_{ISOL} \leq 1 \text{ mA}$ $t = 1 \text{ s}$	3000 V~
		3600 V~
M_d	Mounting torque (M6)	4.5 - 7 Nm
	Terminal connection torque (M8)	11-13 Nm
Weight	Typical including screws	750 g

Features

- International standard package
- Direct Copper Bonded Al₂O₃ ceramic with copper base plate
- Planar passivated chips
- Isolation voltage 3600 V~
- UL registered

Applications

- Supplies for DC power equipment
- DC supply for PWM inverter
- Field supply for DC motors
- Battery DC power supplies

Advantages

- Simple mounting
- Improved temperature & power cycling
- Reduced protection circuits

Symbol	Conditions	Characteristics Values
I_{RRM}	$V_R = V_{RRM}$	$T_{VJ} = T_{VJM}$ 30 mA
V_F	$I_F = 600 \text{ A};$	$T_{VJ} = 25^\circ\text{C}$ 1.32 V
V_{TO}	For power-loss calculations only 0.8 V	
r_t	$T_{VJ} = T_{VJM}$	0.6 mΩ
R_{thJC}	per diode; DC current	0.12 K/W
	per module	0.06 K/W
R_{thJK}	per diode; DC current	0.16 K/W
	per module	0.08 K/W
Q_s	$I_F = 400 \text{ A}; -di/dt = 50 \text{ A}/\mu\text{s}; T_{VJ} = 125^\circ\text{C}$	700 μC
I_{RM}		260 A
d_s	Creeping distance on surface	12.7 mm
d_A	Creepage distance in air	9.6 mm
a	Maximum allowable acceleration	50 m/s ²

Data according to IEC 60747 and refer to a single diode unless otherwise stated.

Dimensions in mm (1 mm = 0.0394")

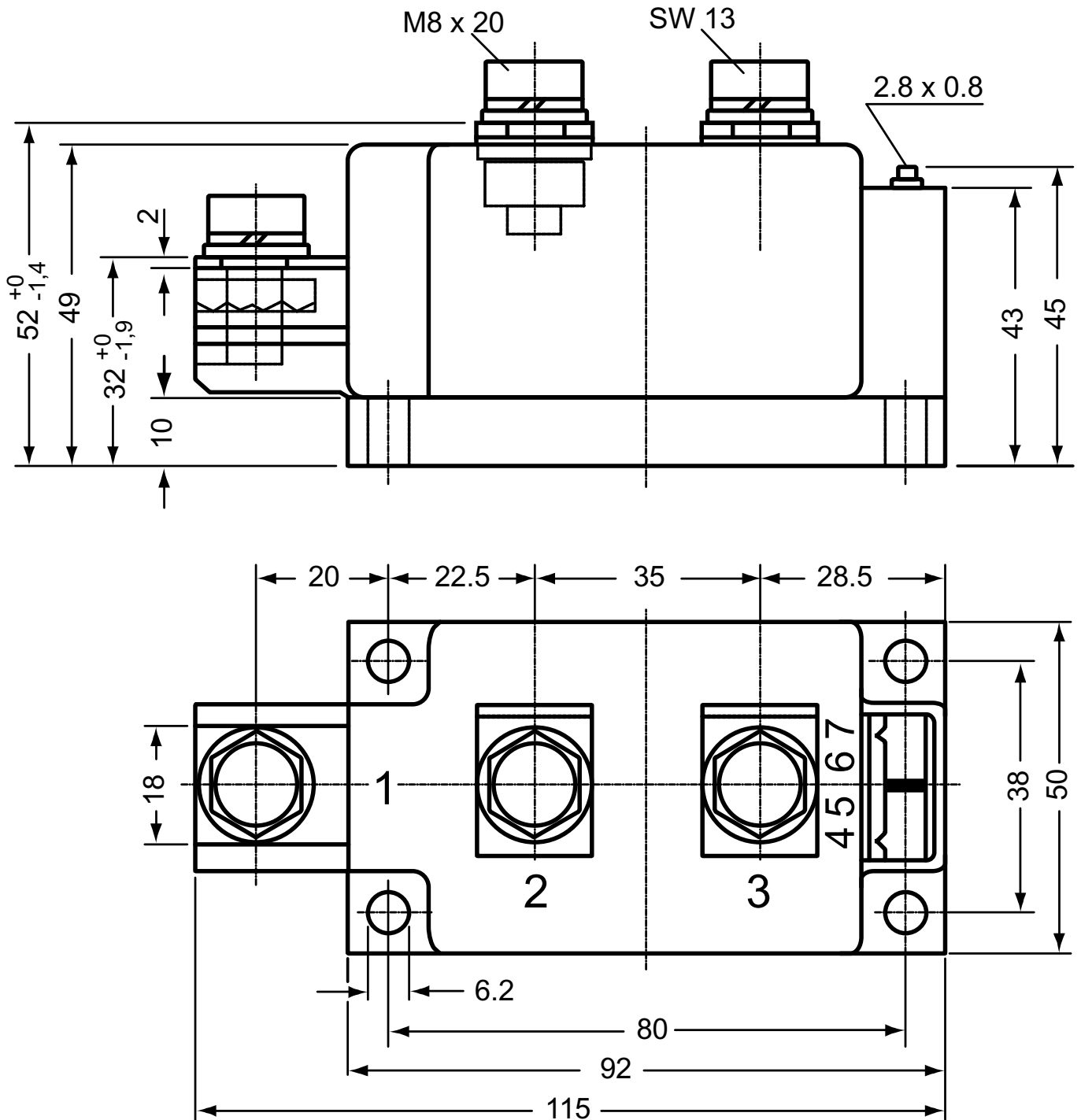

Optional accessories for modules

Keyed gate/cathode twin plugs with wire length = 350 mm, gate = white, cathode = red

Type ZY 180L (L = Left for pin pair 4/5)

Type ZY 180R (R = Right for pin pair 6/7) } UL 758, style 3751

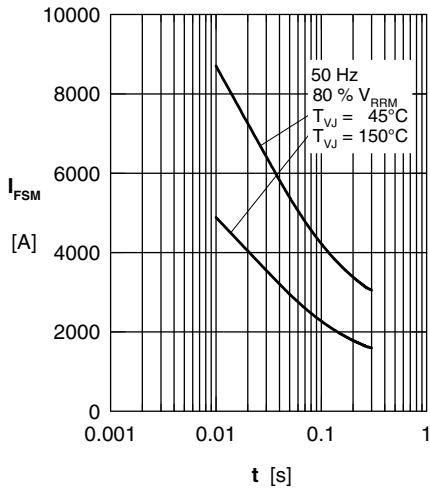

Fig. 1 Surge overload current I_{FSM} : Crest value, t : duration

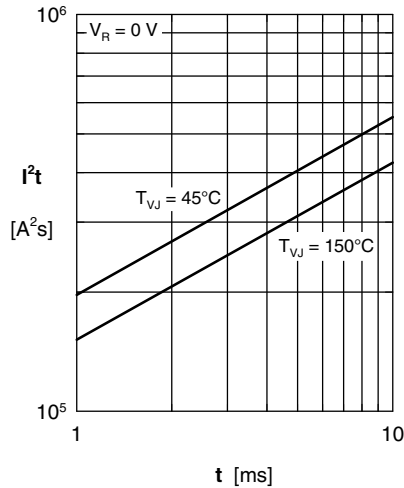

Fig. 2 I^2t versus time (1-10 ms)

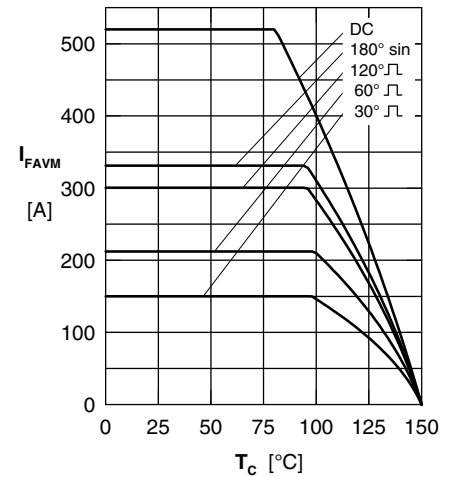

Fig. 3 Maximum forward current at case temperature

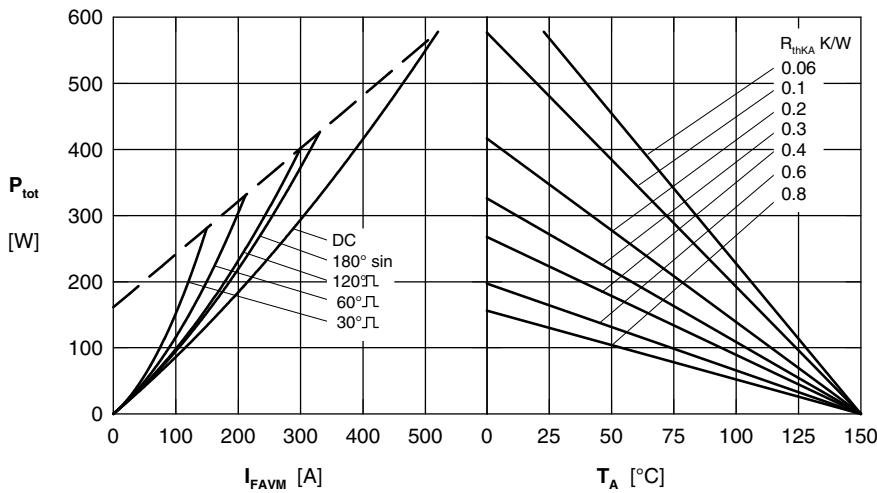

Fig. 4 Power dissipation vs. forward current & ambient temperature (per diode)

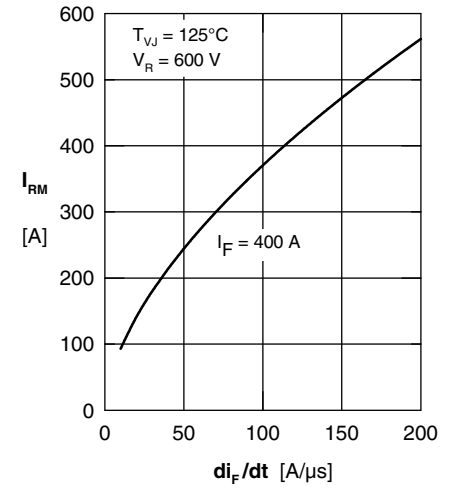

Fig. 5 Typ. peak reverse current

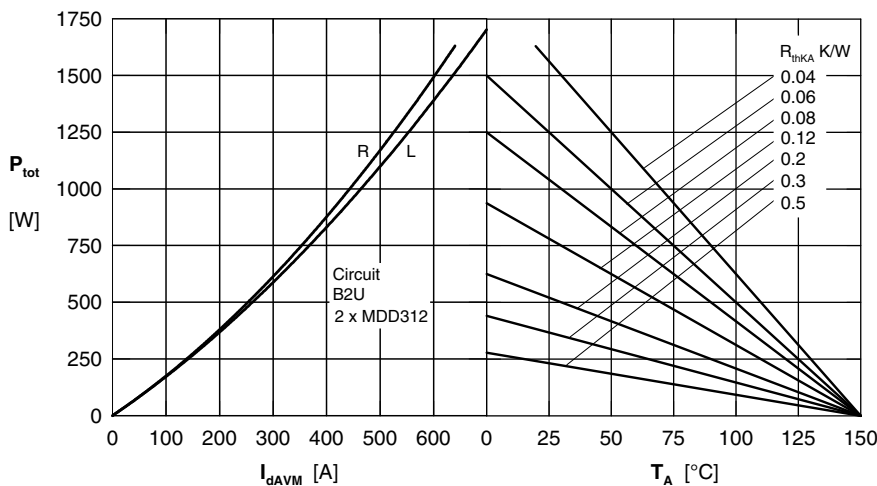

Fig. 6 Single phase rectifier bridge: Power dissipation vs. direct output current and ambient temperature R = resistive load, L = inductive load

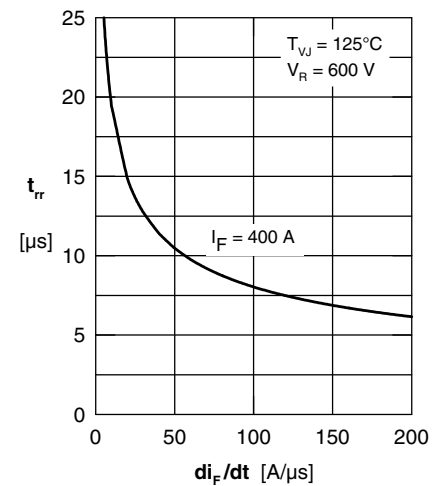

Fig. 7 Typ. recovery time t_{rr} versus $-di_F/dt$

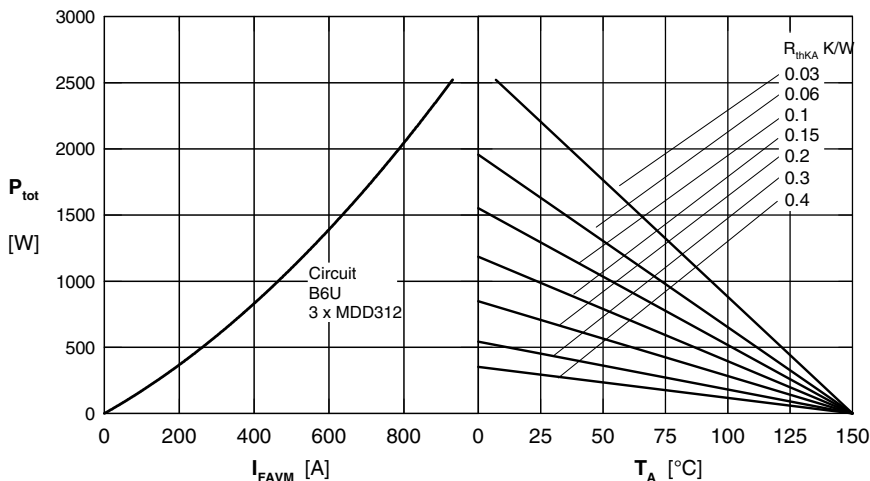
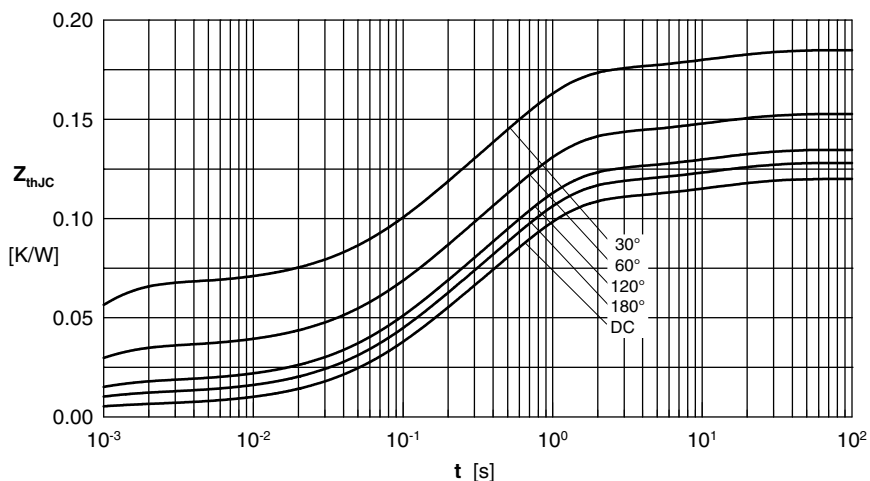

Fig. 8 Three phase rectifier bridge: Power dissipation vs. direct output current & ambient temperature



R_{thJC} for various conduction angles d :

d	R_{thJC} (K/W)
DC	0.120
180°C	0.128
120°C	0.135
60°C	0.153
30°C	0.185

Constants for Z_{thJC} calculation:

i	R_{thi} (K/W)	t_i (s)
1	0.0058	0.00054
2	0.031	0.098
3	0.072	0.54
4	0.0112	12

Fig. 9 Transient thermal impedance junction to case (per diode)

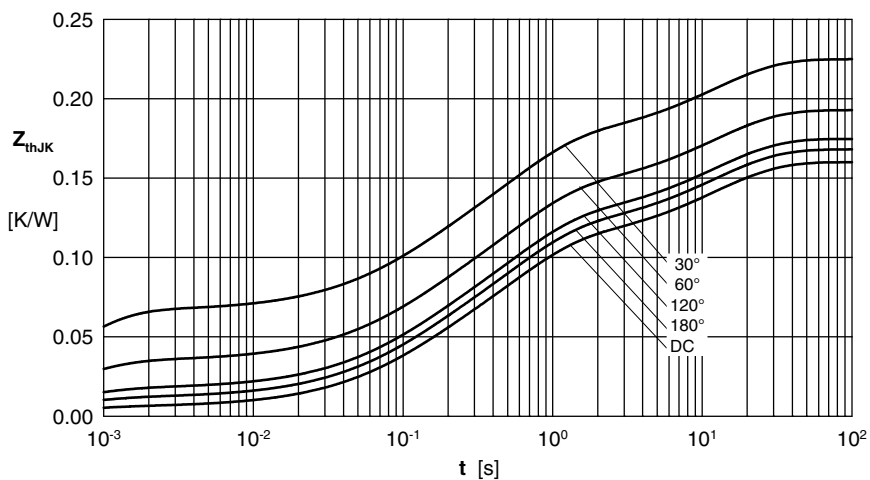

R_{thJK} for various conduction angles d :

d	R_{thJK} (K/W)
DC	0.160
180°C	0.168
120°C	0.175
60°C	0.193
30°C	0.225

Constants for Z_{thJK} calculation:

i	R_{thi} (K/W)	t_i (s)
1	0.0058	0.00054
2	0.031	0.098
3	0.072	0.54
4	0.0112	12
5	0.04	12

Fig. 10 Transient thermal impedance junction to heatsink (per diode)