



Size: 2.0in x 1.0in x 0.4in (50.8mm x 25.4mm x 10.2mm)

OPTIONS

- Heatsink
- Negative Logic Remote ON/OFF (Suffix "R")
- Input Range
- Output Voltage

FEATURES

- 20 Watts Maximum Output Power
- Output Current up to 6A
- Single and Dual Outputs
- Standard 2.0in x 1.0in x 0.4in Package
- 2:1 Input Voltage Range
- High Efficiency up to 89%
- 1600VDC I/O Isolation
- Remote ON/OFF Control
- Fixed Switching Frequency
- Short Circuit, Over Voltage, and Over Load Protection
- Six-Sided Continuous Shield
- CE Marked
- UL60950-1, EN60950-1, & IEC60950-1 Safety Approvals
- ISO9001 Certified Manufacturing Facilities
- RoHS & REACH compliant
- Heatsink Option

APPLICATIONS

- Wireless Networks
- Telecom/Datacom
- Industry Control Systems
- Measurement Equipment
- Semiconductor Equipment

DESCRIPTION

The MD series of DC/DC power converters provides up to 20 Watts of output power in a standard 2.0 x 1.0 x 0.4 inch package. This series has single and dual output models with 2:1 input voltage ranges of 9-18VDC, 18-36VDC, and 36-75VDC. Some features include high efficiency up to 89%, 1600VDC I/O isolation, remote ON/OFF, and voltage adjustability. This series is also protected against over voltage, over load, and short circuit conditions. All models are RoHS compliant and have UL60950-1, EN60950-1, and IEC60950-1 safety approvals.

MODEL SELECTION TABLE

Single Output

Model Number	Input Voltage Range	Output Voltage	Output Current		Ripple & Noise ⁽¹⁾	Input Current		Output Power	Maximum Capacitive Load	Efficiency
			Min Load	Max Load		No Load ⁽²⁾	Full Load ⁽³⁾			
MD12S1.5-6000	12VDC (9-18)	1.5VDC	0mA	6000mA	60mVp-p	70mA	1014mA	9W	65,000µF	78%
MD12S1.8-6000		1.8VDC	0mA	6000mA	60mVp-p	75mA	1200mA	10.8W	65,000µF	79%
MD12S2.5-6000		2.5VDC	0mA	6000mA	60mVp-p	80mA	1582mA	15W	33,000µF	83%
MD12S3.3-5000		3.3VDC	0mA	5000mA	60mVp-p	115mA	1698mA	16.5W	13,000µF	85%
MD12S5-4000		5VDC	0mA	4000mA	75mVp-p	75mA	2008mA	20W	6,800µF	87%
MD12S12-1670		12VDC	0mA	1670mA	75mVp-p	90mA	2037mA	20W	2,200µF	86%
MD12S15-1330		15VDC	0mA	1330mA	75mVp-p	35mA	2037mA	20W	755µF	86%
MD24S1.5-6000	24VDC (18-36VDC)	1.5VDC	0mA	6000mA	60mVp-p	35mA	493mA	9W	65,000µF	80%
MD12S1.8-6000		1.8VDC	0mA	6000mA	60mVp-p	45mA	584mA	10.8W	65,000µF	81%
MD24S2.5-6000		2.5VDC	0mA	6000mA	60mVp-p	40mA	781mA	15W	33,000µF	84%
MD24S3.3-5000		3.3VDC	0mA	5000mA	60mVp-p	30mA	838mA	16.5W	13,000µF	86%
MD24S5-4000		5VDC	0mA	4000mA	75mVp-p	35mA	980mA	20W	6,800µF	89%
MD24S12-1670		12VDC	0mA	1670mA	75mVp-p	55mA	1006mA	20W	2,200µF	87%
MD24S15-1330		15VDC	0mA	1330mA	75mVp-p	40mA	1002mA	20W	755µF	87%
MD48S1.5-6000	48VDC (36-75VDC)	1.5VDC	0mA	6000mA	60mVp-p	15mA	247mA	9W	65,000µF	80%
MD48S1.8-6000		1.8VDC	0mA	6000mA	60mVp-p	20mA	288mA	10.8W	65,000µF	82%
MD48S2.5-6000		2.5VDC	0mA	6000mA	60mVp-p	30mA	391mA	15W	33,000µF	84%
MD48S3.3-5000		3.3VDC	0mA	5000mA	60mVp-p	15mA	414mA	16.5W	13,000µF	87%
MD48S5-4000		5VDC	0mA	4000mA	75mVp-p	20mA	490mA	20W	6,800µF	89%
MD48S12-1670		12VDC	0mA	1670mA	75mVp-p	35mA	497mA	20W	2,200µF	88%
MD48S15-1330		15VDC	0mA	1330mA	75mVp-p	50mA	501mA	20W	755µF	87%

MODEL SELECTION TABLE

Dual Output

Model Number	Input Voltage Range	Output Voltage	Output Current		Ripple & Noise ⁽¹⁾	Input Current		Output Power	Maximum Capacitive Load ⁽⁴⁾	Efficiency
			Min Load	Max Load		No Load ⁽²⁾	Full Load ⁽³⁾			
MD12D12-833	12VDC	±12VDC	0mA	±833mA	100mVp-p	45mA	2032mA	20W	±680µF	86%
MD12D15-667	(9-18)	±15VDC	0mA	±667mA	100mVp-p	50mA	2034mA	20W	±450µF	86%
MD24D12-833	24VDC	±12VDC	0mA	±833mA	100mVp-p	30mA	1004mA	20W	±680µF	87%
MD24D15-667	(18-36VDC)	±15VDC	0mA	±667mA	100mVp-p	30mA	993mA	20W	±450µF	88%
MD48D12-833	48VDC	±12VDC	0mA	±833mA	100mVp-p	20mA	496mA	20W	±680µF	88%
MD48D15-667	(36-75VDC)	±15VDC	0mA	±667mA	100mVp-p	20mA	496mA	20W	±450µF	88%

SPECIFICATIONS

All specifications are based on 25°C, Nominal Input Voltage, and Maximum Output Current unless otherwise noted.
We reserve the right to change specifications based on technological advances.

SPECIFICATION	TEST CONDITIONS	Min	Typ	Max	Unit
INPUT SPECIFICATIONS					
Operating Input Voltage Range	12VDC nominal input models	9	12	18	VDC
	24VDC nominal input models	18	24	36	
	48VDC nominal input models	36	48	75	
Input Surge Voltage (100ms max)	12VDC nominal input models			36	VDC
	24VDC nominal input models			50	
	48VDC nominal input models			100	
Input Reflected Ripple Current	Nominal Input and Full Load		20		mAp-p
Input Filter			L-C Type		
OUTPUT SPECIFICATIONS					
Output Voltage		See Table			
Voltage Accuracy		-1.0		+1.0	%
Line Regulation	Low Line to High Line at Full Load	-0.2		+0.2	%
Load Regulation	No Load to Full Load	-0.5		+0.5	%
Voltage Adjustability(Single Outputs)		-10		+10	%
Cross Regulation (Dual Outputs)	Asymmetrical load 25%/100% Full Load	-5		+5	%
Output Power		See Table			
Output Current		See Table			
Minimum Load		0			%
Maximum Capacitive Load		See Table			
Ripple & Noise (20MHz bandwidth)	Measured with a 0.1µF/50V MLCC	See Table			
Transient Response Recovery Time	25% load step change		250		µs
Start-Up Time	Constant Resistive Load	Power Up		10	ms
		Remote ON/OFF		10	
Temperature Coefficient		-0.02		+0.02	%/°C
REMOTE ON/OFF CONTROL⁽⁵⁾					
Positive Logic (Standard)	DC/DC ON	Open or 3-12VDC			
	DC/DC OFF	Short or 0-1.2VDC			
Negative Logic (Option)	DC/DC ON	Short or 0-1.2VDC			
	DC/DC OFF	Open or 3-12VDC			
Input Current of CTRL Pin		-0.5		+0.5	mA
Remote OFF Input Current			2.5		mA
PROTECTION					
Short Circuit Protection		Continuous, Automatic Recovery			
Over Load Protection	% of Iout rated			150	%
Over Voltage Protection	Zener Diode Clamp	1.5V, 1.8V, 2.5V, and 3.3V Models		3.9	VDC
		5V Models		6.2	
		12V Models		15	
		15V Models		18	
ENVIRONMENTAL SPECIFICATIONS					
Operating Ambient Temperature	With Derating	-40		+100	°C
Maximum Case Temperature				+100	°C
Storage Temperature Range		-55		+125	°C
Relative Humidity		5		95	% RH
Thermal Impedance ⁽⁶⁾	Natural Convection without Heat-Sink		12		°C/Watt
	Natural Convection with Heat-Sink		10		
Thermal Shock		MIL-STD-810F			
Vibration		MIL-STD-810F			
MTBF	MIL-HDBK-217, Full Load	1,583,000 hours			

SPECIFICATIONS

All specifications are based on 25°C, Nominal Input Voltage, and Maximum Output Current unless otherwise noted.
We reserve the right to change specifications based on technological advances.

SPECIFICATION	TEST CONDITIONS		Min	Typ	Max	Unit
GENERAL SPECIFICATIONS						
Efficiency	Nominal Vin and Full Load		See Table			
Switching Frequency			450	500	550	KHz
Isolation Voltage	1 minute	Input to Output	1600			VDC
		Input to Case	1600			
		Output to Case	1600			
Isolation Resistance	500VDC		1			GΩ
Isolation Capacitance					1000	pF
PHYSICAL SPECIFICATIONS						
Weight			0.95oz (27g)			
Dimensions (L x W x H)			2in x 1in x 0.4in (50.8mm x 25.4mm x 10.2mm)			
Case Material			Nickel-Coated Copper			
Base Material			Non-Conductive Black Plastic			
Potting Material			Epoxy (UL94 V-0)			
SAFETY & EMC CHARACTERISTICS						
Safety Approvals			UL60950-1 EN60950-1 IEC60950-1			
EMI ⁽⁷⁾	EN55022					Class A Class B
ESD	EN61000-4-2	Air ±8KV Contact ±6KV				Perf. Criteria B
Radiated Immunity	EN61000-4-3	10 V/m				Perf. Criteria A
Fast Transient ⁽⁸⁾	EN61000-4-4	±2KV				Perf. Criteria A
Surge ⁽⁸⁾	EN61000-4-5	±1KV				Perf. Criteria B
Conducted Immunity	EN61000-4-6	10 Vr.m.s				Perf. Criteria A
	EN61000-4-8	100A/m continuous; 1000A/m 1 second				Perf. Criteria A

NOTES

- (1) Typical Value at Nominal Input and Full Load.
- (2) Typical Value at Nominal Input Voltage and No Load.
- (3) Maximum Value at Nominal Input Voltage and Full Load.
- (4) Test by minimum Vin and Constant Resistive Load.
- (5) The ON/OFF control pin is referenced to -Vin.
To order Negative logic Remote ON/OFF add the suffix "R" to the model number (Ex: MD48S5-4000R).
- (6) Heatsink is optional and P/N: 7G-0020C-F
- (7) The MD series can meet EN5022 Class A with an external capacitor in parallel with the input pins.
Recommended: 12Vin Models: 4.7µF/50V 1812 MLCC
24Vin Models: 2.2µF/50V 1812 MLCC
48Vin Models: 2.2µF/100V 1812 MLCC
- (8) An external input filter capacitor is required if the module has to meet EN61000-4-4, EN61000-4-5. The filter capacitor suggested is Nippon chemi-con KY series, 220µF/100V, ESR 48mΩ.
- (9) CAUTION: The power module is not internally fused. An input line fuse must always be used.

Due to advances in technology, specifications subject to change without notice.

DERATING CURVES

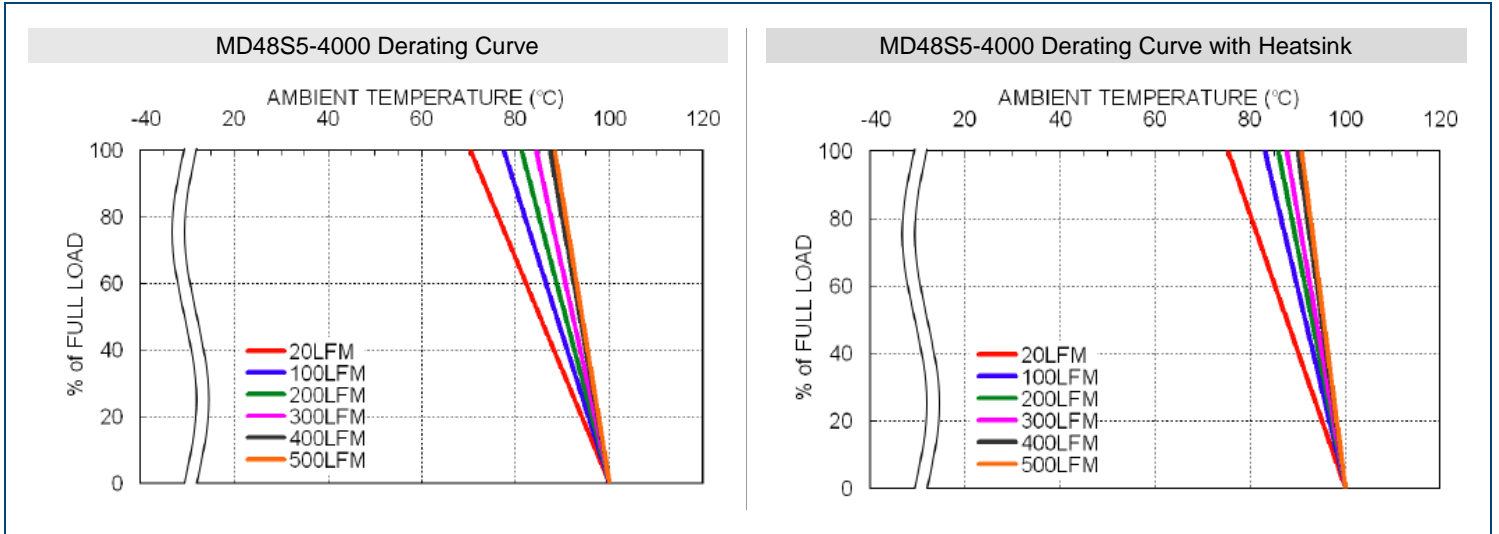

EFFICIENCY GRAPHS

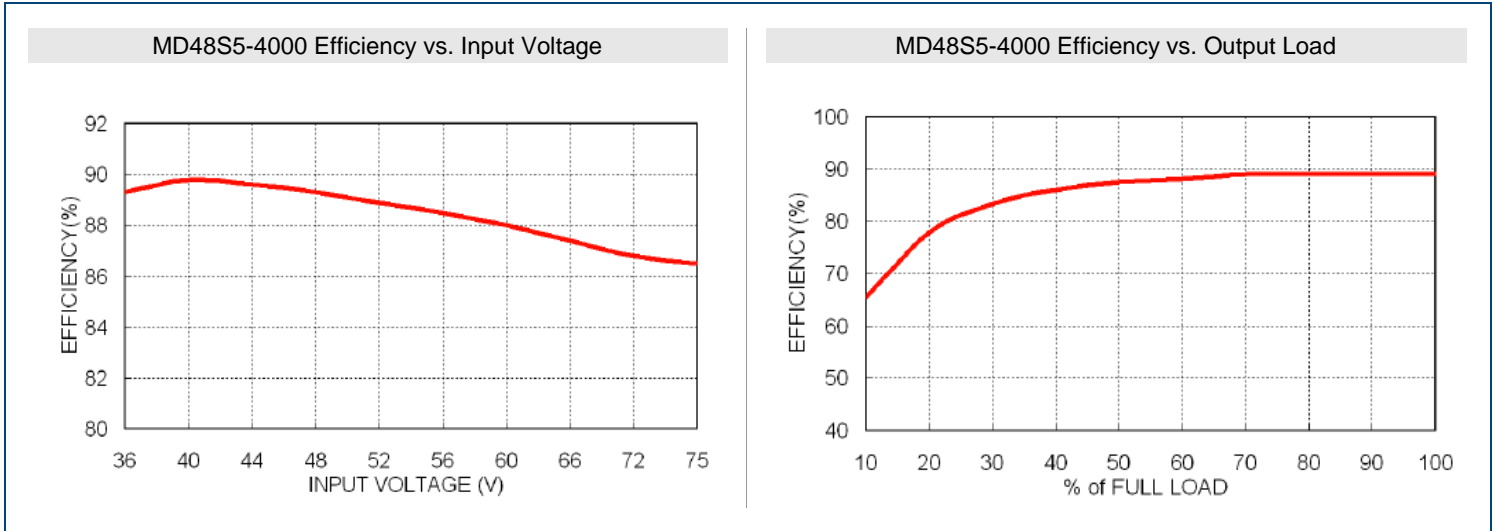

MECHANICAL DRAWINGS

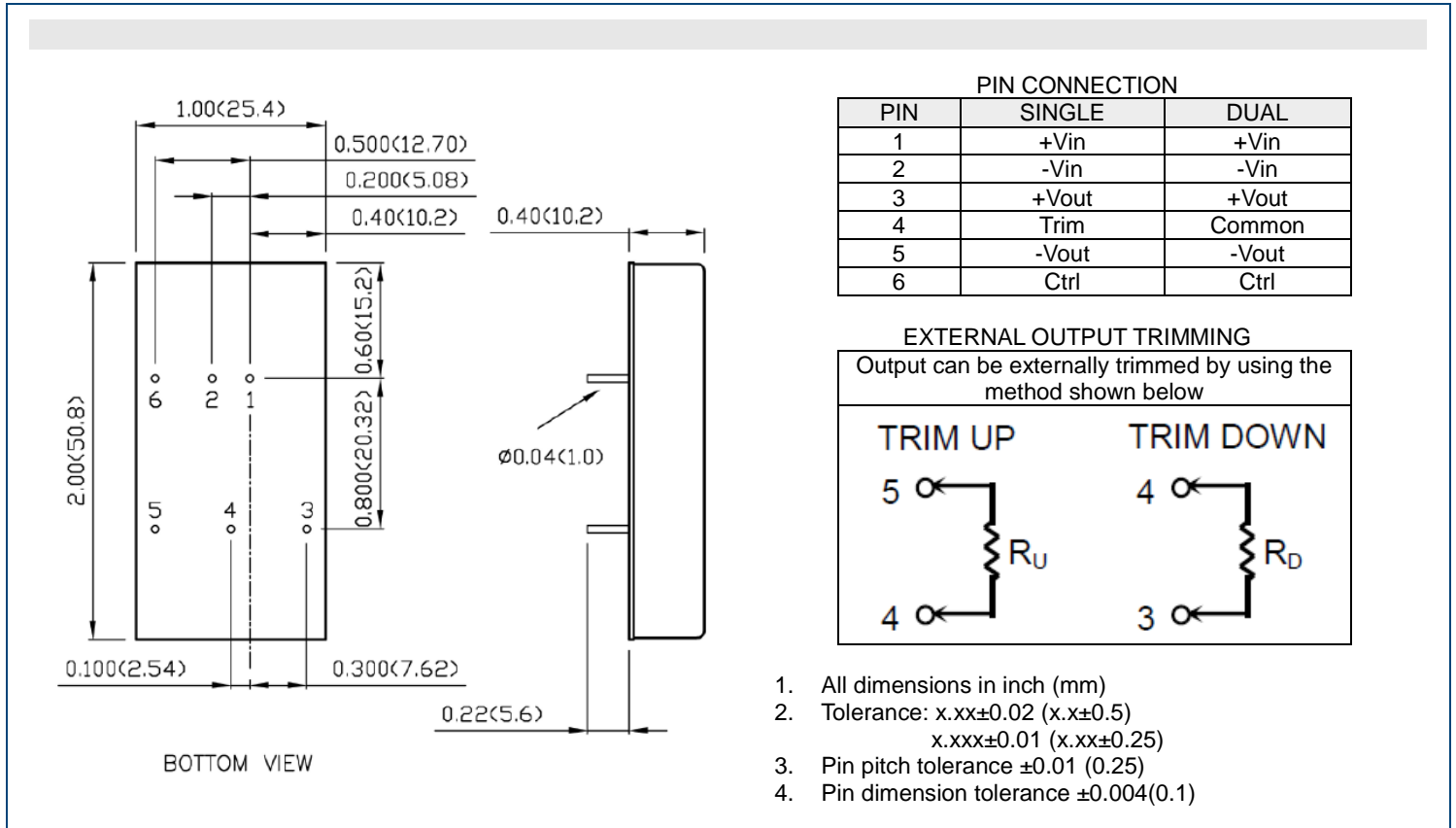

REMOTE ON/OFF CONTROL

The remote ON/OFF pin allows the user to turn the DC/DC power module on during a logic high and off during a logic low. Figure 2 gives several examples of acceptable configurations. The remote ON/OFF pin is an open collector/drain logic input signal (V_{on/off}) that has -Vin as the reference voltage. If not using the remote on/off feature, open the circuit between the on/off pin and the -input pin to turn the module on.

Remote ON/OFF Implementation

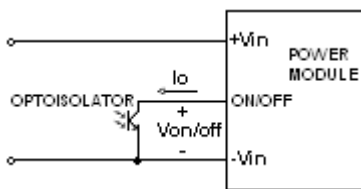

Isolated-Closure Remote ON/OFF

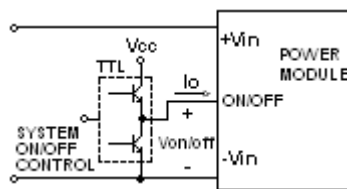

Level Control Using TTL Output

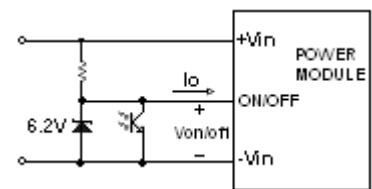

Level Control Using Line Voltage

OUTPUT VOLTAGE ADJUSTMENT

Output voltage set point adjustment allows the user to increase or decrease the output voltage set point of a module. This is accomplished by connecting an external resistor between the TRIM pin and either the +Vout or -Vout pins. With an external resistor between the TRIM and -Vout pin, the output voltage set point increases. With an external resistor between the TRIM and +Vout pin, the output voltage set point decreases.

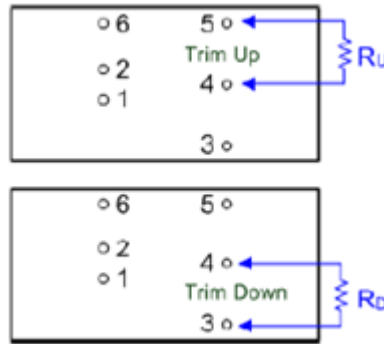

MDxxS1.5-5500

Trim	Trim _{up}	R _{up}	Trim _{down}	R _{down}
1%	1.515V	4.578 kΩ	1.485V	5.704 kΩ
2%	1.53V	2.065 kΩ	1.47V	2.571 kΩ
3%	1.545V	1.227 kΩ	1.455V	1.527 kΩ
4%	1.56V	0.808 kΩ	1.44V	1.005 kΩ
5%	1.575V	0.557 kΩ	1.425V	0.692 kΩ
6%	1.59V	0.389 kΩ	1.41V	0.483 kΩ
7%	1.605V	0.27 kΩ	1.395V	0.334 kΩ
8%	1.62V	0.18 kΩ	1.38V	0.222 kΩ
9%	1.635V	0.11 kΩ	1.365V	0.135 kΩ
10%	1.65V	0.054 kΩ	1.35V	0.065 kΩ

MDxxS1.8-5500

Trim	Trim _{up}	R _{up}	Trim _{down}	R _{down}
1%	1.818V	11.639 kΩ	1.782V	14.66 kΩ
2%	1.836V	5.205 kΩ	1.764V	6.57 kΩ
3%	1.854V	3.06 kΩ	1.746V	3.874 kΩ
4%	1.872V	1.988 kΩ	1.728V	2.525 kΩ
5%	1.89V	1.344 kΩ	1.71V	1.716 kΩ
6%	1.908V	0.915 kΩ	1.692V	1.177 kΩ
7%	1.926V	0.609 kΩ	1.674V	0.792 kΩ
8%	1.944V	0.379 kΩ	1.656V	0.503 kΩ
9%	1.962V	0.2 kΩ	1.638V	0.278 kΩ
10%	1.98V	0.057 kΩ	1.62V	0.098 kΩ

MDxxS2.5-5500

Trim	Trim _{up}	R _{up}	Trim _{down}	R _{down}
1%	2.525V	37.076 kΩ	2.475V	49.641 kΩ
2%	2.55V	16.675 kΩ	2.45V	22.481 kΩ
3%	2.575V	9.874 kΩ	2.425V	13.428 kΩ
4%	2.6V	6.474 kΩ	2.4V	8.902 kΩ
5%	2.625V	4.434 kΩ	2.375V	6.186 kΩ
6%	2.65V	3.074 kΩ	2.35V	4.375 kΩ
7%	2.675V	2.102 kΩ	2.325V	3.082 kΩ
8%	2.7V	1.374 kΩ	2.3V	2.112 kΩ
9%	2.725V	0.807 kΩ	2.275V	1.358 kΩ
10%	2.75V	0.354 kΩ	2.25V	0.754 kΩ

MDxxS3.3-5000

Trim	Trim _{up}	R _{up}	Trim _{down}	R _{down}
1%	3.333V	57.930 kΩ	3.267V	69.470 kΩ
2%	3.366V	26.165 kΩ	3.234V	31.235 kΩ
3%	3.399V	15.577 kΩ	3.201V	18.490 kΩ
4%	3.432V	10.283 kΩ	3.168V	12.117 kΩ
5%	3.465V	7.106 kΩ	3.135V	8.294 kΩ
6%	3.498V	4.988 kΩ	3.102V	5.745 kΩ
7%	3.531V	3.476 kΩ	3.069V	3.924 kΩ
8%	3.564V	2.341 kΩ	3.036V	2.559 kΩ
9%	3.597V	1.459 kΩ	3.003V	1.497 kΩ
10%	3.630V	0.753 kΩ	2.970V	0.647 kΩ

MDxxS5-4000

Trim	Trim _{up}	R _{up}	Trim _{down}	R _{down}
1%	5.050V	36.570 kΩ	4.950V	45.533 kΩ
2%	5.100V	16.580 kΩ	4.900V	20.612 kΩ
3%	5.150V	9.917 kΩ	4.850V	12.306 kΩ
4%	5.200V	6.585 kΩ	4.800V	8.152 kΩ
5%	5.250V	4.586 kΩ	4.750V	5.660 kΩ
6%	5.300V	3.253 kΩ	4.700V	3.999 kΩ
7%	5.350V	2.302 kΩ	4.650V	2.812 kΩ
8%	5.400V	1.588 kΩ	4.600V	1.922 kΩ
9%	5.450V	1.032 kΩ	4.550V	1.230 kΩ
10%	5.500V	0.588 kΩ	4.500V	0.676 kΩ

MDxxS15-1330

Trim	Trim _{up}	R _{up}	Trim _{down}	R _{down}
1%	15.150V	404.184 kΩ	14.850V	499.816 kΩ
2%	15.300V	180.592 kΩ	14.700V	223.408 kΩ
3%	15.450V	106.061 kΩ	14.550V	131.272 kΩ
4%	15.600V	68.796 kΩ	14.400V	85.204 kΩ
5%	15.750V	46.437 kΩ	14.250V	57.563 kΩ
6%	15.900V	31.531 kΩ	14.100V	39.136 kΩ
7%	16.050V	20.883 kΩ	13.950V	25.974 kΩ
8%	16.200V	12.898 kΩ	13.800V	16.102 kΩ
9%	16.350V	6.687 kΩ	13.650V	8.424 kΩ
10%	16.500V	1.718 kΩ	13.500V	2.282 kΩ

MDxxS12-1670

Trim	Trim _{up}	R _{up}	Trim _{down}	R _{down}
1%	12.120V	367.908 kΩ	11.880V	460.992 kΩ
2%	12.240V	165.954 kΩ	11.760V	207.946 kΩ
3%	12.360V	98.636 kΩ	11.640V	123.597 kΩ
4%	12.480V	64.977 kΩ	11.520V	81.423 kΩ
5%	12.600V	44.782 kΩ	11.400V	56.118 kΩ
6%	12.720V	31.318 kΩ	11.280V	39.249 kΩ
7%	12.840V	21.701 kΩ	11.160V	27.199 kΩ
8%	12.960V	14.488 kΩ	11.040V	18.162 kΩ
9%	13.080V	8.879 kΩ	10.920V	11.132 kΩ
10%	13.200V	4.391 kΩ	10.800V	5.509 kΩ

MDxxD12-833

Trim	Trim _{up}	R _{up}	Trim _{down}	R _{down}
1%	24.24V	218.21 kΩ	23.76V	273.44 kΩ
2%	24.48V	98.105 kΩ	23.52V	123.02 kΩ
3%	24.72V	58.07 kΩ	23.28V	72.874 kΩ
4%	24.96V	38.052 kΩ	23.04V	47.803 kΩ
5%	25.2V	26.042 kΩ	22.8V	32.76 kΩ
6%	25.44V	18.035 kΩ	22.56V	22.732 kΩ
7%	25.68V	12.316 kΩ	22.32V	15.568 kΩ
8%	25.92V	8.026 kΩ	22.08V	10.196 kΩ
9%	26.16V	4.69 kΩ	21.84V	6.017 kΩ
10%	26.4V	2.021 kΩ	21.6V	2.675 kΩ

MDxxD15-667

Trim	Trim _{up}	R _{up}	Trim _{down}	R _{down}
1%	30.3V	268.29 kΩ	29.7V	337.71 kΩ
2%	30.6V	120.64 kΩ	29.4V	152.02 kΩ
3%	30.9V	71.429 kΩ	29.1V	90.126 kΩ
4%	31.2V	46.822 kΩ	28.8V	59.178 kΩ
5%	31.5V	32.058 kΩ	28.5V	40.609 kΩ
6%	31.8V	22.215 kΩ	28.2V	28.23 kΩ
7%	32.1V	15.184 kΩ	27.9V	19.387 kΩ
8%	32.4V	9.911 kΩ	27.6V	12.756 kΩ
9%	32.7V	5.81 kΩ	27.3V	7.598 kΩ
10%	33V	2.529 kΩ	27V	3.471 kΩ

RECOMMENDED FILTERS

Recommended Filter for EN55022 Class B Compliance

Recommended EN55022 Class B Filter Circuit Layout

The components used in the figure above are as follows:

	C1	C2	C3	C4	L1
MD12xxx-xxxx	3.3µF/50V 1812 MLCC	3.3µF/50V 1812 MLCC	1000pF/2KV MLCC	1000pF/2KV MLCC	450µH Common Choke PMT-048
MD24xxx-xxxx	4.7µF/50V 1812 MLCC	N/A	1000pF/2KV MLCC	1000pF/2KV MLCC	450µH Common Choke PMT-048
MD48xxx-xxxx	2.2µF/100V 1812 MLCC	2.2µF/100V 1812 MLCC	1000pF/2KV MLCC	1000pF/2KV MLCC	325µH Common Choke PMT-050

COMPANY INFORMATION

Wall Industries, Inc. has created custom and modified units for over 50 years. Our in-house research and development engineers will provide a solution that exceeds your performance requirements on-time and on budget. Our ISO9001-2008 certification is just one example of our commitment to producing a high quality, well-documented product for our customers.

Our past projects demonstrate our commitment to you, our customer. Wall Industries, Inc. has a reputation for working closely with its customers to ensure each solution meets or exceeds form, fit and function requirements. We will continue to provide ongoing support for your project above and beyond the design and production phases. Give us a call today to discuss your future projects.

Contact **Wall Industries** for further information:

Phone: ☎(603)778-2300
 Toll Free: ☎(888)597-9255
 Fax: ☎(603)778-9797
 E-mail: sales@wallindustries.com
 Web: www.wallindustries.com
 Address: 37 Industrial Drive
 Exeter, NH 03833