

SERIES: MD-XXCV | **DESCRIPTION:** MINI DIN CONNECTOR

FEATURES

- panel mount
- locking nut
- plastic bushing

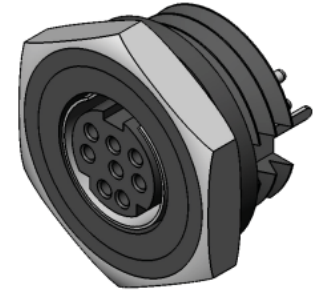
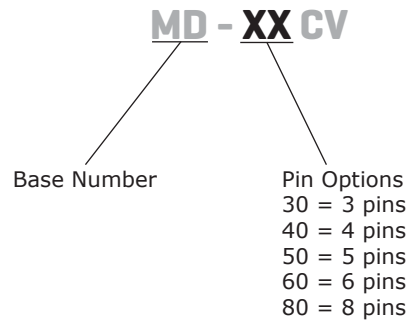

PART NUMBER KEY

SPECIFICATIONS

parameter	conditions/description	min	typ	max	units
rated input voltage			100 12		Vac Vdc
rated input current	at 100 Vac at 12 Vdc			1 2	A A
contact resistance				30	mΩ
insulation resistance	at 250 Vdc	50			MΩ
voltage withstand	for 1 minute			250	Vac
insertion force		1		4.5	kg
withdrawal force		0.8		3	kg
operating temperature		-40		85	°C
life			1,000		cycles

MECHANICAL DRAWINGS

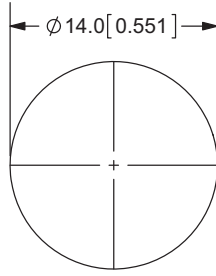
units: mm[inches]

TOLERANCE: ±0.2mm



RECOMMENDED
PANEL CUTOUT

	MATERIAL	PLATING
earth terminal	brass	tin
terminal contacts (1~8)	phosphor bronze	silver
housing	PBT	

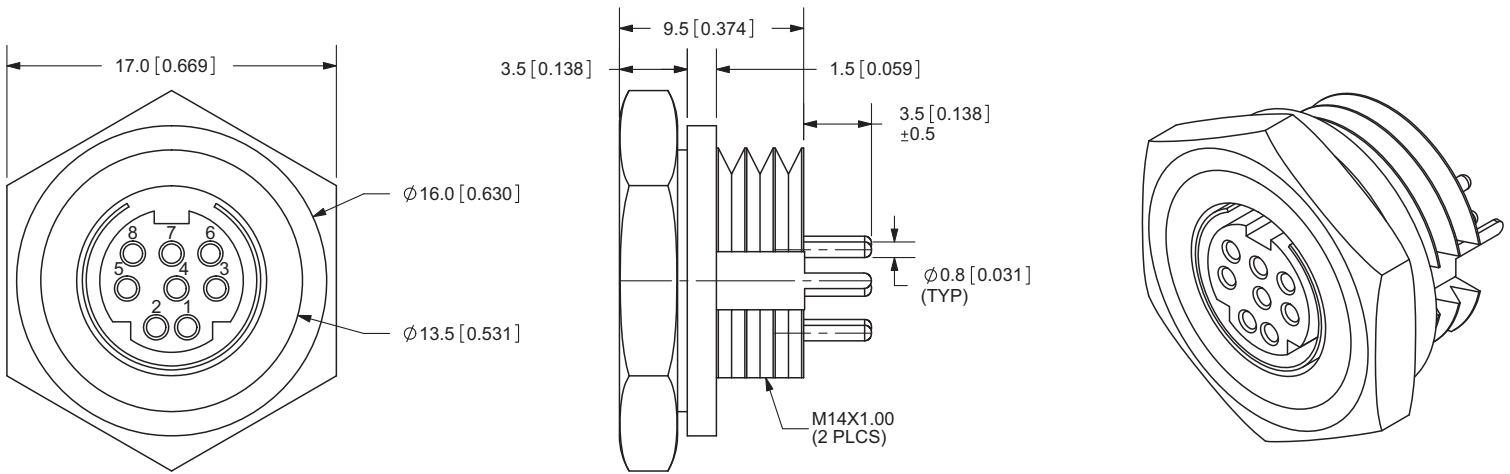

MD-30CV

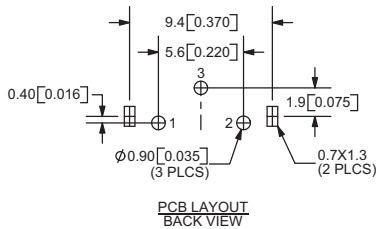
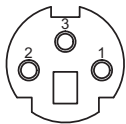

MD-40CV

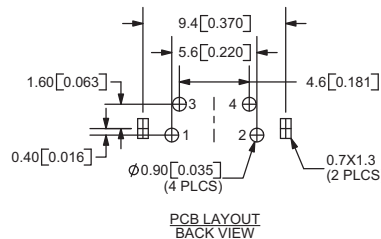
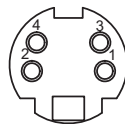

MD-50CV

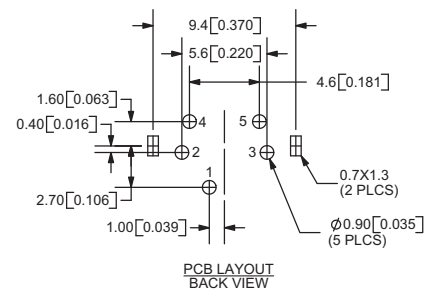
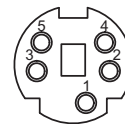

MD-60CV

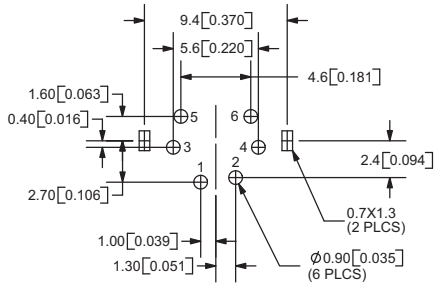
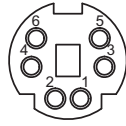

PCB LAYOUT
BACK VIEW

MD-80CV

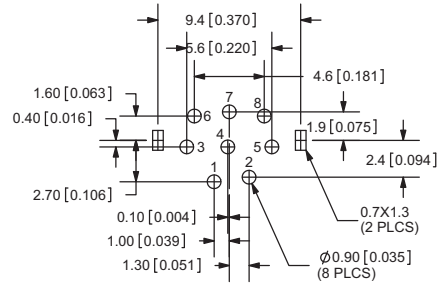
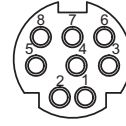

PCB LAYOUT
BACK VIEW

REVISION HISTORY

rev.	description	date
1.0	initial release	02/23/2006
1.01	new template applied	02/20/2012

The revision history provided is for informational purposes only and is believed to be accurate.



Headquarters
 20050 SW 112th Ave.
 Tualatin, OR 97062
800.275.4899

Fax 503.612.2383
 cui.com
 techsupport@cui.com

CUI offers a one (1) year limited warranty. Complete warranty information is listed on our website.

CUI reserves the right to make changes to the product at any time without notice. Information provided by CUI is believed to be accurate and reliable. However, no responsibility is assumed by CUI for its use, nor for any infringements of patents or other rights of third parties which may result from its use.

CUI products are not authorized or warranted for use as critical components in equipment that requires an extremely high level of reliability. A critical component is any component of a life support device or system whose failure to perform can be reasonably expected to cause the failure of the life support device or system, or to affect its safety or effectiveness.