

MC74VHC1G03

Product Preview

2-Input NOR Gate with Open Drain Output

The MC74VHC1G03 is an advanced high speed CMOS 2-input NOR gate with an open drain output fabricated with silicon gate CMOS technology. It achieves high speed operation similar to equivalent Bipolar Schottky TTL while maintaining CMOS low power dissipation.

The internal circuit is composed of three stages, including an open drain output which provides the capability to set output switching level. This allows the MC74VHC1G03 to be used to interface 5V circuits to circuits of any voltage between VCC and 7V using an external resistor and power supply.

The MC74VHC1G03 input structure provides protection when voltages up to 7V are applied, regardless of the supply voltage.

- High Speed: $t_{PD} = 3.6ns$ (Typ) at $V_{CC} = 5V$
- Low Internal Power Dissipation: $I_{CC} = 2\mu A$ (Max) at $T_A = 25^\circ C$
- Power Down Protection Provided on Inputs
- Pin and Function Compatible with Other Standard Logic Families
- Latchup Performance Exceeds 300mA
- ESD Performance: HBM > 2000V; MM > 200V, CDM > 1500V

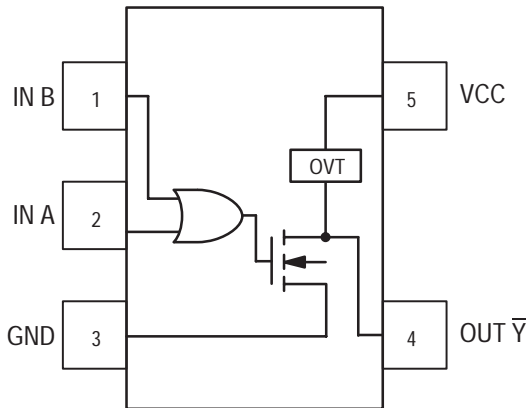
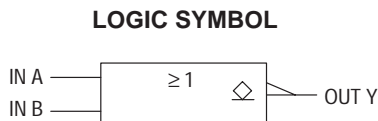

Figure 1. 5-Lead SOT-353 Pinout (Top View)



This document contains information on a product under development. ON Semiconductor reserves the right to change or discontinue this product without notice.



ON Semiconductor
Formerly a Division of Motorola
<http://onsemi.com>

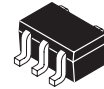

SC-88A / SOT-353
DF SUFFIX
CASE 419A

MARKING DIAGRAM

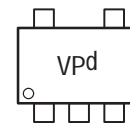

Pin 1
d = Date Code

| PIN ASSIGNMENT | |
|----------------|---------------|
| 1 | IN B |
| 2 | IN A |
| 3 | GND |
| 4 | OUT \bar{Y} |
| 5 | VCC |

ORDERING INFORMATION

See detailed ordering and shipping information in the package dimensions section on page 4 of this data sheet.

FUNCTION TABLE

| Inputs | | Output |
|--------|---|-----------|
| A | B | \bar{Y} |
| L | L | Z |
| L | H | L |
| H | L | L |
| H | H | L |

MC74VHC1G03

MAXIMUM RATINGS*

| Characteristics | Symbol | Value | Unit |
|---------------------------------------------------------------|-----------|--------------|------|
| DC Supply Voltage | V_{CC} | -0.5 to +7.0 | V |
| DC Input Voltage | V_{IN} | -0.5 to +7.0 | V |
| DC Output Voltage | V_{OUT} | -0.5 to 7.0 | V |
| Input Diode Current | I_{IK} | -20 | mA |
| Output Diode Current ($V_{OUT} < GND$; $V_{OUT} > V_{CC}$) | I_{OK} | +20 | mA |
| DC Output Current, per Pin | I_{OUT} | +25 | mA |
| DC Supply Current, V_{CC} and GND | I_{CC} | +50 | mA |
| Power dissipation in still air, SC-88A † | P_D | 200 | mW |
| Lead temperature, 1 mm from case for 10 s | T_L | 260 | °C |
| Storage temperature | T_{stg} | -65 to +150 | °C |

* Maximum Ratings are those values beyond which damage to the device may occur. Exposure to these conditions or conditions beyond those indicated may adversely affect device reliability. Functional operation under absolute-maximum-rated conditions is not implied. Functional operation should be restricted to the Recommended Operating Conditions.

† Derating — SC-88A Package: -3 mW/°C from 65° to 125°C

RECOMMENDED OPERATING CONDITIONS

| Characteristics | Symbol | Min | Max | Unit |
|----------------------------------------------------------------------------------|------------|-----|-----------|------|
| DC Supply Voltage | V_{CC} | 2.0 | 5.5 | V |
| DC Input Voltage | V_{IN} | 0.0 | 5.5 | V |
| DC Output Voltage | V_{OUT} | 0.0 | 7.0 | V |
| Operating Temperature Range | T_A | -55 | +85 | °C |
| Input Rise and Fall Time $V_{CC} = 3.3V \pm 0.3V$ $V_{CC} = 5.0V \pm 0.5V$ | t_r, t_f | 0 | 100 20 | ns/V |

MC74VHC1G03

DC ELECTRICAL CHARACTERISTICS

| Symbol | Parameter | Test Conditions | V _{CC} (V) | T _A = 25°C | | | T _A ≤ 85°C | | T _A ≤ 125°C | | Unit |
|------------------|-------------------------------------------------------------------------------------------|----------------------------------------------------------------------------------------------------------|--------------------------|----------------------------|-------------------|----------------------------|----------------------------|----------------------------|----------------------------|----------------------------|------|
| | | | | Min | Typ | Max | Min | Max | Min | Max | |
| V _{IH} | Minimum High-Level Input Voltage | | 2.0 3.0 4.5 5.5 | 1.5 2.1 3.15 3.85 | | | 1.5 2.1 3.15 3.85 | | 1.5 2.1 3.15 3.85 | V | |
| V _{IL} | Maximum Low-Level Input Voltage | | 2.0 3.0 4.5 5.5 | | | 0.5 0.9 1.35 1.65 | | 0.5 0.9 1.35 1.65 | | 0.5 0.9 1.35 1.65 | V |
| V _{OH} | Minimum High-Level Output Voltage V _{IN} = V _{IH} or V _{IL} | V _{IN} = V _{IH} or V _{IL} I _{OH} = -50μA | 2.0 3.0 4.5 | 1.9 2.9 4.4 | 2.0 3.0 4.5 | | 1.9 2.9 4.4 | | 1.9 2.9 4.4 | V | |
| | | V _{IN} = V _{IH} or V _{IL} I _{OH} = -4mA I _{OH} = -8mA | 3.0 4.5 | 2.58 3.94 | | | 2.48 3.80 | | 2.34 3.66 | V | |
| V _{OL} | Maximum Low-Level Output Voltage V _{IN} = V _{IH} or V _{IL} | V _{IN} = V _{IH} or V _{IL} I _{OL} = 50μA | 2.0 3.0 4.5 | | 0.0 0.0 0.0 | 0.1 0.1 0.1 | | 0.1 0.1 0.1 | | 0.1 0.1 0.1 | V |
| | | V _{IN} = V _{IH} or V _{IL} I _{OL} = 4mA I _{OL} = 8mA | 3.0 4.5 | | | 0.36 0.36 | 0.44 0.44 | | 0.52 0.52 | V | |
| I _{IN} | Maximum Input Leakage Current | V _{IN} = 5.5V or GND | 0 to 5.5 | | | ±0.1 | | ±1.0 | | ±1.0 | μA |
| I _{CC} | Maximum Quiescent Supply Current | V _{IN} = V _{CC} or GND | 5.5 | | | 2.0 | | 20 | | 40 | μA |
| I _{OPD} | Maximum Off-state Leakage Current | V _{OUT} = 5.5V | 0 | | | 0.25 | | 2.5 | | 5.0 | μA |

AC ELECTRICAL CHARACTERISTICS (C_{load} = 50 pF, Input t_r = t_f = 3.0ns)

| Symbol | Parameter | Test Conditions | T _A = 25°C | | | T _A ≤ 85°C | | T _A ≤ 125°C | | Unit |
|------------------|-----------------------------------------------|--------------------------------------------------------------------------------|-----------------------|-----|------|-----------------------|------|------------------------|------|------|
| | | | Min | Typ | Max | Min | Max | Min | Max | |
| t _{PZL} | Maximum Output Enable Time, Input A or B to Y | V _{CC} = 3.0 ± 0.3V R _L = 1KΩ C _L = 15 pF | | 5.6 | 7.9 | | 9.5 | | 11.0 | ns |
| | | C _L = 50 pF | | 8.1 | 11.4 | | 13.0 | | 15.5 | |
| t _{PLZ} | Maximum Output Disable Time | V _{CC} = 5.0 ± 0.5V R _L = 1KΩ C _L = 50 pF | | 3.6 | 5.5 | | 6.5 | | 8.0 | ns |
| | | C _L = 50 pF | | 5.1 | 7.5 | | 8.5 | | 10.0 | |
| C _{IN} | Maximum Input Capacitance | V _{CC} = 3.0 ± 0.3V, R _L = 1KΩ, C _L = 50 pF | | 8.1 | 11.4 | | 13.0 | | 15.5 | pF |
| | | V _{CC} = 5.0 ± 0.5V, R _L = 1KΩ, C _L = 50 pF | | 5.1 | 7.5 | | 8.5 | | 10.0 | |
| C _{PD} | Power Dissipation Capacitance (Note 1.) | | | 4 | 10 | | 10 | | 10 | pF |

| C _{PD} | Power Dissipation Capacitance (Note 1.) | Typical @ 25°C, V _{CC} = 5.0V | | pF |
|-----------------|-----------------------------------------|----------------------------------------|-----|----|
| | | Min | Max | |
| | | | 18 | |

1. C_{PD} is defined as the value of the internal equivalent capacitance which is calculated from the operating current consumption without load. Average operating current can be obtained by the equation: I_{CC(OPR)} = C_{PD} • V_{CC} • f_{in} + I_{CC}. C_{PD} is used to determine the no-load dynamic power consumption; P_D = C_{PD} • V_{CC}² • f_{in} + I_{CC} • V_{CC}.

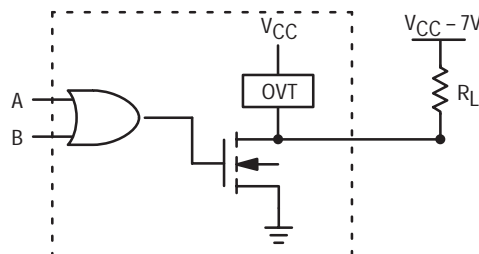

Figure 2. Output Voltage Mismatch Application

MC74VHC1G03

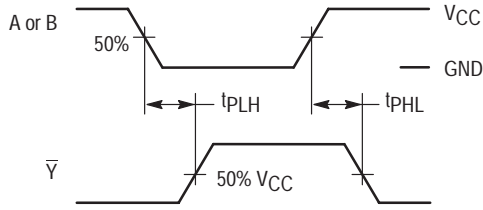
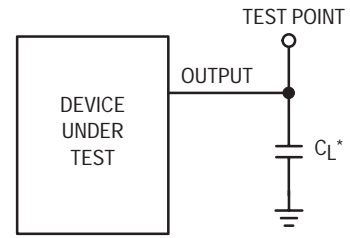

Figure 3. Switching Waveforms



*Includes all probe and jig capacitance

Figure 4. Test Circuit

DEVICE ORDERING INFORMATION

| Device Order Number | Device Nomenclature | | | | | | Package Type | Tape and Reel Size |
|---------------------|---------------------|-----------------------|------------|-----------------|----------------|--------------------|------------------|--------------------|
| | Circuit Indicator | Temp Range Identifier | Technology | Device Function | Package Suffix | Tape & Reel Suffix | | |
| MC74VHC1G03DFT1 | MC | 74 | VHC1G | 03 | DF | T1 | SC-88A / SOT-353 | 7-Inch/3000 Unit |

PACKAGE DIMENSIONS

SC-88A / SOT-353
DF SUFFIX
5-LEAD PACKAGE
CASE 419A-01
ISSUE B

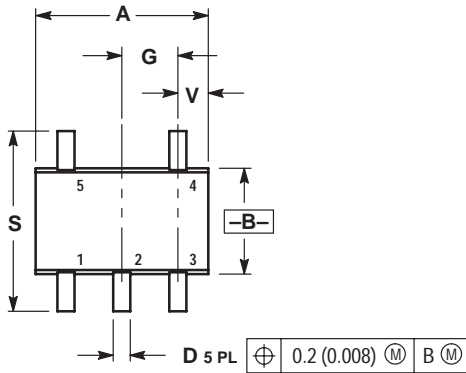

- NOTES:
1. DIMENSIONING AND TOLERANCING PER ANSI Y14.5M, 1982.
2. CONTROLLING DIMENSION: MM.

| DIM | INCHES | | MILLIMETERS | |
|-----|-----------|-------|-------------|------|
| | MIN | MAX | MIN | MAX |
| A | 0.071 | 0.087 | 1.80 | 2.20 |
| B | 0.045 | 0.053 | 1.15 | 1.35 |
| C | 0.031 | 0.043 | 0.80 | 1.10 |
| D | 0.004 | 0.012 | 0.10 | 0.30 |
| G | 0.026 BSC | | 0.65 BSC | |
| H | --- | 0.004 | --- | 0.10 |
| J | 0.004 | 0.010 | 0.10 | 0.25 |
| K | 0.004 | 0.012 | 0.10 | 0.30 |
| N | 0.008 REF | | 0.20 REF | |
| S | 0.079 | 0.087 | 2.00 | 2.20 |
| V | 0.012 | 0.016 | 0.30 | 0.40 |

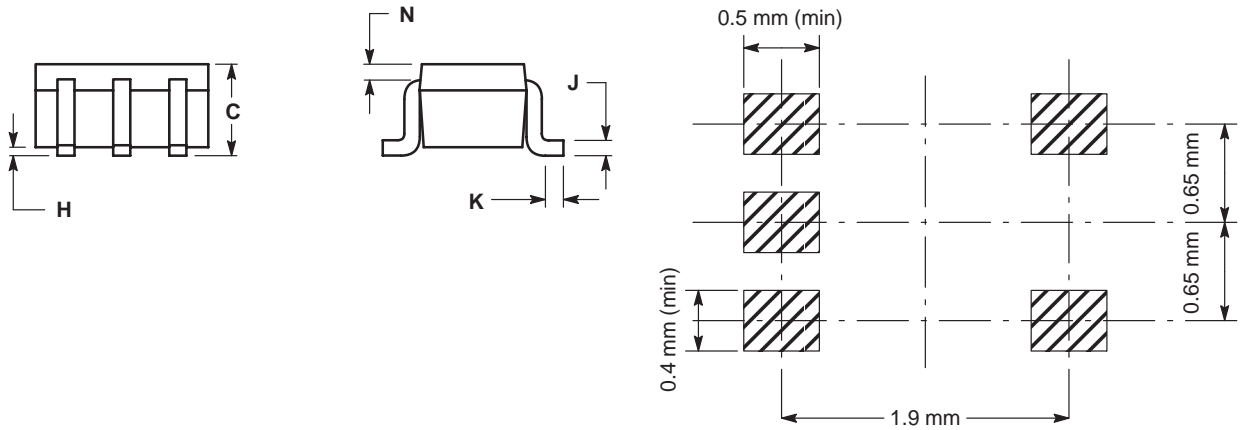

MC74VHC1G03

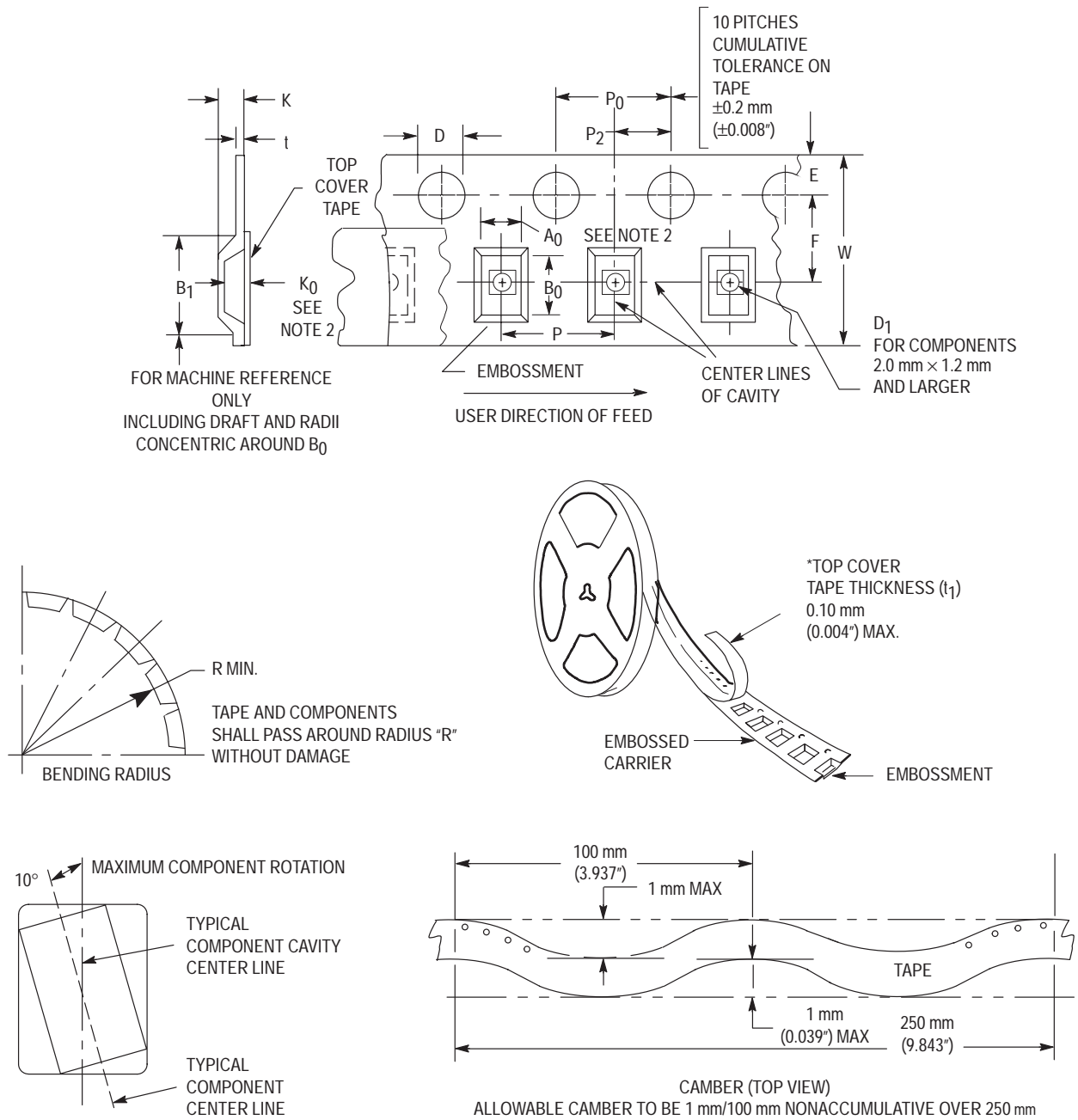

Figure 5. Carrier Tape Specifications

EMBOSSED CARRIER DIMENSIONS (See Notes 1 and 2)

| Tape Size | B ₁ Max | D | D ₁ | E | F | K | P | P ₀ | P ₂ | R | T | W |
|-----------|--------------------|---------------------------------------|---------------------|------------------------------|----------------------------|-----------------|------------------------------|-----------------------------|-----------------------------|---------------|--------------------------------------|-----------------------------|
| 8 mm | 4.35 mm (0.171") | 1.5 +0.1/-0.0 mm (0.059 +0.004/-0.0") | 1.0 mm Min (0.039") | 1.75 ±0.1 mm (0.069 ±0.004") | 3.5 ±0.5 mm (1.38 ±0.002") | 2.4 mm (0.094") | 4.0 ±0.10 mm (0.157 ±0.004") | 4.0 ±0.1 mm (0.156 ±0.004") | 2.0 ±0.1 mm (0.079 ±0.002") | 25 mm (0.98") | 0.3 ±0.05 mm (0.01 +0.0038/-0.0002") | 8.0 ±0.3 mm (0.315 ±0.012") |

1. Metric Dimensions Govern—English are in parentheses for reference only.
2. A₀, B₀, and K₀ are determined by component size. The clearance between the components and the cavity must be within 0.05 mm min to 0.50 mm max. The component cannot rotate more than 10° within the determined cavity

MC74VHC1G03

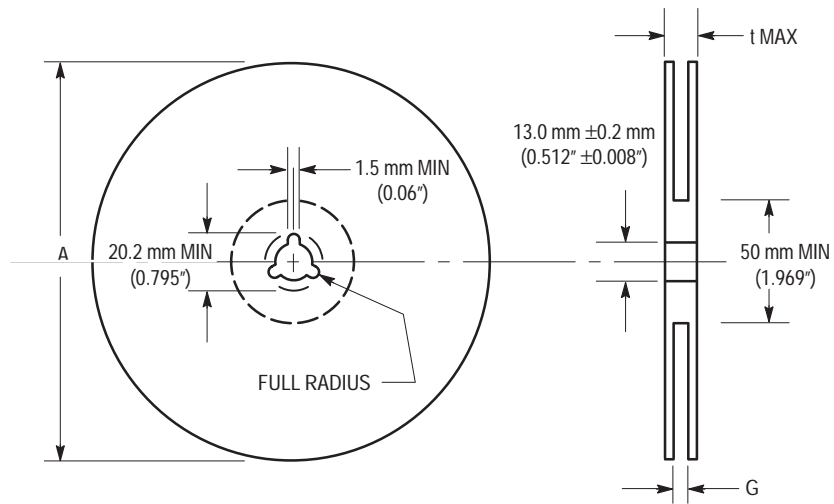

Figure 6. Reel Dimensions

REEL DIMENSIONS

| Tape Size | A Max | G | t Max |
|-----------|-----------------|----------------------------------------------------|--------------------|
| 8 mm | 330 mm (13") | 8,400 mm, +1.5 mm, -0.0 (0.33", +0.059", -0.00) | 14.4 mm (0.56") |

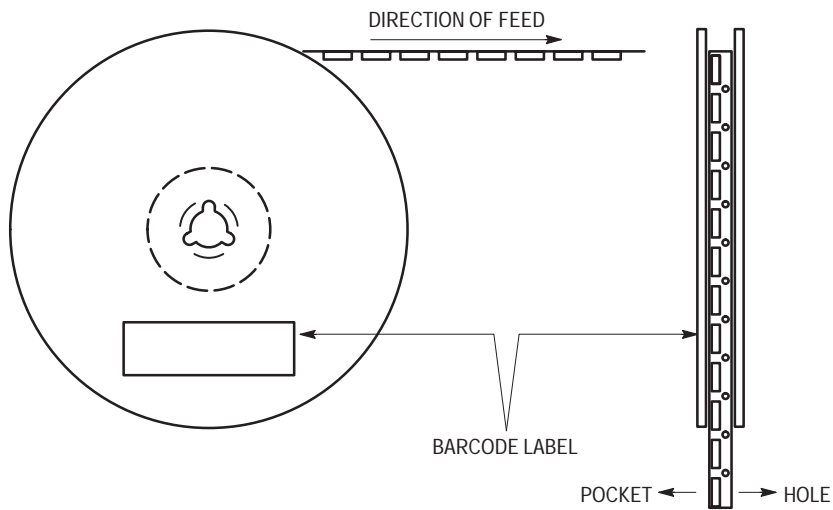

Figure 7. Reel Winding Direction

MC74VHC1G03

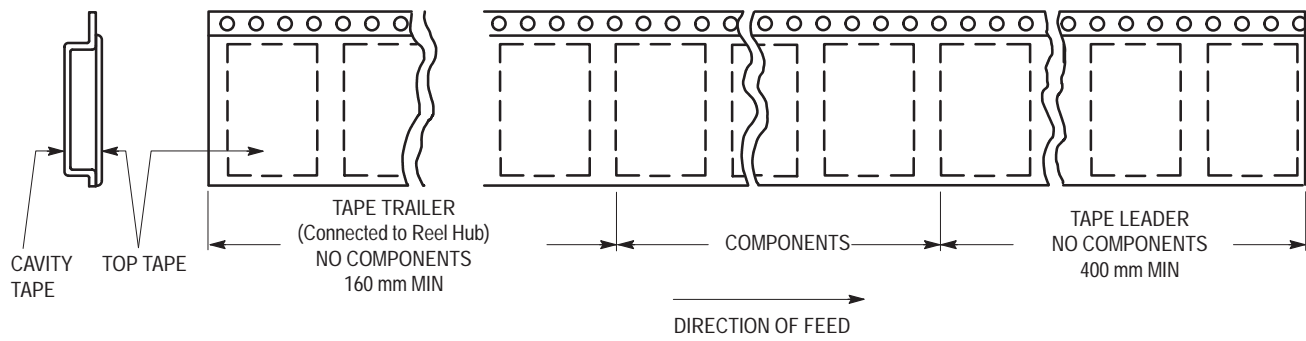

Figure 8. Tape Ends for Finished Goods

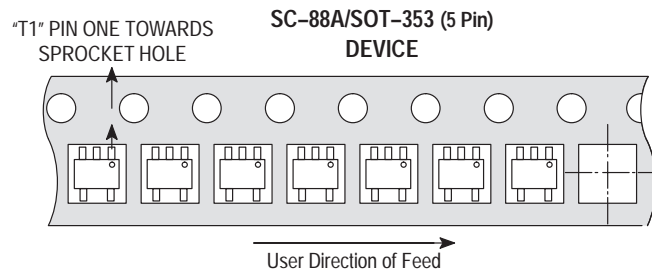



Figure 9. Reel Configuration

ON Semiconductor and  are trademarks of Semiconductor Components Industries, LLC (SCILLC). SCILLC reserves the right to make changes without further notice to any products herein. SCILLC makes no warranty, representation or guarantee regarding the suitability of its products for any particular purpose, nor does SCILLC assume any liability arising out of the application or use of any product or circuit, and specifically disclaims any and all liability, including without limitation special, consequential or incidental damages. "Typical" parameters which may be provided in SCILLC data sheets and/or specifications can and do vary in different applications and actual performance may vary over time. All operating parameters, including "Typicals" must be validated for each customer application by customer's technical experts. SCILLC does not convey any license under its patent rights nor the rights of others. SCILLC products are not designed, intended, or authorized for use as components in systems intended for surgical implant into the body, or other applications intended to support or sustain life, or for any other application in which the failure of the SCILLC product could create a situation where personal injury or death may occur. Should Buyer purchase or use SCILLC products for any such unintended or unauthorized application, Buyer shall indemnify and hold SCILLC and its officers, employees, subsidiaries, affiliates, and distributors harmless against all claims, costs, damages, and expenses, and reasonable attorney fees arising out of, directly or indirectly, any claim of personal injury or death associated with such unintended or unauthorized use, even if such claim alleges that SCILLC was negligent regarding the design or manufacture of the part. SCILLC is an Equal Opportunity/Affirmative Action Employer.

PUBLICATION ORDERING INFORMATION

USA/EUROPE Literature Fulfillment:

Literature Distribution Center for ON Semiconductor
P.O. Box 5163, Denver, Colorado 80217 USA
Phone: 303-675-2175 or 800-344-3860 Toll Free USA/Canada
Fax: 303-675-2176 or 800-344-3867 Toll Free USA/Canada
Email: ONlit@hibbertco.com

Fax Response Line*: 303-675-2167
800-344-3810 Toll Free USA/Canada
*To receive a Fax of our publications

N. America Technical Support: 800-282-9855 Toll Free USA/Canada

ASIA/PACIFIC: LDC for ON Semiconductor – Asia Support

Phone: 303-675-2121 (Tue-Fri 9:00am to 1:00pm, Hong Kong Time)
Email: ONlit-asia@hibbertco.com

JAPAN: ON Semiconductor, Japan Customer Focus Center

4-32-1 Nishi-Gotanda, Shinagawa-ku, Tokyo, Japan 141-8549
Phone: 81-3-5487-8345
Email: r14153@onsemi.com

ON Semiconductor Website: <http://onsemi.com>

For additional information, please contact your local Sales Representative.