



MC74AC257 MC74ACT257

Quad 2-Input Multiplexer with 3-State Outputs

The MC74AC257/74ACT257 is a quad 2-input multiplexer with 3-state outputs. Four bits of data from two sources can be selected using a Common Data Select input. The four outputs present the selected data in true (noninverted) form. The outputs may be switched to a high impedance state by placing a logic HIGH on the common Output Enable (OE) input, allowing the outputs to interface directly with bus-oriented systems.

- Multiplexer Expansion by Tying Outputs Together
- Noninverting 3-State Outputs
- Outputs Source/Sink 24 mA
- 'ACT257 Has TTL Compatible Inputs

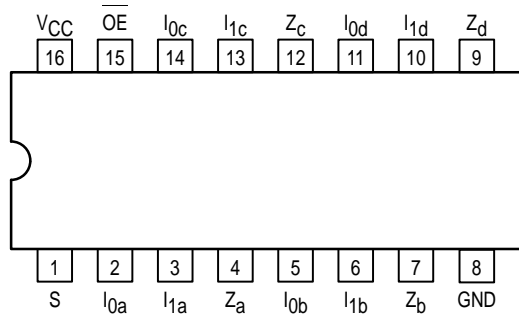

PIN NAMES

- S Common Data Select Input
- OE 3-State Output Enable Input
- $I_{0a}-I_{0d}$ Data Inputs from Source 0
- $I_{1a}-I_{1d}$ Data Inputs from Source 1
- Z_a-Z_d 3-State Multiplexer Outputs

QUAD 2-INPUT
MULTIPLEXER WITH
3-STATE OUTPUTS

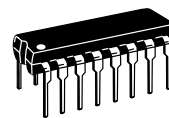

N SUFFIX
CASE 648-08
PLASTIC

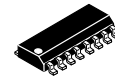

D SUFFIX
CASE 751B-05
PLASTIC

TRUTH TABLE

Output Enable	Select Input	Data Inputs		Outputs
OE	S	I_0	I_1	Z
H	X	X	X	Z
L	H	X	L	L
L	H	X	H	H
L	L	L	X	L
L	L	H	X	H

H = HIGH Voltage Level
L = LOW Voltage Level
X = Immaterial
Z = High Impedance

LOGIC SYMBOL

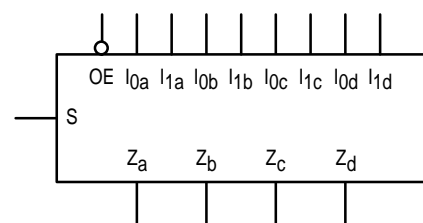

MC74AC257 MC74ACT257

FUNCTIONAL DESCRIPTION

The MC74AC257/74ACT257 is a quad 2-input multiplexer with 3-state outputs. It selects four bits of data from two sources under control of a Common Data Select input. When the Select input is LOW, the I_{0x} inputs are selected and when Select is HIGH, the I_{1x} inputs are selected. The data on the selected inputs appears at the outputs in true (noninverted) form. The device is the logic implementation of a 4-pole, 2-position switch where the position of the switch is determined by the logic levels supplied to the Select input. The logic equations for the outputs are shown below:

$$Z_a = \overline{OE} \cdot (I_{1a} \cdot S + I_{0a} \cdot \overline{S})$$

$$Z_b = \overline{OE} \cdot (I_{1b} \cdot S + I_{0b} \cdot \overline{S})$$

$$Z_c = \overline{OE} \cdot (I_{1c} \cdot S + I_{0c} \cdot \overline{S})$$

$$Z_d = \overline{OE} \cdot (I_{1d} \cdot S + I_{0d} \cdot \overline{S})$$

When the Output Enable input (\overline{OE}) is HIGH, the outputs are forced to a high impedance state. If the outputs are tied together, all but one device must be in the high impedance state to avoid high currents that would exceed the maximum ratings. Designers should ensure the Output Enable signals to 3-state devices whose outputs are tied together are designed so there is no overlap.

LOGIC DIAGRAM

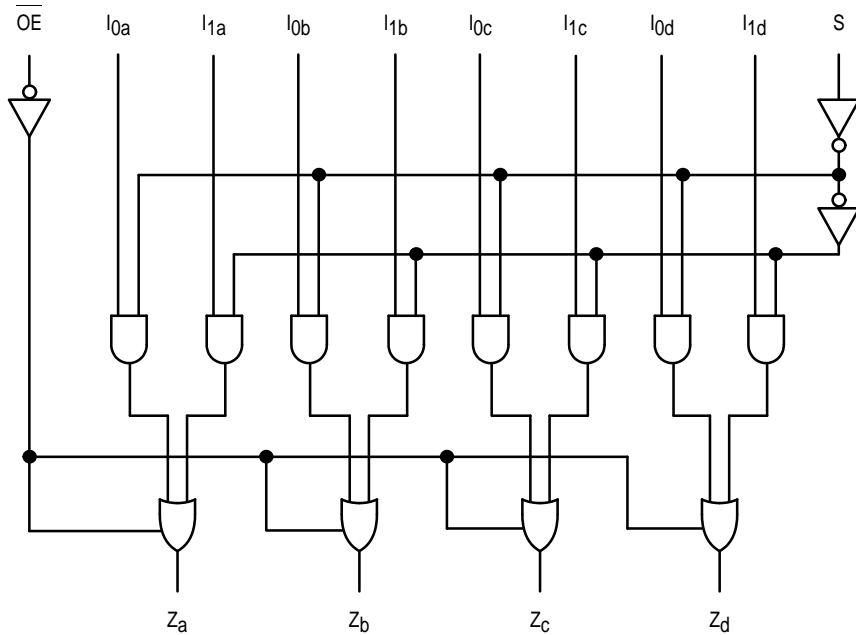

Please note that this diagram is provided only for the understanding of logic operations and should not be used to estimate propagation delays.

MC74AC257 MC74ACT257

MAXIMUM RATINGS*

Symbol	Parameter	Value	Unit
V _{CC}	DC Supply Voltage (Referenced to GND)	-0.5 to +7.0	V
V _{in}	DC Input Voltage (Referenced to GND)	-0.5 to V _{CC} +0.5	V
V _{out}	DC Output Voltage (Referenced to GND)	-0.5 to V _{CC} +0.5	V
I _{in}	DC Input Current, per Pin	±20	mA
I _{out}	DC Output Sink/Source Current, per Pin	±50	mA
I _{CC}	DC V _{CC} or GND Current per Output Pin	±50	mA
T _{stg}	Storage Temperature	-65 to +150	°C

* Maximum Ratings are those values beyond which damage to the device may occur. Functional operation should be restricted to the Recommended Operating Conditions.

RECOMMENDED OPERATING CONDITIONS

Symbol	Parameter	Min	Typ	Max	Unit	
V _{CC}	Supply Voltage	'AC	2.0	5.0	6.0	V
		'ACT	4.5	5.0	5.5	
V _{in} , V _{out}	DC Input Voltage, Output Voltage (Ref. to GND)	0		V _{CC}	V	
t _r , t _f	Input Rise and Fall Time (Note 1) 'AC Devices except Schmitt Inputs	V _{CC} @ 3.0 V		150		ns/V
		V _{CC} @ 4.5 V		40		
		V _{CC} @ 5.5 V		25		
t _r , t _f	Input Rise and Fall Time (Note 2) 'ACT Devices except Schmitt Inputs	V _{CC} @ 4.5 V		10		ns/V
		V _{CC} @ 5.5 V		8.0		
T _J	Junction Temperature (PDIP)			140	°C	
T _A	Operating Ambient Temperature Range	-40	25	85	°C	
I _{OH}	Output Current — High			-24	mA	
I _{OL}	Output Current — Low			24	mA	

1. V_{in} from 30% to 70% V_{CC}; see individual Data Sheets for devices that differ from the typical input rise and fall times.

2. V_{in} from 0.8 V to 2.0 V; see individual Data Sheets for devices that differ from the typical input rise and fall times.

MC74AC257 MC74ACT257

DC CHARACTERISTICS

Symbol	Parameter	V _{CC} (V)	74AC		74AC		Unit	Conditions
			T _A = +25°C		T _A = -40°C to +85°C			
			Typ	Guaranteed Limits				
V _{IH}	Minimum High Level Input Voltage	3.0	1.5	2.1	2.1		V	V _{OUT} = 0.1 V or V _{CC} - 0.1 V
		4.5	2.25	3.15	3.15			
		5.5	2.75	3.85	3.85			
V _{IL}	Maximum Low Level Input Voltage	3.0	1.5	0.9	0.9		V	V _{OUT} = 0.1 V or V _{CC} - 0.1 V
		4.5	2.25	1.35	1.35			
		5.5	2.75	1.65	1.65			
V _{OH}	Minimum High Level Output Voltage	3.0	2.99	2.9	2.9		V	I _{OUT} = -50 μA
		4.5	4.49	4.4	4.4			
		5.5	5.49	5.4	5.4			
		3.0		2.56	2.46		V	*V _{IN} = V _{IL} or V _{IH} -12 mA I _{OH} -24 mA -24 mA
		4.5		3.86	3.76			
		5.5		4.86	4.76			
V _{OL}	Maximum Low Level Output Voltage	3.0	0.002	0.1	0.1		V	I _{OUT} = 50 μA
		4.5	0.001	0.1	0.1			
		5.5	0.001	0.1	0.1			
		3.0		0.36	0.44		V	*V _{IN} = V _{IL} or V _{IH} 12 mA I _{OL} 24 mA 24 mA
		4.5		0.36	0.44			
		5.5		0.36	0.44			
I _{IN}	Maximum Input Leakage Current	5.5		±0.1	±1.0		μA	V _I = V _{CC} , GND
I _{OZ}	Maximum 3-State Current	5.5		±0.5	±5.0		μA	V _I (OE) = V _{IL} , V _{IH} V _I = V _{CC} , GND V _O = V _{CC} , GND
I _{OLD}	†Minimum Dynamic Output Current	5.5			75		mA	V _{OLD} = 1.65 V Max
I _{OHD}		5.5			-75		mA	V _{OHD} = 3.85 V Min
I _{CC}	Maximum Quiescent Supply Current	5.5		8.0	80		μA	V _{IN} = V _{CC} or GND

* All outputs loaded; thresholds on input associated with output under test.

† Maximum test duration 2.0 ms, one output loaded at a time.

Note: I_{IN} and I_{CC} @ 3.0 V are guaranteed to be less than or equal to the respective limit @ 5.5 V V_{CC}.

MC74AC257 MC74ACT257

AC CHARACTERISTICS (For Figures and Waveforms — See Section 3)

Symbol	Parameter	V _{CC} * (V)	74AC			74AC		Unit	Fig. No.
			T _A = +25°C C _L = 50 pF			T _A = -40°C to +85°C C _L = 50 pF			
			Min	Typ	Max	Min	Max		
t _{PLH}	Propagation Delay I _n to Z _n	3.3 5.0	1.5 1.5	5.0 4.0	8.5 6.0	1.0 1.0	9.0 7.0	ns	3-5
t _{PHL}	Propagation Delay I _n to Z _n	3.3 5.0	1.5 1.5	6.0 4.5	8.5 6.0	1.0 1.0	9.0 7.0	ns	3-5
t _{PLH}	Propagation Delay S to Z _n	3.3 5.0	1.5 1.5	7.0 5.0	10.5 7.5	1.5 1.0	11.5 8.5	ns	3-6
t _{PHL}	Propagation Delay S to Z _n	3.3 5.0	1.5 1.5	7.5 5.5	10.5 7.5	1.5 1.0	11.5 8.5	ns	3-6
t _{PZH}	Output Enable Time	3.3 5.0	1.5 1.5	6.5 5.0	9.5 7.5	1.0 1.0	10.5 8.5	ns	3-7
t _{PZL}	Output Enable Time	3.3 5.0	1.5 1.5	5.5 5.0	9.0 8.5	1.0 1.0	10.0 9.5	ns	3-8
t _{PHZ}	Output Disable Time	3.3 5.0	1.5 1.5	5.5 5.0	10.0 9.0	1.0 1.0	11.0 10.0	ns	3-7
t _{PLZ}	Output Disable Time	3.3 5.0	1.5 1.5	5.5 5.0	9.0 8.0	1.0 1.0	10.0 9.0	ns	3-8

* Voltage Range 3.3 V is 3.3 V ±0.3 V.
Voltage Range 5.0 V is 5.0 V ±0.5 V.

MC74AC257 MC74ACT257

DC CHARACTERISTICS

Symbol	Parameter	V _{CC} (V)	74ACT		74ACT		Unit	Conditions
			T _A = +25°C		T _A = -40°C to +85°C			
			Typ	Guaranteed Limits				
V _{IH}	Minimum High Level Input Voltage	4.5	1.5	2.0	2.0	V	V _{OUT} = 0.1 V or V _{CC} - 0.1 V	
		5.5	1.5	2.0	2.0			
V _{IL}	Maximum Low Level Input Voltage	4.5	1.5	0.8	0.8	V	V _{OUT} = 0.1 V or V _{CC} - 0.1 V	
		5.5	1.5	0.8	0.8			
V _{OH}	Minimum High Level Output Voltage	4.5	4.49	4.4	4.4	V	I _{OUT} = -50 μA	
		5.5	5.49	5.4	5.4			
		4.5		3.86	3.76	V	*V _{IN} = V _{IL} or V _{IH} -24 mA I _{OH} -24 mA	
		5.5		4.86	4.76			
V _{OL}	Maximum Low Level Output Voltage	4.5	0.001	0.1	0.1	V	I _{OUT} = 50 μA	
		5.5	0.001	0.1	0.1			
		4.5		0.36	0.44	V	*V _{IN} = V _{IL} or V _{IH} 24 mA I _{OL} 24 mA	
		5.5		0.36	0.44			
I _{IN}	Maximum Input Leakage Current	5.5		±0.1	±1.0	μA	V _I = V _{CC} , GND	
ΔI _{CCT}	Additional Max. I _{CC} /Input	5.5	0.6		1.5	mA	V _I = V _{CC} - 2.1 V	
I _{OZ}	Maximum 3-State Current	5.5		±0.5	±5.0	μA	V _I (OE) = V _{IL} , V _{IH} V _I = V _{CC} , GND V _O = V _{CC} , GND	
I _{OLD}	†Minimum Dynamic Output Current	5.5			75	mA	V _{OLD} = 1.65 V Max	
I _{OHD}		5.5			-75	mA	V _{OHD} = 3.85 V Min	
I _{CC}	Maximum Quiescent Supply Current	5.5		8.0	80	μA	V _{IN} = V _{CC} or GND	

* All outputs loaded; thresholds on input associated with output under test.

† Maximum test duration 2.0 ms, one output loaded at a time.

MC74AC257 MC74ACT257

AC CHARACTERISTICS (For Figures and Waveforms — See Section 3)

Symbol	Parameter	V _{CC} * (V)	74ACT			74ACT		Unit	Fig. No.
			T _A = +25°C C _L = 50 pF			T _A = -40°C to +85°C C _L = 50 pF			
			Min	Typ	Max	Min	Max		
t _{PLH}	Propagation Delay I _n to Z _n	5.0	1.5	5.0	7.0	1.0	7.5	ns	3-6
t _{PHL}	Propagation Delay I _n to Z _n	5.0	2.0	6.0	7.5	1.5	8.5	ns	3-6
t _{PLH}	Propagation Delay S to Z _n	5.0	2.0	7.0	9.5	1.5	10.5	ns	3-6
t _{PHL}	Propagation Delay S to Z _n	5.0	2.5	7.0	10.5	2.0	11.5	ns	3-6
t _{PZH}	Output Enable Time	5.0	2.0	6.0	8.0	1.5	9.0	ns	3-7
t _{PZL}	Output Enable Time	5.0	2.0	6.0	8.0	1.5	9.0	ns	3-8
t _{PHZ}	Output Disable Time	5.0	2.5	6.5	9.0	1.5	10.0	ns	3-7
t _{PLZ}	Output Disable Time	5.0	2.0	6.0	7.5	1.5	8.5	ns	3-8

* Voltage Range 5.0 V is 5.0 V ± 0.5 V.

CAPACITANCE

Symbol	Parameter	Value Typ	Unit	Test Conditions
C _{IN}	Input Capacitance	4.5	pF	V _{CC} = 5.0 V
CPD	Power Dissipation Capacitance	50	pF	V _{CC} = 5.0 V

MC74AC257 MC74ACT257

OUTLINE DIMENSIONS

N SUFFIX PLASTIC DIP PACKAGE CASE 648-08 ISSUE R

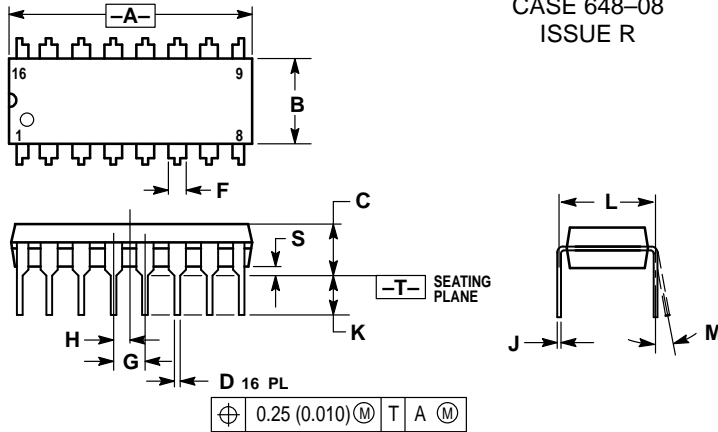

- NOTES:
1. DIMENSIONING AND TOLERANCING PER ANSI Y14.5M, 1982.
 2. CONTROLLING DIMENSION: INCH.
 3. DIMENSION L TO CENTER OF LEADS WHEN FORMED PARALLEL.
 4. DIMENSION B DOES NOT INCLUDE MOLD FLASH.
 5. ROUNDED CORNERS OPTIONAL.

DIM	INCHES		MILLIMETERS	
	MIN	MAX	MIN	MAX
A	0.740	0.770	18.80	19.55
B	0.250	0.270	6.35	6.85
C	0.145	0.175	3.69	4.44
D	0.015	0.021	0.39	0.53
F	0.040	0.70	1.02	1.77
G	0.100 BSC		2.54 BSC	
H	0.050 BSC		1.27 BSC	
J	0.008	0.015	0.21	0.38
K	0.110	0.130	2.80	3.30
L	0.295	0.305	7.50	7.74
M	0°	10°	0°	10°
S	0.020	0.040	0.51	1.01

D SUFFIX PLASTIC SOIC PACKAGE CASE 751B-05 ISSUE J

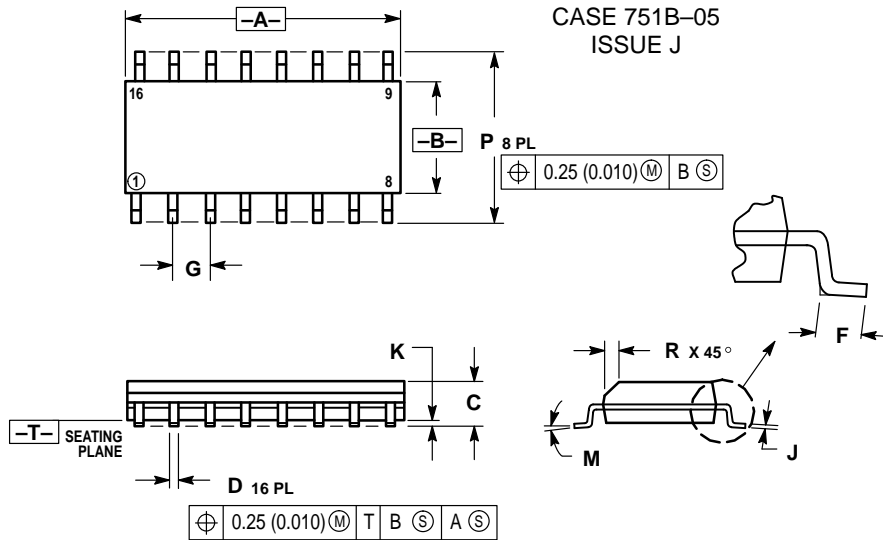

- NOTES:
1. DIMENSIONING AND TOLERANCING PER ANSI Y14.5M, 1982.
 2. CONTROLLING DIMENSION: MILLIMETER.
 3. DIMENSIONS A AND B DO NOT INCLUDE MOLD PROTRUSION.
 4. MAXIMUM MOLD PROTRUSION 0.15 (0.006) PER SIDE.
 5. DIMENSION D DOES NOT INCLUDE DAMBAR PROTRUSION. ALLOWABLE DAMBAR PROTRUSION SHALL BE 0.127 (0.005) TOTAL IN EXCESS OF THE D DIMENSION AT MAXIMUM MATERIAL CONDITION.

DIM	MILLIMETERS		INCHES	
	MIN	MAX	MIN	MAX
A	9.80	10.00	0.386	0.393
B	3.80	4.00	0.150	0.157
C	1.35	1.75	0.054	0.068
D	0.35	0.49	0.014	0.019
F	0.40	1.25	0.016	0.049
G	1.27 BSC		0.050 BSC	
J	0.19	0.25	0.008	0.009
K	0.10	0.25	0.004	0.009
M	0°	7°	0°	7°
P	5.80	6.20	0.229	0.244
R	0.25	0.50	0.010	0.019

Motorola reserves the right to make changes without further notice to any products herein. Motorola makes no warranty, representation or guarantee regarding the suitability of its products for any particular purpose, nor does Motorola assume any liability arising out of the application or use of any product or circuit, and specifically disclaims any and all liability, including without limitation consequential or incidental damages. "Typical" parameters can and do vary in different applications. All operating parameters, including "Typicals" must be validated for each customer application by customer's technical experts. Motorola does not convey any license under its patent rights nor the rights of others. Motorola products are not designed, intended, or authorized for use as components in systems intended for surgical implant into the body, or other applications intended to support or sustain life, or for any other application in which the failure of the Motorola product could create a situation where personal injury or death may occur. Should Buyer purchase or use Motorola products for any such unintended or unauthorized application, Buyer shall indemnify and hold Motorola and its officers, employees, subsidiaries, affiliates, and distributors harmless against all claims, costs, damages, and expenses, and reasonable attorney fees arising out of, directly or indirectly, any claim of personal injury or death associated with such unintended or unauthorized use, even if such claim alleges that Motorola was negligent regarding the design or manufacture of the part. Motorola and  are registered trademarks of Motorola, Inc. Motorola, Inc. is an Equal Opportunity/Affirmative Action Employer.

How to reach us:

USA/EUROPE: Motorola Literature Distribution;
P.O. Box 20912; Phoenix, Arizona 85036. 1-800-441-2447

JAPAN: Nippon Motorola Ltd.; Tatsumi-SPD-JLDC, Toshikatsu Otsuki,
6F Seibu-Butsuryu-Center, 3-14-2 Tatsumi Koto-Ku, Tokyo 135, Japan. 03-3521-8315

MFAX: RMFA00@email.sps.mot.com -TOUCHTONE (602) 244-6609
INTERNET: <http://Design-NET.com>

HONG KONG: Motorola Semiconductors H.K. Ltd.; 8B Tai Ping Industrial Park,
51 Ting Kok Road, Tai Po, N.T., Hong Kong. 852-26629298



MC74AC257/D

