

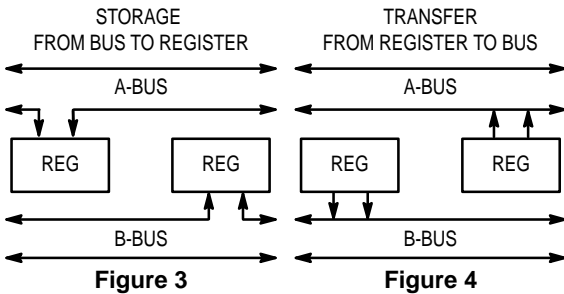

Product Preview

# Octal Transceiver/Register with 3-State Outputs (Inverting)

The MC74AC648/74ACT648 consist of registered bus transceiver circuits, with outputs, D-type flip-flops and control circuitry providing multiplexed transmission of data directly from the input bus or from the internal storage registers. Data on the A or B bus will be loaded into the respective registers on the LOW-to-HIGH transition of the appropriate clock pin (CAB or CBA). The four fundamental data handling functions available are illustrated in the following figures.

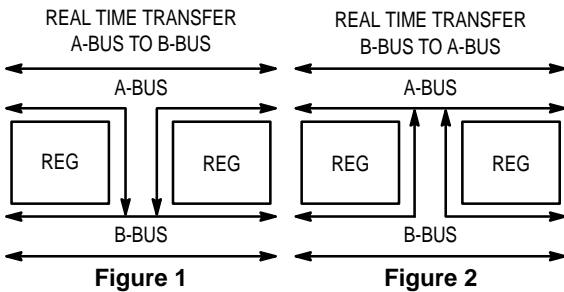

- Independent Registers for A and B Buses
- Multiplexed Real-Time and Stored Data Transfers
- Choice of True and Inverting Data Paths
- 3-State Outputs
- 300 mil Slim Dual In-Line Package
- Outputs Source/Sink 24 mA

**MC74AC648**  
**MC74ACT648**

OCTAL  
TRANSCEIVER/REGISTER  
WITH 3-STATE OUTPUTS  
(INVERTING)

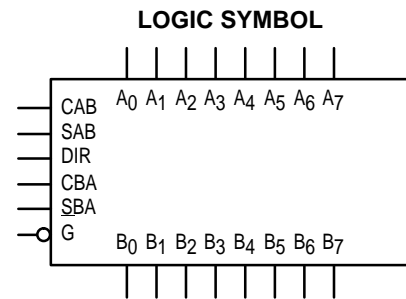
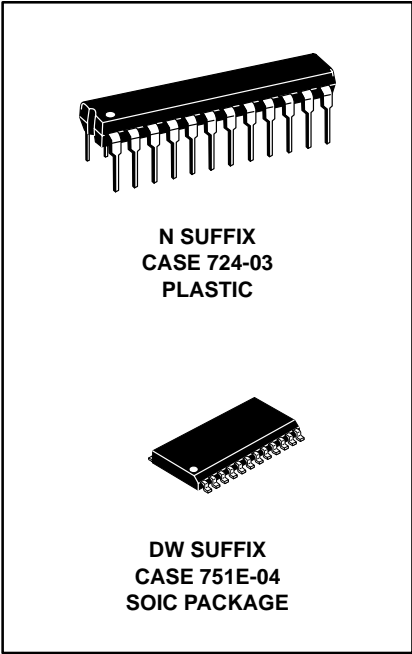

This document contains information on a product under development. Motorola reserves the right to change or discontinue this product without notice.

# MC74AC648 MC74ACT648

## FUNCTION TABLE

Inputs						Data I/O*		Operation or Function
G	DIR	CAB	CBA	SAB	SBA	A <sub>0</sub> -A <sub>7</sub>	B <sub>0</sub> -B <sub>7</sub>	
H	X	H or L	H or L	X	X	Input	Input	Isolation Store A and B Data
H	X	┐	┐	X	X			
L	L	X	X	X	L	Output	Input	Real Time B Data to A Bus Stored B Data to A Bus
L	L	X	X	X	H			
L	H	X	X	L	X	Input	Output	Real Time A Data to B Bus Stored A Data to B Bus
L	H	H or L	X	H	X			

\* The data output functions may be enabled or disabled by various signals at the G and DIR inputs. Data input functions are always enabled; i.e., data at the bus pins will be stored on every LOW-to-HIGH transition of the appropriate clock inputs.

H = HIGH Voltage Level

L = LOW Voltage Level

X = Immaterial

┐ = LOW-to-HIGH Transition

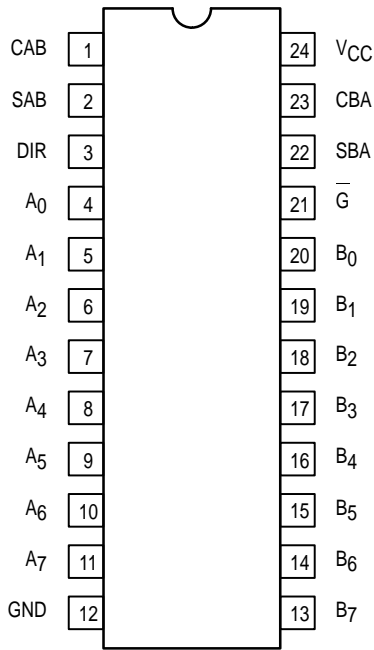

### PIN NAMES

A<sub>0</sub>-A<sub>7</sub> Data Register Inputs  
Data Register A Outputs  
B<sub>0</sub>-B<sub>7</sub> Data Register B Inputs  
Data Register B Outputs  
CAB, CBA Clock Pulse Inputs  
SAB, SBA Transmit/Receive Inputs  
DIR, G Output Enable Inputs

## LOGIC DIAGRAM

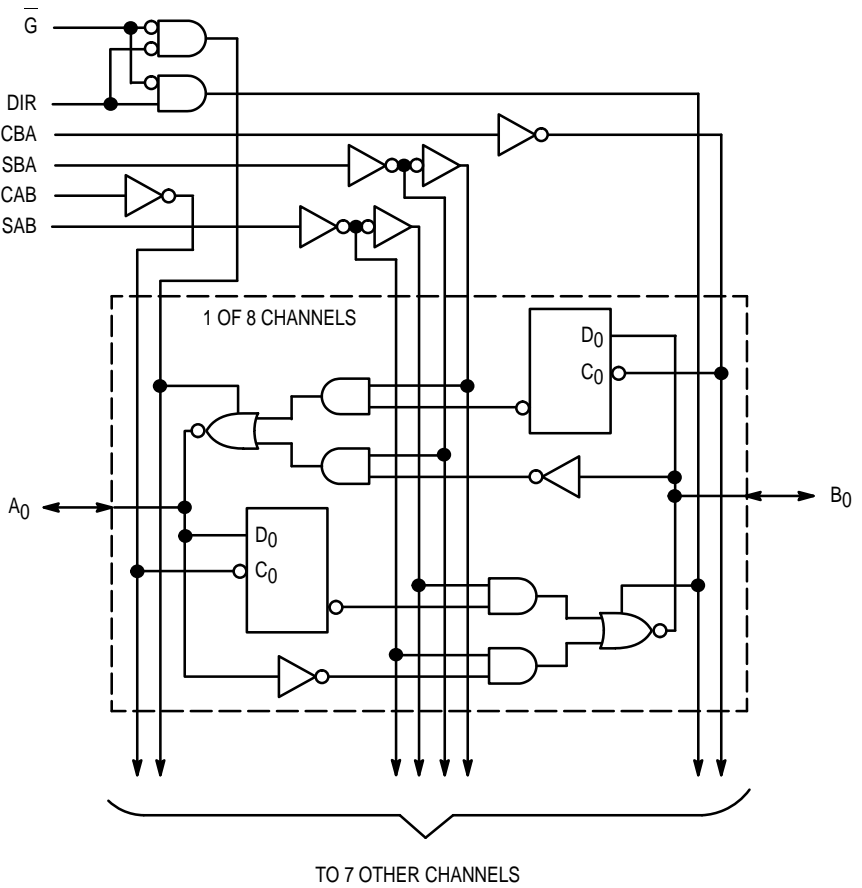

Please note that this diagram is provided only for the understanding of logic operations and should not be used to estimate propagation delays.

# MC74AC648 MC74ACT648

## MAXIMUM RATINGS\*

Symbol	Parameter	Value	Unit
V <sub>CC</sub>	DC Supply Voltage (Referenced to GND)	-0.5 to +7.0	V
V <sub>in</sub>	DC Input Voltage (Referenced to GND)	-0.5 to V <sub>CC</sub> +0.5	V
V <sub>out</sub>	DC Output Voltage (Referenced to GND)	-0.5 to V <sub>CC</sub> +0.5	V
I <sub>in</sub>	DC Input Current, per Pin	±20	mA
I <sub>out</sub>	DC Output Sink/Source Current, per Pin	±50	mA
I <sub>CC</sub>	DC V <sub>CC</sub> or GND Current per Output Pin	±50	mA
T <sub>stg</sub>	Storage Temperature	-65 to +150	°C

\* Maximum Ratings are those values beyond which damage to the device may occur. Functional operation should be restricted to the Recommended Operating Conditions.

## RECOMMENDED OPERATING CONDITIONS

Symbol	Parameter	Min	Typ	Max	Unit	
V <sub>CC</sub>	Supply Voltage	'AC	2.0	5.0	6.0	V
		'ACT	4.5	5.0	5.5	
V <sub>in</sub> , V <sub>out</sub>	DC Input Voltage, Output Voltage (Ref. to GND)	0		V <sub>CC</sub>	V	
t <sub>r</sub> , t <sub>f</sub>	Input Rise and Fall Time (Note 1) 'AC Devices except Schmitt Inputs	V <sub>CC</sub> @ 3.0 V		150		ns/V
		V <sub>CC</sub> @ 4.5 V		40		
		V <sub>CC</sub> @ 5.5 V		25		
t <sub>r</sub> , t <sub>f</sub>	Input Rise and Fall Time (Note 2) 'ACT Devices except Schmitt Inputs	V <sub>CC</sub> @ 4.5 V		10		ns/V
		V <sub>CC</sub> @ 5.5 V		8.0		
T <sub>J</sub>	Junction Temperature (PDIP)			140	°C	
T <sub>A</sub>	Operating Ambient Temperature Range	-40	25	85	°C	
I <sub>OH</sub>	Output Current — High			-24	mA	
I <sub>OL</sub>	Output Current — Low			24	mA	

1. V<sub>in</sub> from 30% to 70% V<sub>CC</sub>; see individual Data Sheets for devices that differ from the typical input rise and fall times.

2. V<sub>in</sub> from 0.8 V to 2.0 V; see individual Data Sheets for devices that differ from the typical input rise and fall times.

# MC74AC648 MC74ACT648

## DC CHARACTERISTICS

Symbol	Parameter	V <sub>CC</sub> (V)	74AC		74AC		Unit	Conditions
			T <sub>A</sub> = +25°C		T <sub>A</sub> = -40°C to +85°C			
			Typ	Guaranteed Limits				
V <sub>IH</sub>	Minimum High Level Input Voltage	3.0	1.5	2.1	2.1	V	V <sub>OUT</sub> = 0.1 V or V <sub>CC</sub> - 0.1 V	
		4.5	2.25	3.15	3.15			
		5.5	2.75	3.85	3.85			
V <sub>IL</sub>	Maximum Low Level Input Voltage	3.0	1.5	0.9	0.9	V	V <sub>OUT</sub> = 0.1 V or V <sub>CC</sub> - 0.1 V	
		4.5	2.25	1.35	1.35			
		5.5	2.75	1.65	1.65			
V <sub>OH</sub>	Minimum High Level Output Voltage	3.0	2.99	2.9	2.9	V	I <sub>OUT</sub> = -50 μA	
		4.5	4.49	4.4	4.4			
		5.5	5.49	5.4	5.4			
		3.0		2.56	2.46	V	*V <sub>IN</sub> = V <sub>IL</sub> or V <sub>IH</sub> -12 mA I <sub>OH</sub> -24 mA -24 mA	
		4.5		3.86	3.76			
		5.5		4.86	4.76			
V <sub>OL</sub>	Maximum Low Level Output Voltage	3.0	0.002	0.1	0.1	V	I <sub>OUT</sub> = 50 μA	
		4.5	0.001	0.1	0.1			
		5.5	0.001	0.1	0.1			
		3.0		0.36	0.44	V	*V <sub>IN</sub> = V <sub>IL</sub> or V <sub>IH</sub> 12 mA I <sub>OL</sub> 24 mA 24 mA	
		4.5		0.36	0.44			
		5.5		0.36	0.44			
I <sub>IN</sub>	Maximum Input Leakage Current	5.5		±0.1	±1.0	μA	V <sub>I</sub> = V <sub>CC</sub> , GND	
I <sub>OZT</sub>	Maximum 3-State Current	5.5		±0.6	±6.0	μA	V <sub>I</sub> (OE) = V <sub>IL</sub> , V <sub>IH</sub> V <sub>I</sub> = V <sub>CC</sub> , GND V <sub>O</sub> = V <sub>CC</sub> , GND	
I <sub>OLD</sub>	†Minimum Dynamic Output Current	5.5			75	mA	V <sub>OLD</sub> = 1.65 V Max	
I <sub>OHD</sub>		5.5			-75	mA	V <sub>OHD</sub> = 3.85 V Min	
I <sub>CC</sub>	Maximum Quiescent Supply Current	5.5		8.0	80	μA	V <sub>IN</sub> = V <sub>CC</sub> or GND	

\* All outputs loaded; thresholds on input associated with output under test.

† Maximum test duration 2.0 ms, one output loaded at a time.

Note: I<sub>IN</sub> and I<sub>CC</sub> @ 3.0 V are guaranteed to be less than or equal to the respective limit @ 5.5 V V<sub>CC</sub>.

# MC74AC648 MC74ACT648

## AC CHARACTERISTICS (For Figures and Waveforms — See Section 3)

Symbol	Parameter	V <sub>CC</sub> * (V)	74AC			74AC		Unit	Fig. No.
			T <sub>A</sub> = +25°C C <sub>L</sub> = 50 pF			T <sub>A</sub> = -40°C to +85°C C <sub>L</sub> = 50 pF			
			Min	Typ	Max	Min	Max		
t <sub>PLH</sub>	Propagation Delay Clock to Bus	3.3 5.0	1.5 1.5	10 7.0	15.5 11	1.5 1.5	17 12	ns	3-6
t <sub>PHL</sub>	Propagation Delay Clock to Bus	3.3 5.0	1.5 1.5	8.5 6.0	13.5 10.5	1.5 1.5	14.5 11.5	ns	3-6
t <sub>PLH</sub>	Propagation Delay Bus to Bus	3.3 5.0	1.5 1.5	6.0 4.0	10 7.0	1.5 1.0	11 7.5	ns	3-5
t <sub>PHL</sub>	Propagation Delay Bus to Bus	3.3 5.0	1.5 1.5	5.5 3.5	9.0 7.5	1.5 1.0	10 8.0	ns	3-5
t <sub>PLH</sub>	Propagation Delay SBA or SAB to A <sub>n</sub> or B <sub>n</sub> (w/A <sub>n</sub> or B <sub>n</sub> HIGH or LOW)	3.3 5.0	1.5 1.5	7.5 5.5	12.5 9.0	1.5 1.5	14 10	ns	3-6
t <sub>PHL</sub>	Propagation Delay SBA or SAB to A <sub>n</sub> or B <sub>n</sub> (w/A <sub>n</sub> or B <sub>n</sub> HIGH or LOW)	3.3 5.0	1.5 1.5	7.5 5.5	12.5 9.5	1.5 1.5	14 10.5	ns	3-6
t <sub>PZH</sub>	Enable Time G to A <sub>n</sub> or B <sub>n</sub>	3.3 5.0	1.5 1.5	6.5 5.0	11 8.0	1.0 1.0	11.5 9.0	ns	3-7
t <sub>PZL</sub>	Enable Time G to A <sub>n</sub> or B <sub>n</sub>	3.3 5.0	1.5 1.5	7.0 5.0	11 8.0	1.0 1.0	12.5 9.0	ns	3-8
t <sub>PHZ</sub>	Disable Time G to A <sub>n</sub> or B <sub>n</sub>	3.3 5.0	1.5 1.5	7.5 6.0	12 10	1.0 1.0	13 11	ns	3-7
t <sub>PLZ</sub>	Disable Time G to A <sub>n</sub> or B <sub>n</sub>	3.3 5.0	1.5 1.5	7.0 5.5	11.5 9.0	1.0 1.0	12.5 10	ns	3-8
t <sub>PZH</sub>	Enable Time DIR to A <sub>n</sub> or B <sub>n</sub>	3.3 5.0	1.5 1.5	6.0 4.5	12.5 9.5	1.0 1.0	14 10.5	ns	3-7
t <sub>PZL</sub>	Enable Time DIR to A <sub>n</sub> or B <sub>n</sub>	3.3 5.0	1.5 1.5	6.5 4.5	13 9.0	1.5 1.0	14.5 10.5	ns	3-8
t <sub>PHZ</sub>	Disable Time DIR to A <sub>n</sub> or B <sub>n</sub>	3.3 5.0	1.5 1.5	7.0 5.5	11.5 9.0	1.0 1.0	13.5 10	ns	3-7
t <sub>PLZ</sub>	Disable Time DIR to A <sub>n</sub> or B <sub>n</sub>	3.3 5.0	1.5 1.5	7.0 5.0	13.5 9.5	1.5 1.0	15 10	ns	3-8

\* Voltage Range 3.3 V is 3.3 V ±0.3 V.  
Voltage Range 5.0 V is 5.0 V ±0.5 V.

# MC74AC648 MC74ACT648

## AC OPERATING REQUIREMENTS

Symbol	Parameter	V <sub>CC</sub> * (V)	74AC		74AC		Unit	Fig. No.
			T <sub>A</sub> = +25°C C <sub>L</sub> = 50 pF		T <sub>A</sub> = -40°C to +85°C C <sub>L</sub> = 50 pF			
			Typ	Guaranteed Minimum				
t <sub>s</sub>	Setup Time, HIGH or LOW Bus to Clock	3.3	2.0	3.0	3.5	ns	3-9	
		5.0	1.5	2.0	2.0			
t <sub>h</sub>	Hold Time, HIGH or LOW Bus to Clock	3.3	-1.5	0	0	ns	3-9	
		5.0	-0.5	1.0	1.0			
t <sub>w</sub>	Clock Pulse Width HIGH or LOW	3.3	2.0	3.5	4.0	ns	3-6	
		5.0	2.0	3.0	3.0			

\* Voltage Range 3.3 V is 3.3 V ±0.3 V.  
Voltage Range 5.0 V is 5.0 V ±0.5 V.

## DC CHARACTERISTICS

Symbol	Parameter	V <sub>CC</sub> (V)	74ACT		74ACT		Unit	Conditions
			T <sub>A</sub> = +25°C		T <sub>A</sub> = -40°C to +85°C			
			Typ	Guaranteed Limits				
V <sub>IH</sub>	Minimum High Level Input Voltage	4.5	1.5	2.0	2.0	V	V <sub>OUT</sub> = 0.1 V or V <sub>CC</sub> - 0.1 V	
		5.5	1.5	2.0	2.0			
V <sub>IL</sub>	Maximum Low Level Input Voltage	4.5	1.5	0.8	0.8	V	V <sub>OUT</sub> = 0.1 V or V <sub>CC</sub> - 0.1 V	
		5.5	1.5	0.8	0.8			
V <sub>OH</sub>	Minimum High Level Output Voltage	4.5	4.49	4.4	4.4	V	I <sub>OUT</sub> = -50 μA	
		5.5	5.49	5.4	5.4			
		4.5		3.86	3.76	V	*V <sub>IN</sub> = V <sub>IL</sub> or V <sub>IH</sub> -24 mA I <sub>OH</sub> -24 mA	
V <sub>OL</sub>	Maximum Low Level Output Voltage	4.5	0.001	0.1	0.1	V	I <sub>OUT</sub> = 50 μA	
		5.5	0.001	0.1	0.1			
		4.5		0.36	0.44	V	*V <sub>IN</sub> = V <sub>IL</sub> or V <sub>IH</sub> 24 mA I <sub>OL</sub> 24 mA	
I <sub>IN</sub>	Maximum Input Leakage Current	5.5		±0.1	±1.0	μA	V <sub>I</sub> = V <sub>CC</sub> , GND	
ΔI <sub>CCT</sub>	Additional Max. I <sub>CC</sub> /Input	5.5	0.6		1.5	mA	V <sub>I</sub> = V <sub>CC</sub> - 2.1 V	
I <sub>OZT</sub>	Maximum 3-State Current	5.5		±0.6	±6.0	μA	V <sub>I</sub> (OE) = V <sub>IL</sub> , V <sub>IH</sub> V <sub>I</sub> = V <sub>CC</sub> , GND V <sub>O</sub> = V <sub>CC</sub> , GND	
I <sub>OLD</sub>	†Minimum Dynamic Output Current	5.5			75	mA	V <sub>OLD</sub> = 1.65 V Max	
I <sub>OHD</sub>		5.5			-75	mA	V <sub>OHD</sub> = 3.85 V Min	
I <sub>CC</sub>	Maximum Quiescent Supply Current	5.5		8.0	80	μA	V <sub>IN</sub> = V <sub>CC</sub> or GND	

\* All outputs loaded; thresholds on input associated with output under test.

† Maximum test duration 2.0 ms, one output loaded at a time.

# MC74AC648 MC74ACT648

## AC CHARACTERISTICS (For Figures and Waveforms — See Section 3)

Symbol	Parameter	V <sub>CC</sub> * (V)	74ACT			74ACT		Unit	Fig. No.
			T <sub>A</sub> = +25°C C <sub>L</sub> = 50 pF			T <sub>A</sub> = -40°C to +85°C C <sub>L</sub> = 50 pF			
			Min	Typ	Max	Min	Max		
t <sub>PLH</sub>	Propagation Delay Clock to Bus	5.0	1.5		14.0	1.5	15.5	ns	3-6
t <sub>PHL</sub>	Propagation Delay Clock to Bus	5.0	1.5		14.0	1.5	15.5	ns	3-6
t <sub>PLH</sub>	Propagation Delay Bus to Bus	5.0	1.5		11.5	1.0	13.0	ns	3-5
t <sub>PHL</sub>	Propagation Delay Bus to Bus	5.0	1.5		11.5	1.0	13.0	ns	3-5
t <sub>PLH</sub>	Propagation Delay SBA or SAB to A <sub>n</sub> or B <sub>n</sub> (w/A <sub>n</sub> or B <sub>n</sub> HIGH or LOW)	5.0	1.5		12.0	1.5	14.0	ns	3-6
t <sub>PHL</sub>	Propagation Delay SBA or SAB to A <sub>n</sub> or B <sub>n</sub> (w/A <sub>n</sub> or B <sub>n</sub> HIGH or LOW)	5.0	1.5		12.0	1.5	14.0	ns	3-6
t <sub>PZH</sub>	Enable Time G to A <sub>n</sub> or B <sub>n</sub>	5.0	1.5		11.0	1.0	12.5	ns	3-7
t <sub>PZL</sub>	Enable Time G to A <sub>n</sub> or B <sub>n</sub>	5.0	1.5		11.5	1.0	13.0	ns	3-8
t <sub>PHZ</sub>	Disable Time G to A <sub>n</sub> or B <sub>n</sub>	5.0	1.5		12.5	1.0	14.0	ns	3-7
t <sub>PLZ</sub>	Disable Time G to A <sub>n</sub> or B <sub>n</sub>	5.0	1.5		12.0	1.0	13.5	ns	3-8
t <sub>PZH</sub>	Enable Time DIR to A <sub>n</sub> or B <sub>n</sub>	5.0	1.5		13.0	1.0	14.5	ns	3-7
t <sub>PZL</sub>	Enable Time DIR to A <sub>n</sub> or B <sub>n</sub>	5.0	1.5		12.0	1.0	13.5	ns	3-8
t <sub>PHZ</sub>	Disable Time DIR to A <sub>n</sub> or B <sub>n</sub>	5.0	1.5		11.5	1.0	13.0	ns	3-7
t <sub>PLZ</sub>	Disable Time DIR to A <sub>n</sub> or B <sub>n</sub>	5.0	1.5		11.0	1.0	12.5	ns	3-8

\* Voltage Range 5.0 V is 5.0 V ±0.5 V.

# MC74AC648 MC74ACT648

## AC OPERATING REQUIREMENTS

Symbol	Parameter	V <sub>CC</sub> * (V)	74ACT		Unit	Fig. No.	
			74ACT				
			T <sub>A</sub> = +25°C C <sub>L</sub> = 50 pF	T <sub>A</sub> = -40°C to +85°C C <sub>L</sub> = 50 pF			
Typ	Guaranteed Minimum						
t <sub>s</sub>	Setup Time, HIGH or LOW Bus to Clock	5.0		4.0	5.0	ns	3-9
t <sub>h</sub>	Hold Time, HIGH or LOW Bus to Clock	5.0		2.0	3.0	ns	3-9
t <sub>w</sub>	Clock Pulse Width HIGH or LOW	5.0		5.0	6.0	ns	3-6

\* Voltage Range 5.0 V is 5.0 V ±0.5 V.

## CAPACITANCE

Symbol	Parameter	Value Typ	Unit	Test Conditions
C <sub>IN</sub>	Input Capacitance	4.5	pF	V <sub>CC</sub> = 5.0 V
C <sub>I/O</sub>	Input/Output Capacitance	15	pF	V <sub>CC</sub> = 5.0 V
C <sub>PD</sub>	Power Dissipation Capacitance	65	pF	V <sub>CC</sub> = 5.0 V



# MC74AC648 MC74ACT648

## OUTLINE DIMENSIONS

### N SUFFIX PLASTIC DIP PACKAGE CASE 724-03 ISSUE D

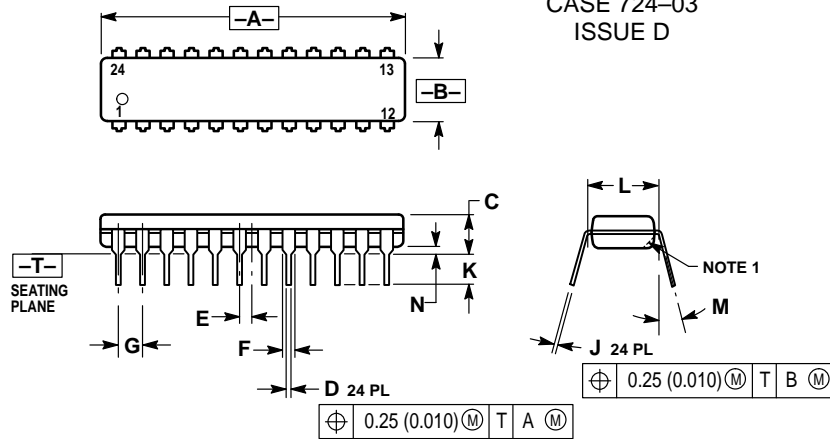

- NOTES:
1. CHAMFERED CONTOUR OPTIONAL.
  2. DIMENSION L TO CENTER OF LEADS WHEN FORMED PARALLEL.
  3. DIMENSIONING AND TOLERANCING PER ANSI Y14.5M, 1982.
  4. CONTROLLING DIMENSION: INCH.

DIM	INCHES		MILLIMETERS	
	MIN	MAX	MIN	MAX
A	1.230	1.285	31.25	32.13
B	0.250	0.270	6.35	6.85
C	0.145	0.175	3.69	4.44
D	0.015	0.020	0.38	0.51
E	0.050 BSC		1.27 BSC	
F	0.040	0.060	1.02	1.52
G	0.100 BSC		2.54 BSC	
J	0.007	0.012	0.18	0.30
K	0.110	0.140	2.80	3.55
L	0.300 BSC		7.62 BSC	
M	0°	15°	0°	15°
N	0.020	0.040	0.51	1.01

### DW SUFFIX PLASTIC SOIC PACKAGE CASE 751E-04 ISSUE E

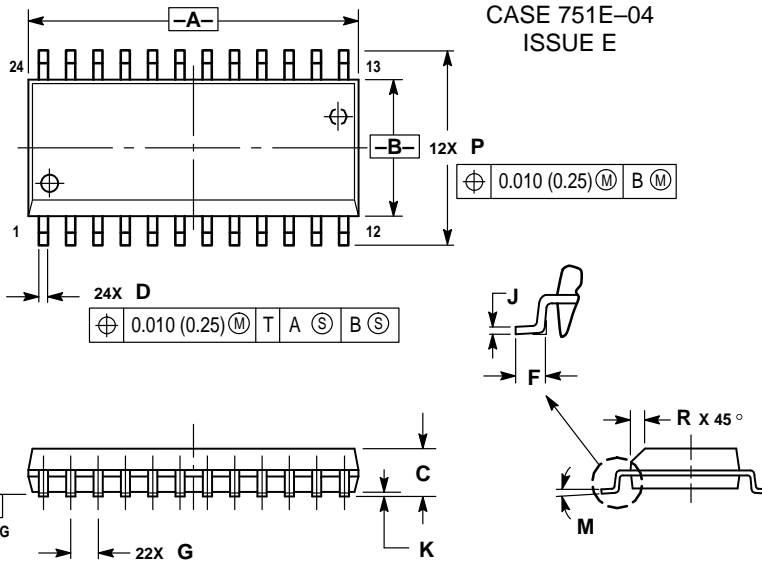

- NOTES:
1. DIMENSIONING AND TOLERANCING PER ANSI Y14.5M, 1982.
  2. CONTROLLING DIMENSION: MILLIMETER.
  3. DIMENSIONS A AND B DO NOT INCLUDE MOLD PROTRUSION.
  4. MAXIMUM MOLD PROTRUSION 0.15 (0.006) PER SIDE.
  5. DIMENSION D DOES NOT INCLUDE DAMBAR PROTRUSION. ALLOWABLE DAMBAR PROTRUSION SHALL BE 0.13 (0.005) TOTAL IN EXCESS OF D DIMENSION AT MAXIMUM MATERIAL CONDITION.

DIM	MILLIMETERS		INCHES	
	MIN	MAX	MIN	MAX
A	15.25	15.54	0.601	0.612
B	7.40	7.60	0.292	0.299
C	2.35	2.65	0.093	0.104
D	0.35	0.49	0.014	0.019
F	0.41	0.90	0.016	0.035
G	1.27 BSC		0.050 BSC	
J	0.23	0.32	0.009	0.013
K	0.13	0.29	0.005	0.011
M	0°	8°	0°	8°
P	10.05	10.55	0.395	0.415
R	0.25	0.75	0.010	0.029

Motorola reserves the right to make changes without further notice to any products herein. Motorola makes no warranty, representation or guarantee regarding the suitability of its products for any particular purpose, nor does Motorola assume any liability arising out of the application or use of any product or circuit, and specifically disclaims any and all liability, including without limitation consequential or incidental damages. "Typical" parameters can and do vary in different applications. All operating parameters, including "Typicals" must be validated for each customer application by customer's technical experts. Motorola does not convey any license under its patent rights nor the rights of others. Motorola products are not designed, intended, or authorized for use as components in systems intended for surgical implant into the body, or other applications intended to support or sustain life, or for any other application in which the failure of the Motorola product could create a situation where personal injury or death may occur. Should Buyer purchase or use Motorola products for any such unintended or unauthorized application, Buyer shall indemnify and hold Motorola and its officers, employees, subsidiaries, affiliates, and distributors harmless against all claims, costs, damages, and expenses, and reasonable attorney fees arising out of, directly or indirectly, any claim of personal injury or death associated with such unintended or unauthorized use, even if such claim alleges that Motorola was negligent regarding the design or manufacture of the part. Motorola and  are registered trademarks of Motorola, Inc. Motorola, Inc. is an Equal Opportunity/Affirmative Action Employer.

#### How to reach us:

USA/EUROPE: Motorola Literature Distribution;  
P.O. Box 20912; Phoenix, Arizona 85036. 1-800-441-2447

JAPAN: Nippon Motorola Ltd.; Tatsumi-SPD-JLDC, Toshikatsu Otsuka,  
6F Seibu-Butsuryu-Center, 3-14-2 Tatsumi Koto-Ku, Tokyo 135, Japan. 03-3521-8315

MFAX: RMFAX0@email.sps.mot.com -TOUCHTONE (602) 244-6609  
INTERNET: <http://Design-NET.com>

HONG KONG: Motorola Semiconductors H.K. Ltd.; 8B Tai Ping Industrial Park,  
51 Ting Kok Road, Tai Po, N.T., Hong Kong. 852-26629298



MC74AC648/D

