

Power Schottky Rectifier - 40Amp 100Volt

Features

- Plastic package has Underwriters Laboratory Flammability Classifications 94V-0
- High Junction Temperature Capability
- Low forward voltage, high current capability
- High surge capacity
- Low power loss, high efficiency
- ESD performance human body mode > 8 KV

Application

- AC/DC Switching Adaptor and TFT-LCD Power Supply
- SMPS

Absolute maximum ratings

Symbol	Ratings	Unit	Conditions
$I_F(AV)$	40	A	Average Forward Current
V_{RRM}	100	V	Repetitive Peak Reverse Voltage
I_{FSM}	400	A	Peak Forward Surge Current
$V_F(max)$	0.66	V	Forward Voltage Drop
T_j	-50 to +175	°C	Operating Temperature
T_{stg}	-50 to +150	°C	Storage Temperature

Electrical characteristics

Parameters	Symbol	Ratings	Conditions
Maximum Instantaneous Forward Voltage	V_F	0.82V	$T_c = 25^\circ C$
Forward Voltage		0.66V	$T_c = 125^\circ C$
Maximum Reverse Leakage Current	I_R	0.01mA	$T_c = 25^\circ C$
Current		10mA	$T_c = 125^\circ C$
Maximum Voltage Rate of Change	dv/dt	10,000 V/ μs	Rated VR
Typical Thermal Resistance, Junction to Case	$R_{\theta(j-c)}$	2.2 °C/W	Per diode

Note: Pulse Test : 380 μs pulse width, 2% duty cycle

T0-220AB

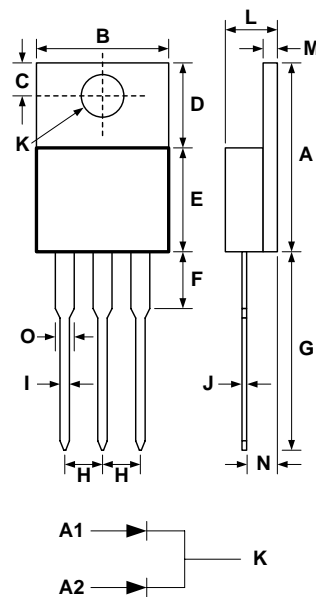

DIM	DIMENSIONS				NOTE
	INCHES		MM		
	MIN	MAX	MIN	MAX	
A	.579	.606	14.70	15.40	
B	.392	.411	9.95	10.45	
C	.104	.116	2.65	2.95	
D	.248	.272	6.30	6.90	
E	.325	.350	8.25	8.90	
F	.126	.157	3.20	4.00	
G	.492	.551	12.50	14.00	
H	.096	.108	2.45	2.75	
I	.028	.039	0.70	1.00	
J	.010	.022	0.25	0.55	
K	.146	.157	3.70	4.00	
L	.167	.187	4.25	4.75	
M	.045	.057	1.15	1.45	
N	.089	.114	2.25	2.90	
O	.047	.055	1.20	1.40	

August 2008 / Rev.6.1

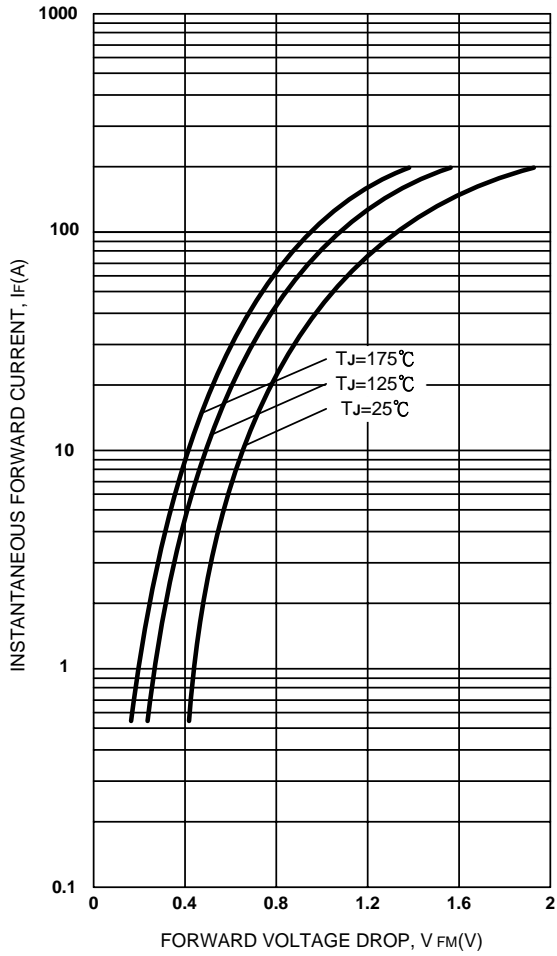

Figure 1. Max. Forward Voltage Drop Characteristics (PerLeg)

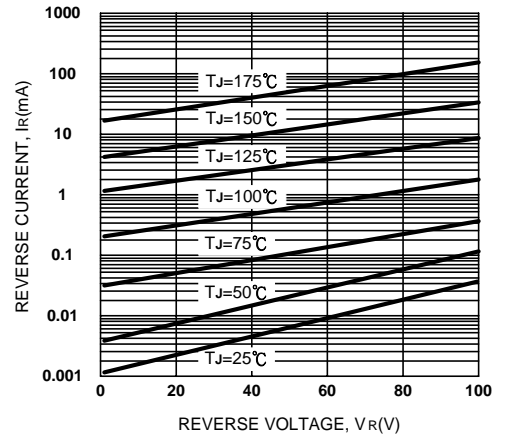

Figure 2. Typical Values Of Reverse Current Vs. Reverse Voltage (PerLeg)

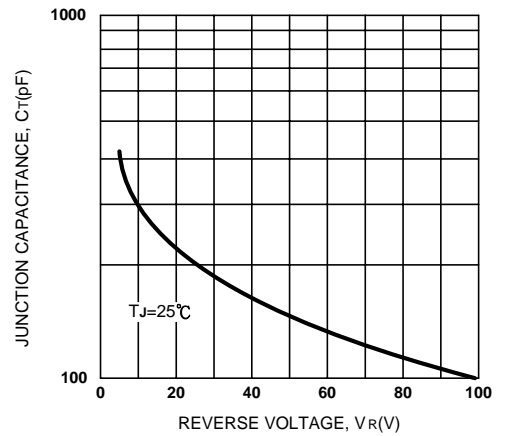

Figure 3. Typical Junction Capacitance Vs. Reverse Voltage (PerLeg)

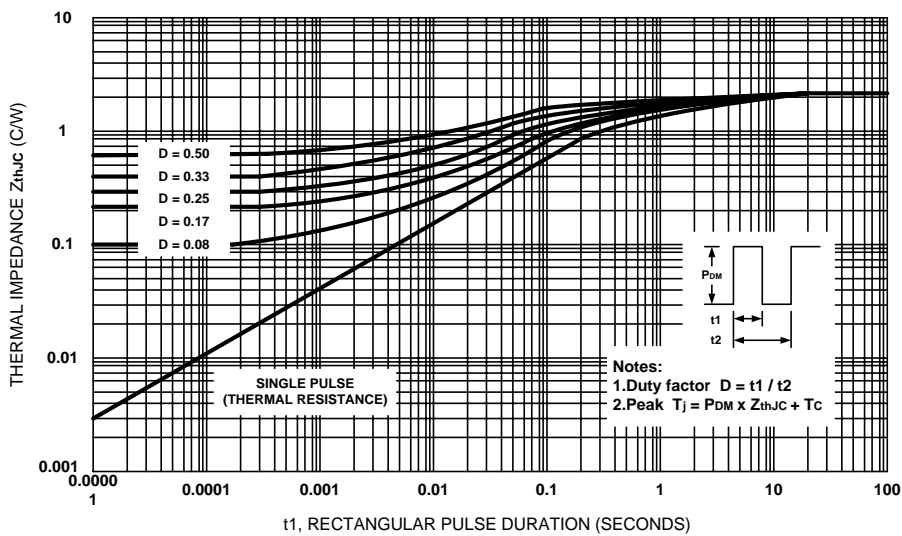

Figure 4. Max. Thermal Impedance Z_{thJC} Characteristics (PerLeg)

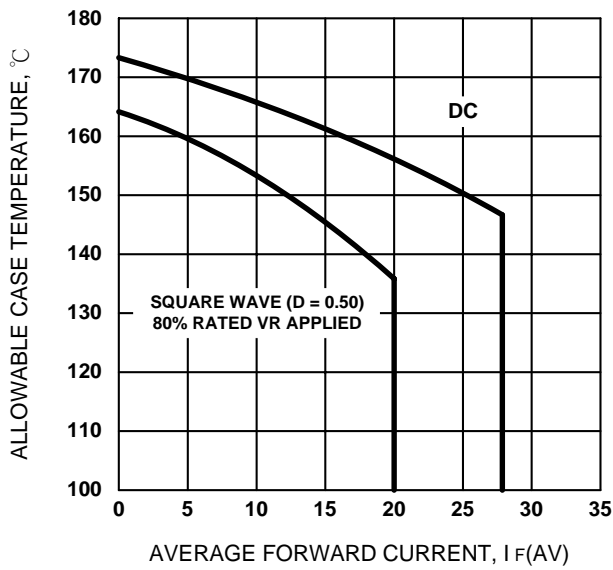

Figure 5. Max. Allowable Case Temperature Vs. Average Forward Current (Per Leg)

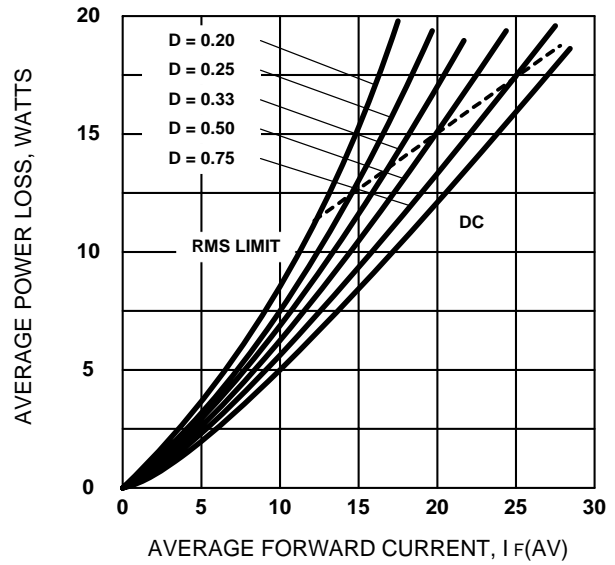

Figure 6. Forward Power Loss Characteristics (Per Leg)

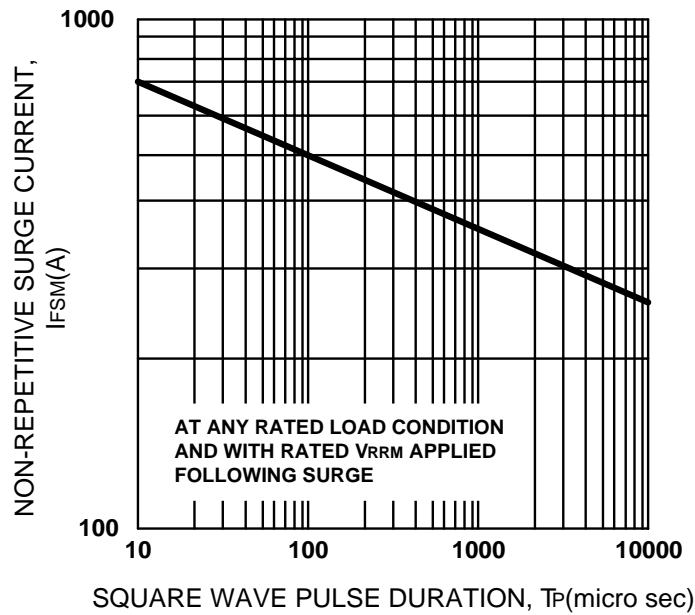

Figure 7. Max. Non-Repetitive Surge Current (Per Leg)