



Calibrated, Low-Drift, +4.096V/+5V/+10V Precision Voltage References

MAX676/MAX677/MAX678

General Description

The MAX676/MAX677/MAX678 precision +4.096V, +5V, and +10V voltage references feature a factory-programmed on-chip ROM that calibrates each reference at specific temperatures, and reduces the temperature drift to less than 1ppm/°C over temperature—the lowest in the industry.

The MAX676/MAX677/MAX678 have excellent line and load regulation: 30ppm/V and 3ppm/mA, respectively. Load regulation specifications are guaranteed for source currents up to 5mA and sink currents up to 500µA. The 4.096V MAX676 operates from a supply voltage as low as 4.75V, making it an ideal reference for single 5V, high resolution ADCs.

Applications

- High Resolution 16-Bit ADCs and DACs
- Precision Test and Measurement Systems
- Precision, Calibrated Voltage-Reference Standard
- High-Accuracy Transducers

Features

- ◆ **Lowest Temperature Drift:**
1ppm/°C Max Over -40°C to +85°C
1.5ppm/°C Max Over -55°C to +125°C
- ◆ **0.02% Initial Accuracy**
- ◆ **3ppm/mA Max Load Regulation**
- ◆ **30ppm/V Max Line Regulation**
- ◆ **4.096V Reference Operates from 5V ±5% Supply**
- ◆ **Available in Surface-Mount Package**

Ordering Information

PART	TEMP. RANGE	PIN-PACKAGE	MAX DRIFT (ppm/°C)
MAX676ACPP	0 °C to +70 °C	20 Plastic DIP	1.0
MAX676BCPP	0 °C to +70 °C	20 Plastic DIP	2.0
MAX676ACWP	0 °C to +70 °C	20 Wide SO	1.0
MAX676BCWP	0 °C to +70 °C	20 Wide SO	2.0
MAX676ACJP	0 °C to +70 °C	20 CERDIP	1.0
MAX676AEPP	-40 °C to +85 °C	20 Plastic DIP	1.0
MAX676BEPP	-40 °C to +85 °C	20 Plastic DIP	2.0
MAX676AEWP	-40 °C to +85 °C	20 Wide SO	1.0
MAX676BEWP	-40 °C to +85 °C	20 Wide SO	2.0
MAX676AEJP	-40 °C to +85 °C	20 CERDIP	1.0
MAX676AMJP	-55 °C to +125 °C	20 CERDIP	1.5
MAX676BMJP	-55 °C to +125 °C	20 CERDIP	3.0

Ordering Information continued on last page.

Typical Operating Circuit

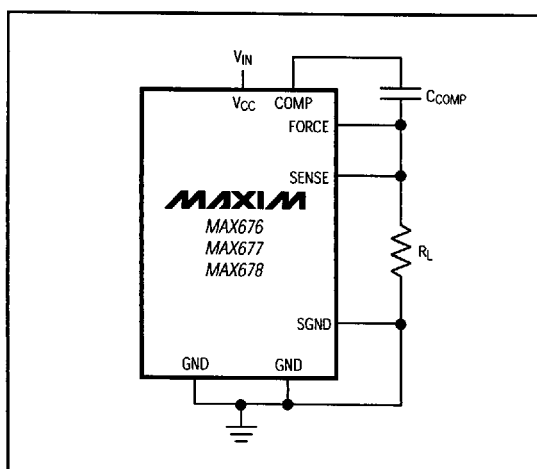

Pin Configuration

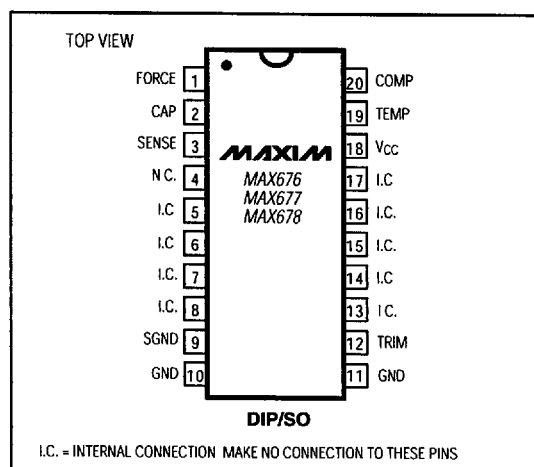

Maxim Integrated Products 1

Call toll free 1-800-998-8800 for free samples or literature.

MAX676/MAX677/MAX678

Calibrated, Low-Drift, +4.096V/+5V/+10V Precision Voltage References

ABSOLUTE MAXIMUM RATINGS

V_{CC} to GND.....-0.3V, +20V
 Output Short-Circuit Duration (to GND or V_{CC})Continuous
 Voltage at Any Pin(GND - 0.3V), (V_{CC} + 0.3V)
 Current into Any Pin.....±50mA
 Continuous Power Dissipation (T_A = +70 °C)
 Plastic DIP (derate 11.11mW/°C above +70 °C)889mW
 SO (derate 10.00mW/°C above +70 °C).....800mW
 CERDIP (derate 11.11mW/°C above +70 °C).....889mW

Operating Temperature Ranges:
 MAX67__C_P0 °C to +70 °C
 MAX67__E_P-40 °C to +85 °C
 MAX67__MJP-55 °C to +125 °C
 Storage Temperature Range.....-65 °C to +160 °C
 Lead Temperature (soldering, 10sec).....+300 °C

Stresses beyond those listed under "Absolute Maximum Ratings" may cause permanent damage to the device. These are stress ratings only, and functional operation of the device at these or any other conditions beyond those indicated in the operational sections of the specifications is not implied. Exposure to absolute maximum rating conditions for extended periods may affect device reliability.

ELECTRICAL CHARACTERISTICS—MAX676

(V_{CC} = +5V, I_L = 0mA, T_A = +25 °C, unless otherwise noted.)

PARAMETER	SYMBOL	CONDITIONS	MIN	TYP	MAX	UNITS	
Output Voltage	V _{OUT}	T _A = +25 °C	4.0952	4.0960	4.0968	V	
		T _A = T _{MIN} to T _{MAX}	MAX676AC	4.09491			4.09709
			MAX676BC	4.09463			4.09737
			MAX676AE	4.09469			4.09731
			MAX676BE	4.09418			4.09782
			MAX676AM	4.09409			4.09791
MAX676BM	4.09299		4.09901				
Output Voltage Drift (Note 1)	TCV _{OUT}	T _A = T _{MIN} to T _{MAX}	MAX676AC/AE	0.6	1.0	ppm/°C	
			MAX676BC/BE	1.2	2.0		
			MAX676AM	0.8	1.5		
			MAX676BM	1.5	3.0		
Long-Term Output Drift		MAX676A_JP (CERDIP only)		5	20	ppm/khrs	
		MAX676 (all other packages)		25			
Load Regulation		T _A = +25 °C	I _L = 0mA to 2mA	1	3	ppm/mA	
			I _L = 0mA to 5mA	5	10		
			I _L = 0mA to -0.5mA	5	20		
		T _A = T _{MIN} to T _{MAX}	MAX676_C	I _L = 0mA to 2mA			10
			MAX676_E	I _L = 0mA to -0.5mA			30
				I _L = 0mA to 2mA			10
MAX676_M	I _L = 0mA to -0.5mA		30				
I _L = 0mA to 2mA		15					
I _L = 0mA to -0.5mA		50					
Line Regulation		T _A = +25 °C, 4.75V ≤ V _{CC} ≤ 18V		8	30	ppm/V	
		T _A = T _{MIN} to T _{MAX} , 4.75V ≤ V _{CC} ≤ 18V	MAX676_C		35		
			MAX676_E		35		
			MAX676_M		35		
Quiescent Supply Current	I _Q	T _A = +25 °C		5	10	mA	
		T _A = T _{MIN} to T _{MAX}	MAX676_C		12		
			MAX676_E		12		
			MAX676_M		14		
Output Noise Voltage	e _n	0.1Hz to 10Hz		1.2		μVp-p	
		10Hz to 1kHz (CAP pin open)		4		μVRMS	
Short-Circuit Output Current	I _{SC}	Output shorted to GND		15		mA	
Turn-On Settling Time		To 0.01%		100		μs	
Output Voltage Adjust Range					±2	mV	
TEMP PIN							
Voltage Output				1.8		V	
Temperature Sensitivity				6.0		mV/°C	

Calibrated, Low-Drift, +4.096V/+5V/+10V Precision Voltage References

ELECTRICAL CHARACTERISTICS—MAX677

(V_{CC} = +15V, I_L = 0mA, T_A = +25 °C, unless otherwise noted.)

PARAMETER	SYMBOL	CONDITIONS	MIN	TYP	MAX	UNITS	
Output Voltage	V _{OUT}	T _A = +25 °C	4.9990	5.0000	5.0010	V	
		T _A = T _{MIN} to T _{MAX}	MAX677AC	4.99865			5.00135
			MAX677BC	4.99830			5.00170
			MAX677AE	4.99837			5.00163
			MAX677BE	4.99775			5.00225
			MAX677AM	4.99765			5.00235
MAX677BM	4.99630		5.00370				
Output Voltage Drift (Note 1)	TCV _{OUT}	T _A = T _{MIN} to T _{MAX}	MAX677AC/AE	0.6	1.0	ppm/ °C	
			MAX677BC/BE	1.2	2.0		
			MAX677AM	0.8	1.5		
			MAX677BM	1.5	3.0		
Long-Term Output Drift		MAX677A_JP (CERDIP only)		5	20	ppm/khr	
		MAX677 (all other packages)		25			
Load Regulation		T _A = +25 °C	I _L = 0mA to 2mA	1	3	ppm/mA	
			I _L = 0mA to 5mA	5.6	10		
			I _L = 0mA to -0.5mA	5	20		
		T _A = T _{MIN} to T _{MAX}	MAX677_C	I _L = 0mA to 2mA			10
				I _L = 0mA to -0.5mA			30
			MAX677_E	I _L = 0mA to 2mA			10
				I _L = 0mA to -0.5mA			30
			MAX677_M	I _L = 0mA to 2mA			15
	I _L = 0mA to -0.5mA		50				
Line Regulation		T _A = +25 °C, 8V ≤ V _{CC} ≤ 18V		8	30	ppm/V	
		T _A = T _{MIN} to T _{MAX}	MAX677_C		35		
			MAX677_E		35		
Quiescent Supply Current	I _Q	T _A = +25 °C		6.5	10	mA	
		T _A = T _{MIN} to T _{MAX}	MAX677_C		12		
			MAX677_E		12		
Output Noise Voltage	e _n	0.1Hz to 10Hz		1.5		μVp-p	
		10Hz to 1kHz (CAP pin open)		5		μVRMS	
Short-Circuit Output Current	I _{SC}	Output shorted to GND		15		mA	
Turn-On Settling Time		To 0.01%		100		μs	
Output Voltage Adjust Range					±2.5	mV	
TEMP PIN							
Voltage Output				1.8		V	
Temperature Sensitivity				6.0		mV/ °C	

MAX676/MAX677/MAX678

Calibrated, Low-Drift, +4.096V/+5V/+10V Precision Voltage References

MAX676/MAX677/MAX678

ELECTRICAL CHARACTERISTICS—MAX678

(V_{CC} = +15V, I_L = 0mA, T_A = +25 °C, unless otherwise noted.)

PARAMETER	SYMBOL	CONDITIONS		MIN	TYP	MAX	UNITS	
Output Voltage	V _{OUT}	T _A = +25 °C		9.9980	10.0000	10.0020	V	
		T _A = T _{MIN} to T _{MAX}	MAX678AC	9.9973	10.0027			
			MAX678BC	9.9966	10.0034			
			MAX678AE	9.9967	10.0033			
			MAX678BE	9.9955	10.0045			
			MAX678AM	9.9953	10.0047			
MAX678BM	9.9926	10.0074						
Output Voltage Drift (Note 1)	TCV _{OUT}	T _A = T _{MIN} to T _{MAX}					ppm/ °C	
		MAX678AC/AE	0.6	1.0				
		MAX678BC/BE	1.2	2.0				
		MAX678AM	0.8	1.5				
Long-Term Output Drift		MAX678A_JP (CERDIP only)		5	20		ppm/khrs	
		MAX678 (all other packages)		25				
Load Regulation		T _A = +25 °C					ppm/mA	
		T _A = T _{MIN} to T _{MAX}	MAX678_C	I _L = 0mA to 2mA	1	3		
				I _L = 0mA to 5mA	5.6	10		
			MAX678_E	I _L = 0mA to 2mA	10			
				I _L = 0mA to -0.5mA	30			
			MAX678_M	I _L = 0mA to 2mA	10			
				I _L = 0mA to -0.5mA	30			
		T _A = +25 °C, 13V ≤ V _{CC} ≤ 18V			8	35		
T _A = T _{MIN} to T _{MAX}	MAX678_C	40						
	MAX678_E	40						
Quiescent Supply Current	I _Q	T _A = +25 °C			6.5	10	mA	
		T _A = T _{MIN} to T _{MAX}	MAX678_C	12				
			MAX678_E	12				
			MAX678_M	14				
Output Noise Voltage	e _n	0.1Hz to 10Hz			3		μVp-p	
		10Hz to 1kHz (CAP pin open)			10		μVRMS	
Short-Circuit Output Current	I _{SC}	Output shorted to GND			15		mA	
Turn-On Settling Time		To 0.01%			100		μs	
Output Voltage Adjust Range						±5	mV	
TEMP PIN								
Voltage Output					1.8		V	
Temperature Sensitivity					6.0		mV/ °C	

Note 1: Temperature coefficient is determined by the "box" method using the following formula:

$$\frac{V_{MAX} - V_{MIN}}{V_{NOMINAL} \times (T_{MAX} - T_{MIN})}$$

Calibrated, Low-Drift, +4.096V/+5V/+10V Precision Voltage References

Typical Operating Characteristics

($V_{CC} = +5V$ (MAX676), $V_{CC} = +15V$ (MAX677/MAX678), $I_L = 0mA$, $C_L < 100pF$, $T_A = +25^\circ C$, unless otherwise noted.)

MAX676/MAX677/MAX678

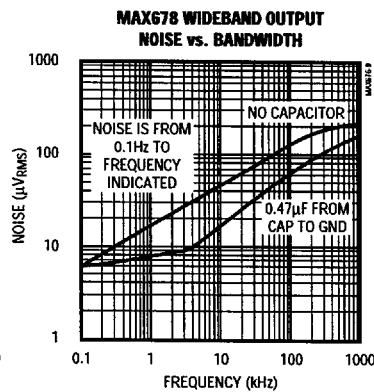
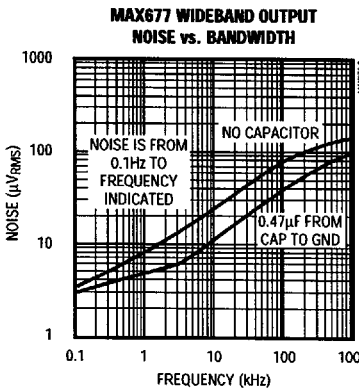
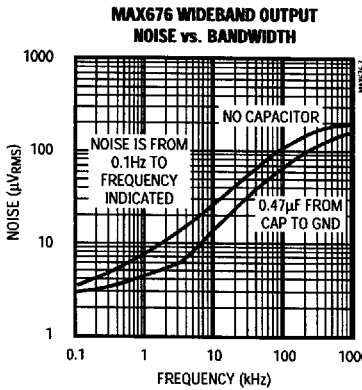
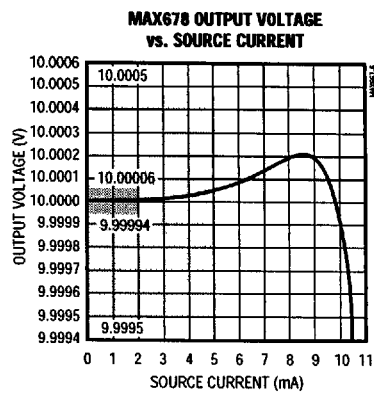
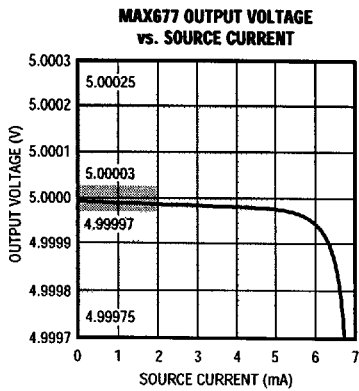
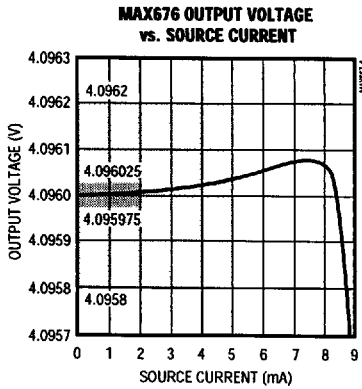
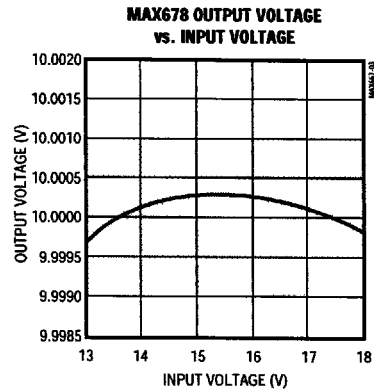
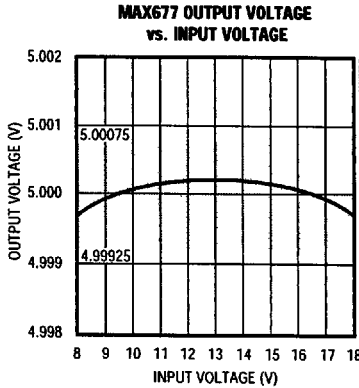
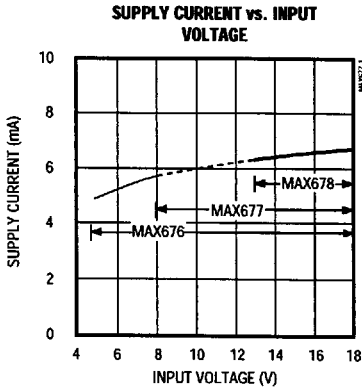

MAXIM

Calibrated, Low-Drift, +4.096V/+5V/+10V Precision Voltage References

Typical Operating Characteristics (continued)

(V_{CC} = +5V (MAX676), V_{CC} = +15V (MAX677/MAX678), I_L = 0mA, C_L < 100pF, T_A = +25 °C, unless otherwise noted.)

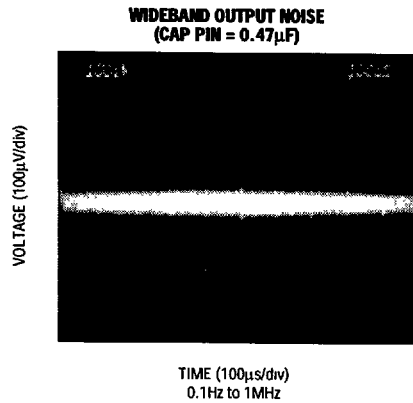
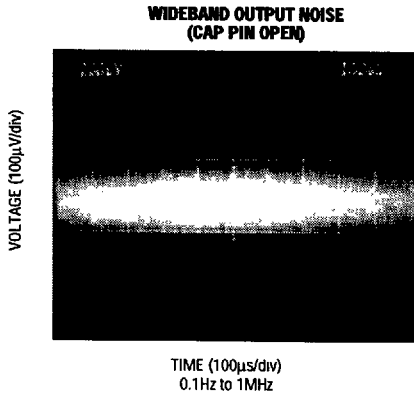
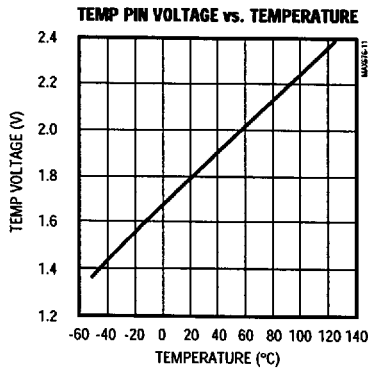
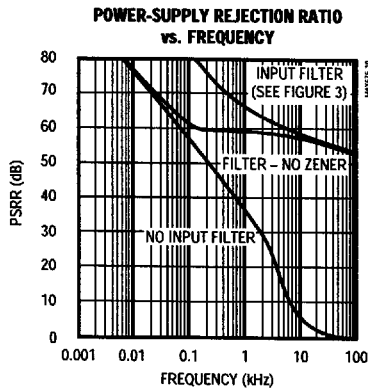

Calibrated, Low-Drift, +4.096V/+5V/+10V Precision Voltage References

Pin Description

MAX676/MAX677/MAX678

PIN	NAME	FUNCTION
1	FORCE	Output voltage force connection. This pin drives the load.
2	CAP	Optional capacitor connection for wideband noise reduction. Leave open if unused.
3	SENSE	Output voltage sense is connected at the load and maintains the voltage to the load at the reference voltage.
4	N.C.	No Connect. Not internally connected.
5, 6, 7, 8, 13, 14, 15, 16, 17	I.C.	Internal Connection. Make no connection to these pins.
9	SGND	Ground sense for the bandgap reference. The reference voltage is calibrated between SENSE and SGND.
10, 11	GND	Main ground pins. Connect both pins to ground.
12	TRIM	Used for trimming the reference voltage to a value slightly higher or lower than the nominal value. The output can be adjusted $\pm 0.05\%$ without affecting the drift specification. Leave open if unused.
18	VCC	Supply-voltage connection
19	TEMP	Temperature voltage output. This pin provides a voltage proportional to ambient temperature. The nominal value is 1.8V at +25 °C, with a typical temperature coefficient of 6mV/ °C. Leave open if unused.
20	COMP	A compensation capacitor is required at this pin to compensate the output amplifier of the reference. The recommended value is 4.7nF.

Detailed Description

The MAX676/MAX677/MAX678 include a 1.2V bandgap reference and an amplifier, and provide outputs of 4.096V, 5V, and 10V. Ideally, the bandgap reference does not vary with temperature. In practice, however, some temperature coefficient exists. The MAX676/MAX677/MAX678 significantly reduce this remaining variation using an "analog ROM" that adds or subtracts a small voltage from the reference, depending on the device's temperature. During production, each device is tested and calibrated at 16 temperatures to minimize the output error over the entire operating temperature range.

A conventional voltage reference may have a linear, bow-shaped, or S-shaped temperature characteristic. Due to the internal ROM's action, the MAX676/MAX677/MAX678 can have a distinctly different temperature characteristic from that of other references. The calibration algorithm, which minimizes the output error over temperature, gives each device a unique voltage profile over temperature, always staying close to the desired output voltage. A graph of output voltage vs. temperature for a MAX677, along with the pre-calibration performance, is given in Figure 1. The pre-calibration performance is seen at the factory, and cannot be observed on finished units.

Calibrated, Low-Drift, +4.096V/+5V/+10V Precision Voltage References

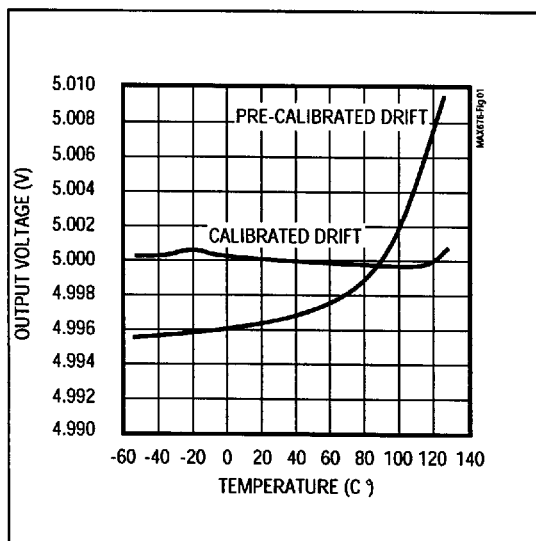

Figure 1. MAX677 Temperature Drift

Applications Information

Input Bypassing

For best transient performance, decouple the input using a 4.7 μ F to 10 μ F tantalum or electrolytic capacitor in parallel with a 0.01 μ F to 0.1 μ F ceramic capacitor as shown in Figure 2. Where transient performance is less important, a single 0.1 μ F ceramic suffices.

Input Filter for High-Frequency Noise

Typically, the MAX676/MAX677/MAX678 references will be used with other sensitive analog components and will have a high-quality, low-noise power supply. However, it may be necessary or desirable to use these references with a noisy switching power supply or a supply contaminated with switching noise from digital components. In this situation, Figure 3's circuit provides excellent noise rejection, at the expense of some input voltage headroom and supply current.

If the load does not vary, the zener, which prevents load variations from causing additional impact as line variations, may be omitted. The Power-Supply Rejection Ratio vs. Frequency graph in the *Typical Operating Characteristics* shows how the zener provides better low-frequency rejection than the same filter

without the zener. The zener voltage (V_Z) should be less than the minimum level of the input voltage without the zener present. This voltage is given by:

$$V_Z \leq V_{IN(\min)} - (I_Q + I_{LOAD})(R_S)$$

Output Bypassing

These devices function well without output bypassing, but the output should be bypassed if there are rapid changes in load current, such as those caused by sampling ADCs. A 0.1 μ F ceramic capacitor may be used alone or in parallel with up to a 10 μ F tantalum or electrolytic capacitor for improved load-transient performance.

Output-Voltage Trimming

With the addition of a potentiometer as shown in Figure 4, the TRIM input can be used to adjust the output voltage. The trim range is ± 2 mV for the MAX676, ± 2.5 mV for the MAX677, and ± 5 mV for the MAX678. The reference temperature coefficient is unaffected by trimming within these ranges.

Compensation

The MAX676/MAX677/MAX678's output amplifier requires a compensation capacitor for stable operation. 4.7nF is recommended, although any value from 2.2nF through 100nF may be used. Values smaller than 2.2nF can result in instability at very cold temperatures, while large values may decrease high-frequency power-supply noise rejection.

CAP Pin Noise Filter

The CAP input connects to an internal node located between the bandgap reference and the output amplifier (Figure 5). Connecting a capacitor to this pin effectively forms a low-pass filter with the internal 1.5k Ω resistor, reducing noise from the bandgap reference (see the Wideband Output Noise vs. Bandwidth graph in the *Typical Operating Characteristics*.) A low-leakage capacitor must be used. Leave unconnected if unused.

Temperature Measurement with TEMP Output

The TEMP output provides a voltage proportional to ambient temperature. This information may be used to control LCD contrast, or to provide ADC gain compensation or thermal out-of-range indication. TEMP must be buffered or connected to a high-impedance input. Leave unconnected if unused.

Calibrated, Low-Drift, +4.096V/+5V/+10V Precision Voltage References

MAX676/MAX677/MAX678

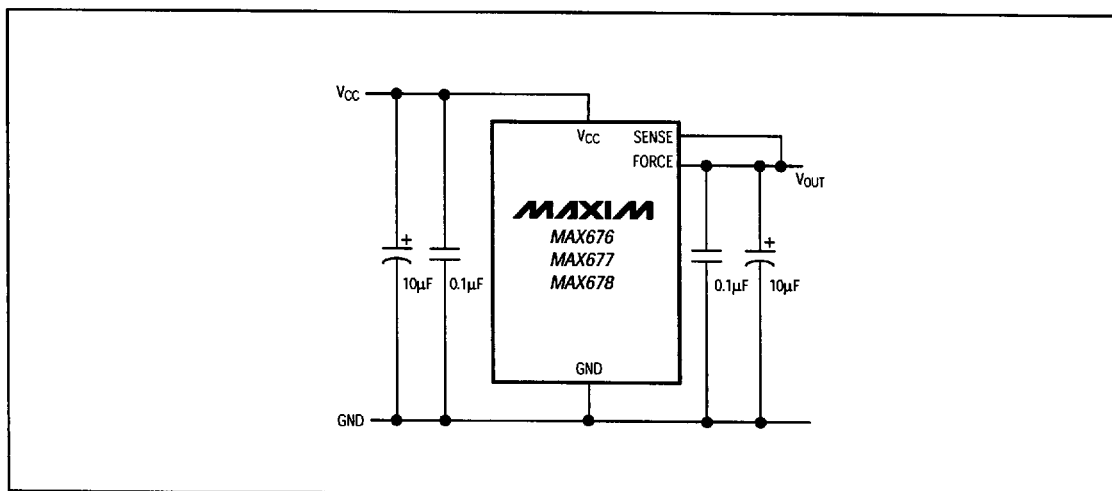

Figure 2. Recommended Input and Output Bypassing (other pin connections omitted for clarity)

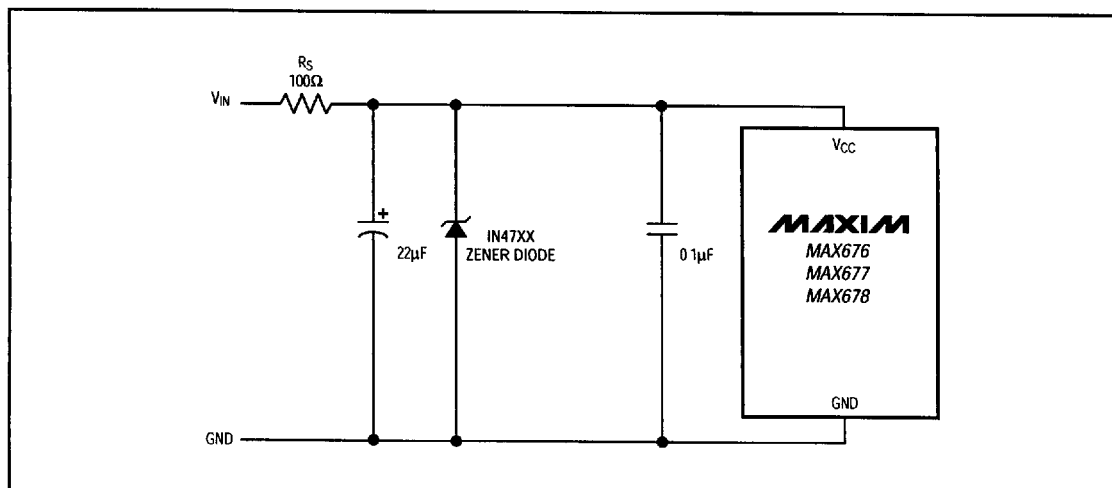

Figure 3. Input Filter for Improved High-Frequency Supply Rejection

Calibrated, Low-Drift, +4.096V/+5V/+10V Precision Voltage References

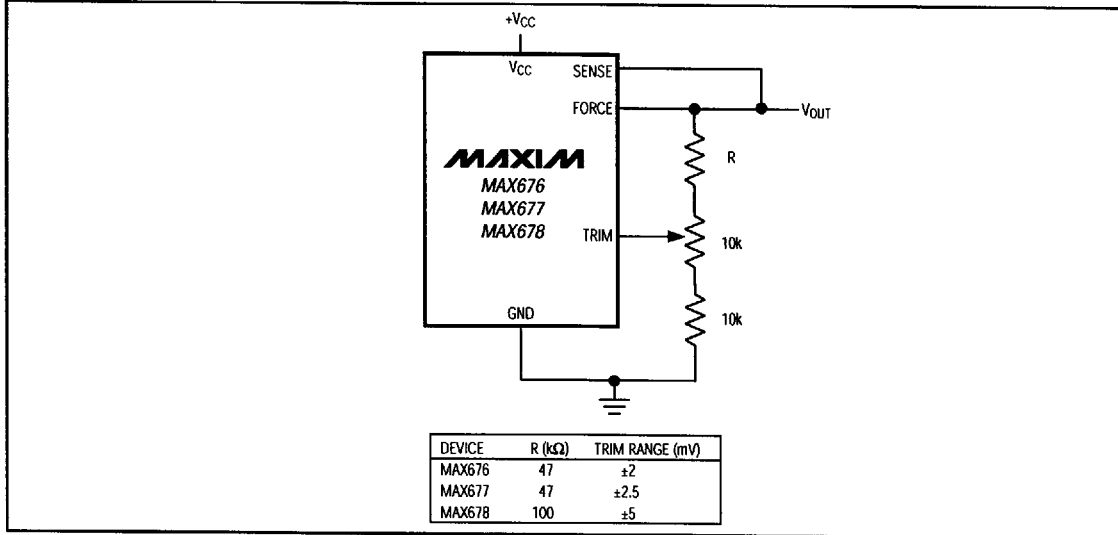

Figure 4. Adjusting V_{OUT} with the TRIM input (other pin connections omitted for clarity)

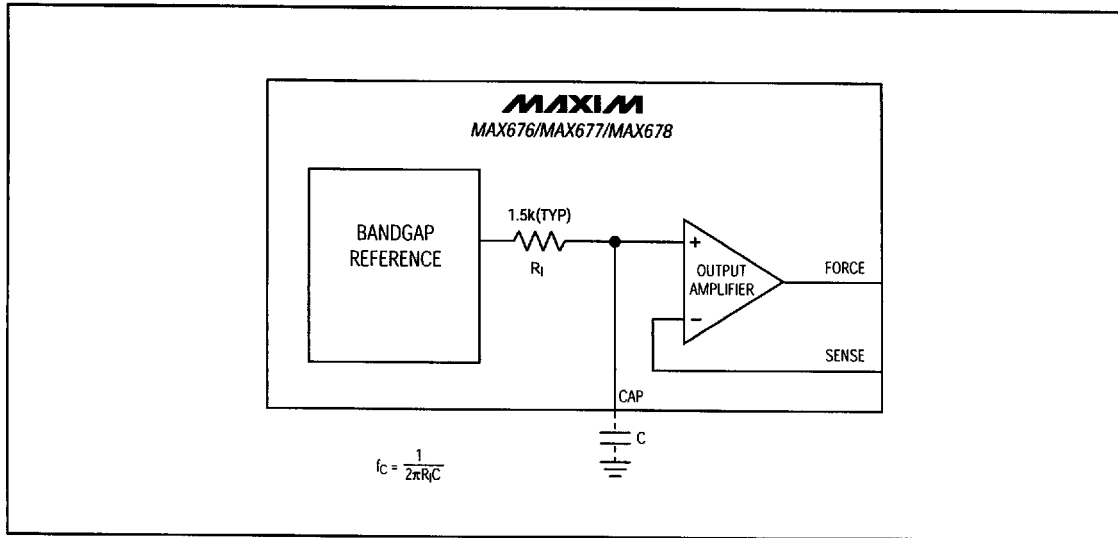

Figure 5. External Capacitor for Reference Noise Reduction

Calibrated, Low-Drift, +4.096V/+5V/+10V Precision Voltage References

Ordering Information (continued)

PART	TEMP. RANGE	PIN-PACKAGE	MAX DRIFT (ppm/°C)
MAX677ACPP	0 °C to +70 °C	20 Plastic DIP	1.0
MAX677BCPP	0 °C to +70 °C	20 Plastic DIP	2.0
MAX677ACWP	0 °C to +70 °C	20 Wide SO	1.0
MAX677BCWP	0 °C to +70 °C	20 Wide SO	2.0
MAX677ACJP	0 °C to +70 °C	20 CERDIP	1.0
MAX677AEPP	-40 °C to +85 °C	20 Plastic DIP	1.0
MAX677BEPP	-40 °C to +85 °C	20 Plastic DIP	2.0
MAX677AEWP	-40 °C to +85 °C	20 Wide SO	1.0
MAX677BEWP	-40 °C to +85 °C	20 Wide SO	2.0
MAX677AEJP	-40 °C to +85 °C	20 CERDIP	1.0
MAX677AMJP	-55 °C to +125 °C	20 CERDIP	1.5
MAX677BMJP	-55 °C to +125 °C	20 CERDIP	3.0
MAX678ACPP	0 °C to +70 °C	20 Plastic DIP	1.0
MAX678BCPP	0 °C to +70 °C	20 Plastic DIP	2.0
MAX678ACWP	0 °C to +70 °C	20 Wide SO	1.0
MAX678BCWP	0 °C to +70 °C	20 Wide SO	2.0
MAX678ACJP	0 °C to +70 °C	20 CERDIP	1.0
MAX678AEPP	-40 °C to +85 °C	20 Plastic DIP	1.0
MAX678BEPP	-40 °C to +85 °C	20 Plastic DIP	2.0
MAX678AEWP	-40 °C to +85 °C	20 Wide SO	1.0
MAX678BEWP	-40 °C to +85 °C	20 Wide SO	2.0
MAX678AEJP	-40 °C to +85 °C	20 CERDIP	1.0
MAX678AMJP	-55 °C to +125 °C	20 CERDIP	1.5
MAX678BMJP	-55 °C to +125 °C	20 CERDIP	3.0

TRANSISTOR COUNT: 1465

MAX676/MAX677/MAX678

Calibrated, Low-Drift, +4.096V/+5V/+10V Precision Voltage References

MAX676/MAX677/MAX678

Package Information

**Plastic DIP
PLASTIC
DUAL-IN-LINE
PACKAGE
(0.300 in.)**

DIM	INCHES		MILLIMETERS	
	MIN	MAX	MIN	MAX
A	—	0.200	—	5.08
A1	0.015	—	0.38	—
A2	0.125	0.175	3.18	4.45
A3	0.055	0.080	1.40	2.03
B	0.016	0.022	0.41	0.56
B1	0.045	0.065	1.14	1.65
C	0.008	0.012	0.20	0.30
D1	0.005	0.080	0.13	2.03
E	0.300	0.325	7.62	8.26
E1	0.240	0.310	6.10	7.87
e	0.100	—	2.54	—
eA	0.300	—	7.62	—
eB	—	0.400	—	10.16
L	0.115	0.150	2.92	3.81

DIM	PINS	INCHES		MILLIMETERS	
		MIN	MAX	MIN	MAX
D	8	0.348	0.390	8.84	9.91
D	14	0.735	0.765	18.67	19.43
D	16	0.745	0.765	18.92	19.43
D	18	0.885	0.915	22.48	23.24
D	20	1.015	1.045	25.78	26.54
D	24	1.14	1.265	28.96	32.13

**Wide SO
SMALL OUTLINE
PACKAGE
(0.300 in.)**

DIM	INCHES		MILLIMETERS	
	MIN	MAX	MIN	MAX
A	0.093	0.104	2.35	2.65
A1	0.004	0.012	0.10	0.30
B	0.014	0.019	0.35	0.49
C	0.009	0.013	0.23	0.32
E	0.291	0.299	7.40	7.60
e	0.050		1.27	
H	0.394	0.419	10.00	10.65
L	0.016	0.050	0.40	1.27

DIM	PINS	INCHES		MILLIMETERS	
		MIN	MAX	MIN	MAX
D	16	0.398	0.413	10.10	10.50
D	18	0.447	0.463	11.35	11.75
D	20	0.496	0.512	12.60	13.00
D	24	0.598	0.614	15.20	15.60
D	28	0.697	0.713	17.70	18.10

21-0042A

Maxim cannot assume responsibility for use of any circuitry other than circuitry entirely embodied in a Maxim product. No circuit patent licenses are implied. Maxim reserves the right to change the circuitry and specifications without notice at any time.

12 Maxim Integrated Products, 120 San Gabriel Drive, Sunnyvale, CA 94086 (408) 737-7600

© 1993 Maxim Integrated Products

Printed USA

MAXIM is a registered trademark of Maxim Integrated Products.