



Low-Noise, Low-Dropout, 200mA Linear Regulator

MAX1598

General Description

The MAX1598 low-noise, low-dropout linear regulator operates from a 2.5V to 6.5V input and delivers up to 200mA. Typical output noise is 30 μ V_{RMS}, and typical dropout is only 236mV at 200mA. The output voltage is preset to voltages from 2.5V to 5V in 100mV increments.

Designed with an internal P-channel MOSFET pass transistor, the MAX1598 maintains a low 100 μ A supply current independent of the load current and dropout voltage. Other features include a 10nA logic-controlled shutdown mode, short-circuit and thermal-shutdown protection, and reverse battery protection. The device also includes an autodischarge function, which actively discharges the output voltage to ground when the device is placed in shutdown. The MAX1598 comes in a thin 5-pin SOT23 package.

Features

- ◆ 200mA Output Current
- ◆ Low Output Noise: 30 μ V_{RMS}
- ◆ Low 55mV Dropout at 50mA Output
- ◆ Low 85 μ A No-Load Supply Current
- ◆ Low 100 μ A Operating Supply Current, Even in Dropout
- ◆ Thermal-Overload and Short-Circuit Protection
- ◆ Reverse Battery Protection
- ◆ Output Current Limit
- ◆ Preset Output Voltages
- ◆ 10nA Logic-Controlled Shutdown

Applications

- Cellular, Cordless, and PCS Phones
- PCMCIA Cards
- Modems
- Hand-Held Instruments
- Palmtop Computers
- Electronic Planners

Ordering Information

PART	TEMP RANGE	PIN-PACKAGE
MAX1598EZKxy-T*	-40°C to +85°C	Thin SOT23-5

*xy is the output voltage code (see the Selector Guide at end of data sheet).

Typical Operating Circuit

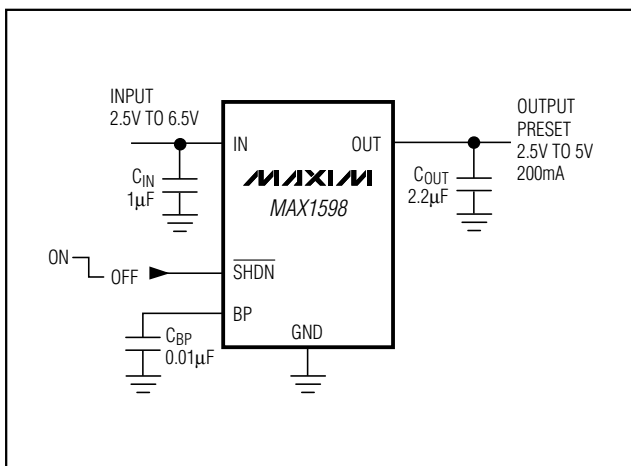

Pin Configuration

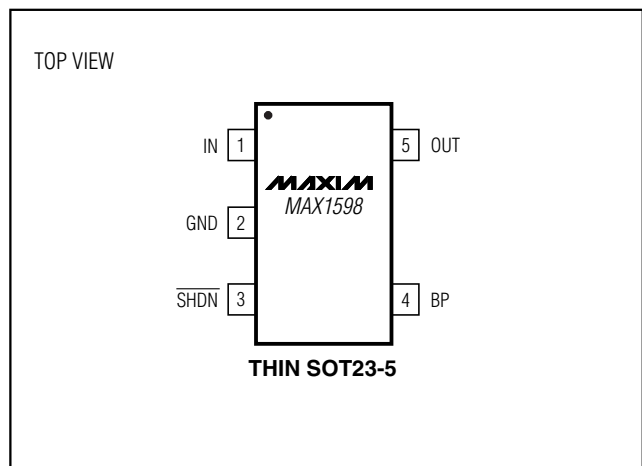

Low-Noise, Low-Dropout, 200mA Linear Regulator

ABSOLUTE MAXIMUM RATINGS

IN to GND	-7V to +7V	Operating Temperature Range	-40°C to +85°C
Output Short-Circuit Duration	Infinite	Junction Temperature	+150°C
$\overline{\text{SHDN}}$ to GND	-7V to +7V	θ_{JB} (thin)	110°C/W
$\overline{\text{SHDN}}$ to IN	-7V to +0.3V	Storage Temperature	-65°C to +150°C
OUT, BP to GND	-0.3V to ($V_{\text{IN}} + 0.3\text{V}$)	Lead Temperature (soldering, 10s)	+300°C
Continuous Power Dissipation ($T_{\text{A}} = +70^{\circ}\text{C}$)			
5-Pin Thin SOT23 (derate 9.1mW/°C above +70°C)	727mW		

Stresses beyond those listed under "Absolute Maximum Ratings" may cause permanent damage to the device. These are stress ratings only, and functional operation of the device at these or any other conditions beyond those indicated in the operational sections of the specifications is not implied. Exposure to absolute maximum rating conditions for extended periods may affect device reliability.

ELECTRICAL CHARACTERISTICS

($V_{\text{IN}} = (V_{\text{OUT(NOMINAL)}} + 0.5\text{V})$ or 2.5V (whichever is greater), $T_{\text{A}} = -40^{\circ}\text{C}$ to $+85^{\circ}\text{C}$, unless otherwise noted. Typical values are at $T_{\text{A}} = +25^{\circ}\text{C}$.) (Note 1)

PARAMETER	SYMBOL	CONDITIONS	MIN	TYP	MAX	UNITS	
Input Voltage	V_{IN}		2.5		6.5	V	
Output Voltage Accuracy		$I_{\text{OUT}} = 0.1\text{mA}$, $T_{\text{A}} = +25^{\circ}\text{C}$, $V_{\text{OUT}} \geq 2.5\text{V}$	-1.4		+1.4	%	
		$I_{\text{OUT}} = 0.1\text{mA}$ to 120mA, $T_{\text{A}} = -40^{\circ}\text{C}$ to $+85^{\circ}\text{C}$, $V_{\text{OUT}} \geq 2.5\text{V}$	-3		+2		
Maximum Output Current			200			mA	
Current Limit	I_{LIM}		220	458		mA	
Ground-Pin Current	I_{Q}	No load		85	180	μA	
		$I_{\text{OUT}} = 150\text{mA}$		100			
Dropout Voltage (Note 2)		$I_{\text{OUT}} = 1\text{mA}$		1.1		mV	
		$I_{\text{OUT}} = 50\text{mA}$		55	120		
		$I_{\text{OUT}} = 200\text{mA}$		236			
Line Regulation	ΔV_{LNR}	$V_{\text{IN}} = 2.5\text{V}$ or ($V_{\text{OUT}} + 0.1\text{V}$) to 6.5V, $I_{\text{OUT}} = 1\text{mA}$	-0.15	0	+0.15	%/V	
Load Regulation	ΔV_{LDR}	$I_{\text{OUT}} = 0.1\text{mA}$ to 120mA, $C_{\text{OUT}} = 1\mu\text{F}$		0.01	0.04	%/mA	
Output Voltage Noise	e_{n}	$f = 10\text{Hz}$ to 100kHz, $C_{\text{BP}} = 0.01\mu\text{F}$	$C_{\text{OUT}} = 10\mu\text{F}$		30	μVRMS	
			$C_{\text{OUT}} = 100\mu\text{F}$		20		
SHUTDOWN							
$\overline{\text{SHDN}}$ Input Threshold	V_{IH}	$V_{\text{IN}} = 2.5\text{V}$ to 5.5V		2.0		V	
	V_{IL}	$V_{\text{IN}} = 2.5\text{V}$ to 5.5V			0.4		
$\overline{\text{SHDN}}$ Input Bias Current	I_{SHDN}	$V_{\text{SHDN}} = V_{\text{IN}}$	$T_{\text{A}} = +25^{\circ}\text{C}$		0.01	1	μA
			$T_{\text{A}} = +85^{\circ}\text{C}$		0.5		
Shutdown Supply Current	$I_{\text{Q(SHDN)}}$	$V_{\text{OUT}} = 0\text{V}$	$T_{\text{A}} = +25^{\circ}\text{C}$		0.01	1	μA
			$T_{\text{A}} = +85^{\circ}\text{C}$		0.2		
Shutdown Exit Delay		$C_{\text{BP}} = 0.1\mu\text{F}$, $C_{\text{OUT}} = 1\mu\text{F}$, no load (Note 3)	$T_{\text{A}} = +25^{\circ}\text{C}$		30	150	μs
			$T_{\text{A}} = -40^{\circ}\text{C}$ to $+85^{\circ}\text{C}$			300	
Resistance Shutdown Discharge				300		Ω	

Low-Noise, Low-Dropout, 200mA Linear Regulator

ELECTRICAL CHARACTERISTICS (continued)

($V_{IN} = (V_{OUT(NOMINAL)} + 0.5V)$ or 2.5V (whichever is greater), $T_A = -40^{\circ}C$ to $+85^{\circ}C$, unless otherwise noted. Typical values are at $T_A = +25^{\circ}C$.) (Note 1)

PARAMETER	SYMBOL	CONDITIONS	MIN	TYP	MAX	UNITS
THERMAL PROTECTION						
Thermal-Shutdown Temperature	T_{SHDN}			155		$^{\circ}C$
Thermal-Shutdown Hysteresis	ΔT_{SHDN}			15		$^{\circ}C$

Note 1: Limits are 100% production tested at $T_A = +25^{\circ}C$. Limits over the operating temperature range are guaranteed through correlation using guaranteed by design (GBD) methods.

Note 2: The dropout voltage is defined as $V_{IN} - V_{OUT}$, when V_{OUT} is 100mV below the value of V_{OUT} for $V_{IN} = V_{OUT} + 0.5V$.

Note 3: Time needed for V_{OUT} to reach 95% of final value.

Typical Operating Characteristics

($V_{IN} = (V_{OUT(NOMINAL)} + 0.5V)$ or 2.5V (whichever is greater), $C_{IN} = 1\mu F$, $C_{OUT} = 2.2\mu F$, $C_{BP} = 0.01\mu F$, $T_A = +25^{\circ}C$, unless otherwise noted.)

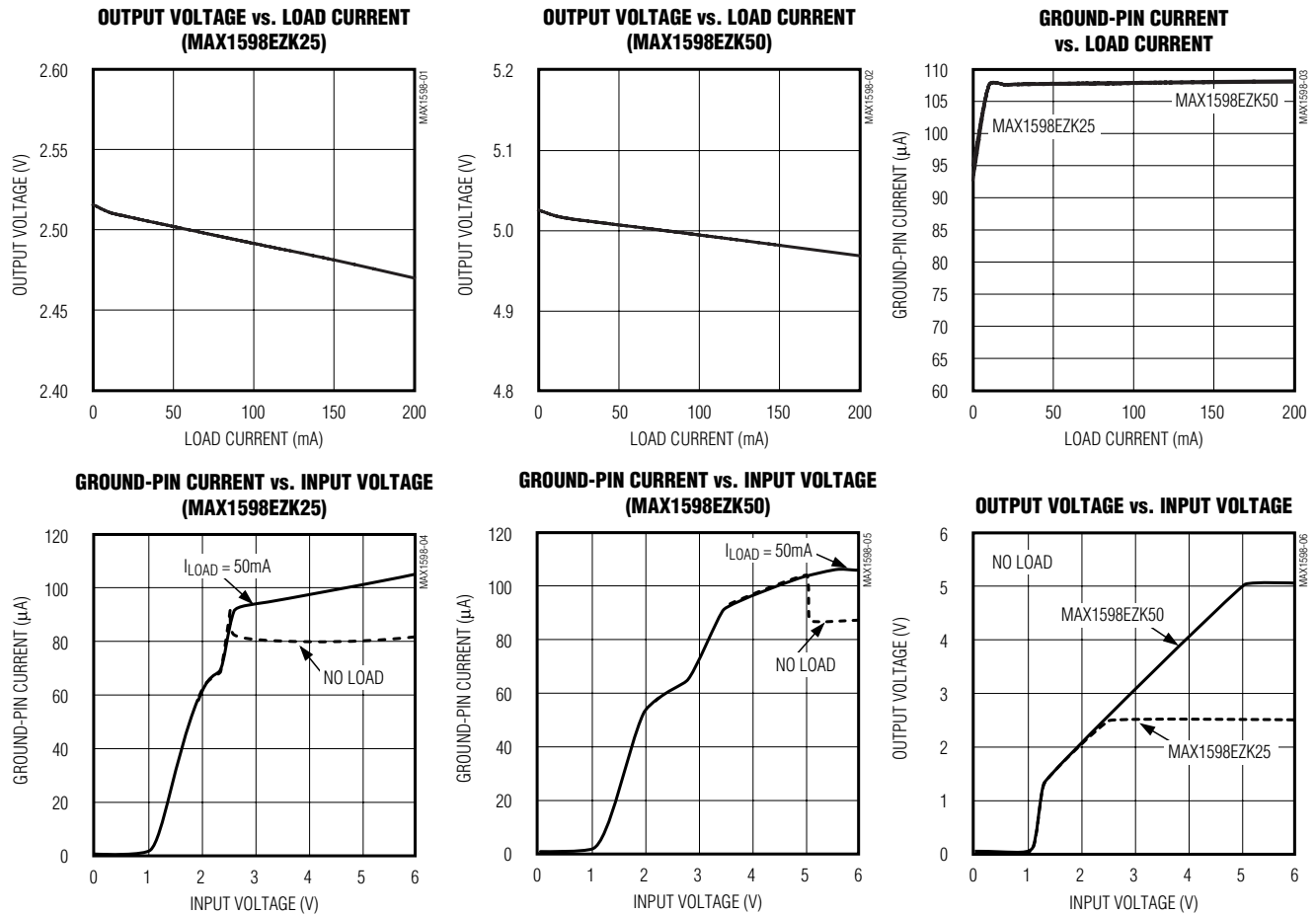

Low-Noise, Low-Dropout, 200mA Linear Regulator

Typical Operating Characteristics (continued)

($V_{IN} = (V_{OUT(NOMINAL)} + 0.5V)$ or $2.5V$ (whichever is greater), $C_{IN} = 1\mu F$, $C_{OUT} = 2.2\mu F$, $C_{BP} = 0.01\mu F$, $T_A = +25^\circ C$, unless otherwise noted.)

OUTPUT VOLTAGE vs. TEMPERATURE (MAX1598EZK25)

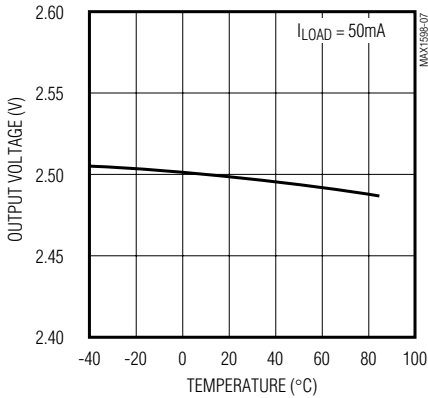

OUTPUT VOLTAGE vs. TEMPERATURE (MAX1598EZK50)

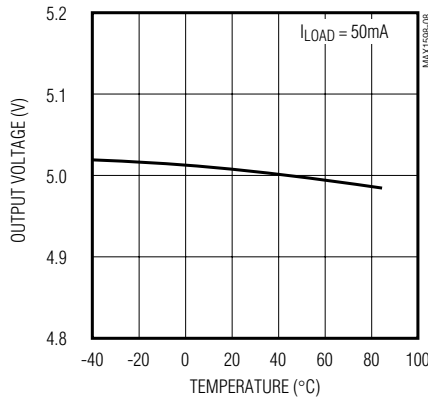

GROUND-PIN CURRENT vs. TEMPERATURE

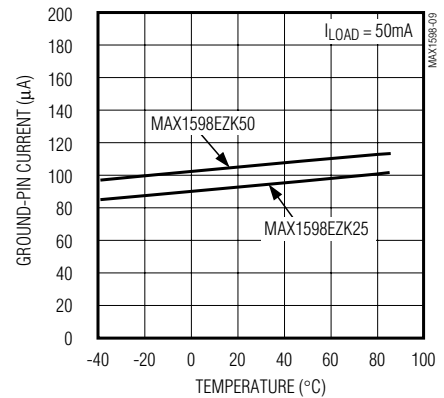

DROPOUT VOLTAGE vs. LOAD CURRENT (MAX1598EZK25)

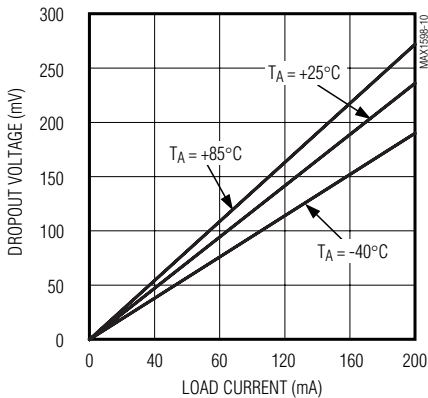

DROPOUT VOLTAGE vs. LOAD CURRENT (MAX1598EZK50)

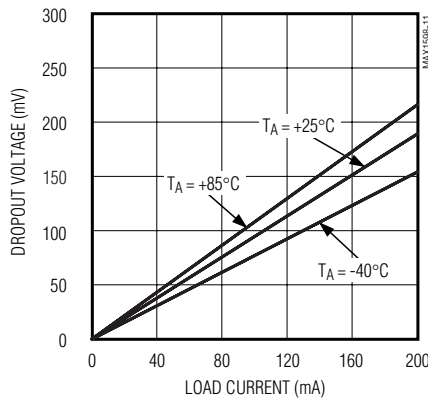

POWER-SUPPLY REJECTION RATIO vs. FREQUENCY

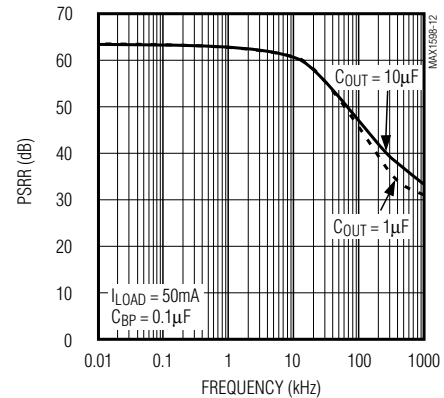

OUTPUT NOISE SPECTRAL DENSITY vs. FREQUENCY

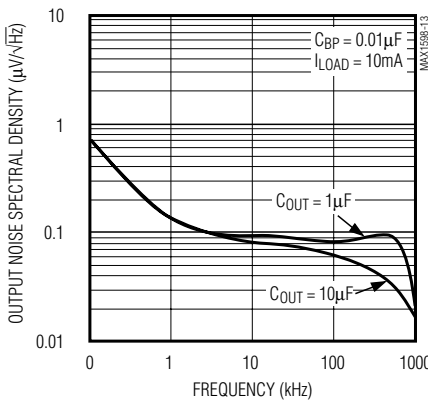

OUTPUT NOISE vs. BP CAPACITANCE

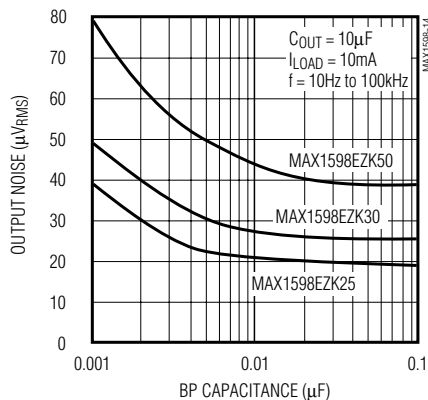

OUTPUT NOISE vs. LOAD CURRENT

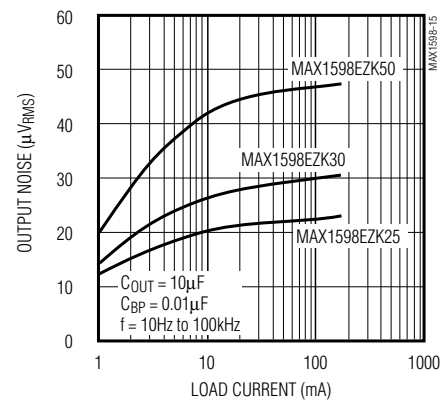

Low-Noise, Low-Dropout, 200mA Linear Regulator

MAX1598

Typical Operating Characteristics (continued)

($V_{IN} = (V_{OUT(NOMINAL)} + 0.5V)$ or 2.5V (whichever is greater), $C_{IN} = 1\mu F$, $C_{OUT} = 2.2\mu F$, $C_{BP} = 0.01\mu F$, $T_A = +25^\circ C$, unless otherwise noted.)

OUTPUT NOISE 10Hz TO 100kHz

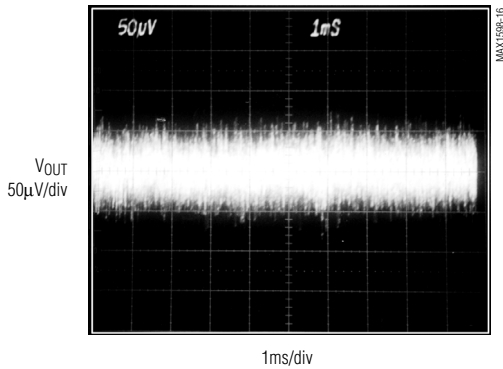

MAX1598E25, $C_{OUT} = 10\mu F$, $I_{LOAD} = 10mA$, $C_{BP} = 0.1\mu F$

REGION OF STABLE C_{OUT} ESR vs. LOAD CURRENT

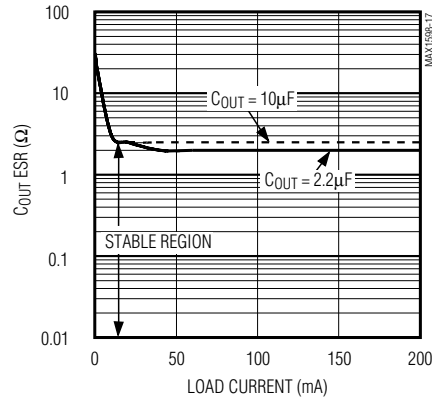

LINE-TRANSIENT RESPONSE

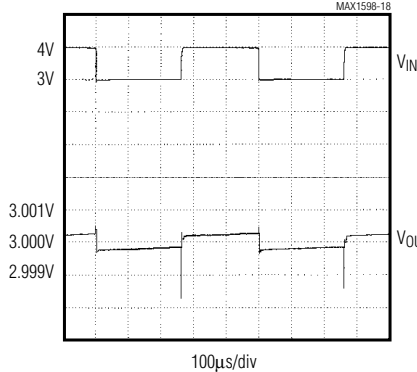

MAX1598E30, $I_{LOAD} = 50mA$

LOAD-TRANSIENT RESPONSE

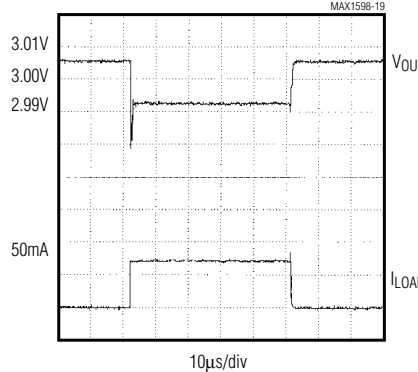

MAX1598E30, $V_{IN} = V_{OUT} + 0.5V$, $C_{IN} = 10\mu F$, $I_{LOAD} = 0$ TO 50mA

LOAD-TRANSIENT RESPONSE NEAR DROPOUT

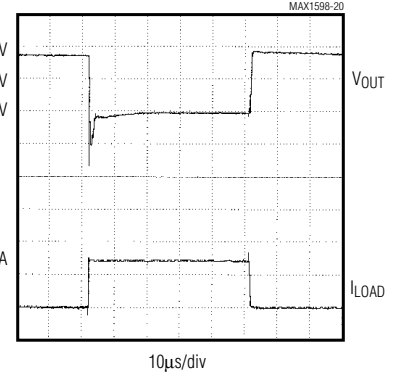

MAX1598E30, $V_{IN} = V_{OUT} + 0.1V$, $C_{IN} = 10\mu F$, $I_{LOAD} = 0$ TO 50mA

MAX1598E25 SHUTDOWN EXIT DELAY

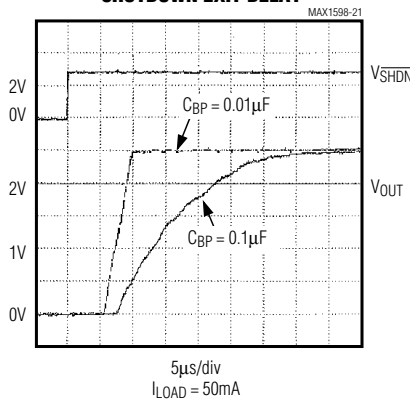

$I_{LOAD} = 50mA$

MAX1598E50 SHUTDOWN EXIT DELAY

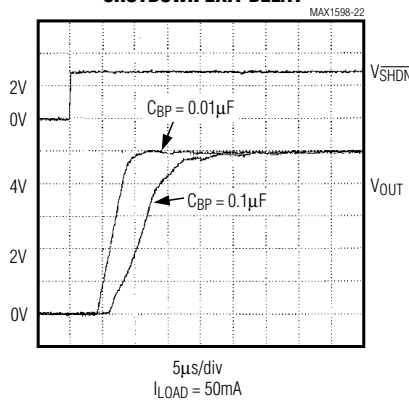

$I_{LOAD} = 50mA$

ENTERING SHUTDOWN

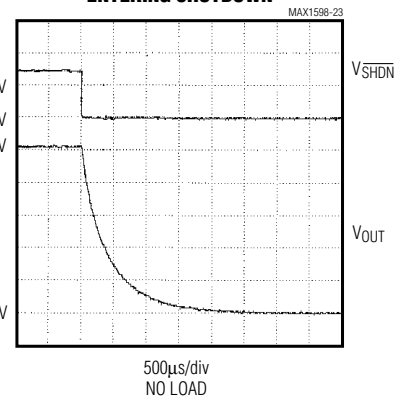

NO LOAD

Low-Noise, Low-Dropout, 200mA Linear Regulator

Pin Description

PIN	NAME	FUNCTION
1	IN	Regulator Input. Supply voltage can range from 2.5V to 6.5V. Bypass with a 1 μ F capacitor to GND (see the <i>Capacitor Selection and Regulator Stability</i> section).
2	GND	Ground. This pin also functions as a heatsink. Solder to a large pad or the circuit-board ground plane to maximize power dissipation.
3	$\overline{\text{SHDN}}$	Active-Low Shutdown Input. A logic low reduces the supply current to 10nA and causes the output voltage to discharge to GND. Connect to IN for normal operation.
4	BP	Reference-Noise Bypass. Bypass with a low-leakage, 0.01 μ F ceramic capacitor for reduced noise at the output.
5	OUT	Regulator Output. Sources up to 200mA. Bypass with a 2.2 μ F (<0.2 Ω typical ESR) capacitor to GND.

Detailed Description

The MAX1598 is a low-noise, low-dropout, low-quiescent-current linear regulator designed primarily for battery-powered applications. The part is available with preset output voltages from 2.5V to 5V in 100mV increments. This device can supply loads up to 200mA. As illustrated in Figure 1, the MAX1598 consists of a 1.25V reference, error amplifier, P-channel pass transistor, and internal feedback voltage-divider.

The 1.25V bandgap reference is connected to the error amplifier's inverting input. The error amplifier compares this reference with the feedback voltage and amplifies the difference. If the feedback voltage is lower than the reference voltage, the pass-transistor gate is pulled

lower, which allows more current to pass to the output and increases the output voltage. If the feedback voltage is too high, the pass-transistor gate is pulled up, allowing less current to pass to the output. The output voltage is fed back through an internal resistor voltage-divider connected to the OUT pin.

An external bypass capacitor connected to the BP pin reduces noise at the output. Additional blocks include a current limiter, reverse battery protection, thermal sensor, and shutdown logic. The MAX1598 also includes an autodischarge function, which actively discharges the output voltage to ground when the device is placed in shutdown mode.

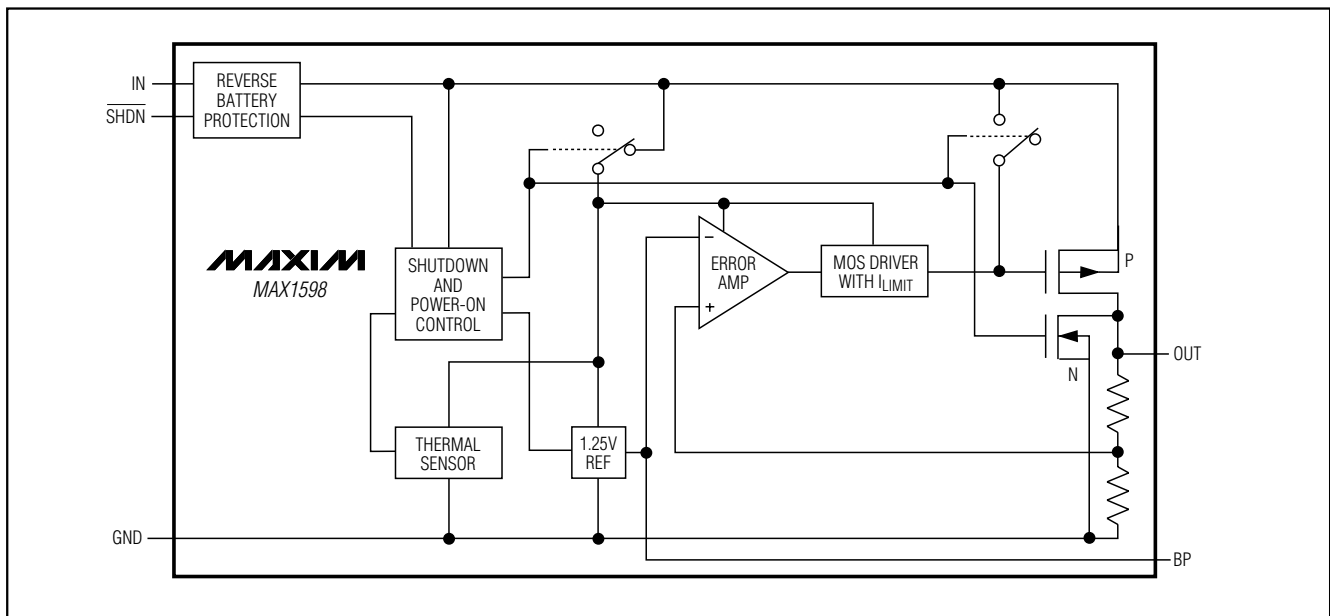

Figure 1. Functional Diagram

Low-Noise, Low-Dropout, 200mA Linear Regulator

Output Voltage

The MAX1598 is supplied with factory-set output voltages from 2.5V to 5V in 100mV increments. Except for the MAX1598EZK29 and the MAX1598EZK32 (which have an output voltage preset at 2.84V and 3.15V, respectively), the two-digit suffix allows the customer to choose the output voltage in 100mV increments. For example, the MAX1598EZK33 has a preset output voltage of 3.3V (see the *Selector Guide*).

Internal P-Channel Pass Transistor

The MAX1598 features a 1.1 Ω typical P-channel MOSFET pass transistor. This provides several advantages over similar designs using PNP pass transistors, including longer battery life. The P-channel MOSFET requires no base drive, which reduces quiescent current considerably. PNP-based regulators waste considerable current in dropout when the pass transistor saturates. They also use high base-drive currents under large loads. The MAX1598 does not suffer these problems and consumes only 100 μ A of quiescent current whether in dropout, light-load, or heavy-load applications (see the *Typical Operating Characteristics*).

Current Limit

The MAX1598 includes a current limiter, which monitors and controls the pass transistor's gate voltage, limiting the output current to 458mA. For design purposes, consider the current limit to be 220mA minimum to 1.1A maximum. The output can be shorted to ground indefinitely without damaging the part.

Thermal-Overload Protection

Thermal-overload protection limits total power dissipation in the MAX1598. When the junction temperature exceeds $T_J = +155^\circ\text{C}$, the thermal sensor signals the shutdown logic, turning off the pass transistor and allowing the IC to cool. The thermal sensor turns the pass transistor on again after the IC's junction temperature cools by 15 $^\circ\text{C}$, resulting in a pulsed output during continuous thermal-overload conditions.

Thermal-overload protection is designed to protect the MAX1598 in the event of fault conditions. For continual operation, do not exceed the absolute maximum junction-temperature rating of $T_J = +150^\circ\text{C}$.

Operating Region and Power Dissipation

The MAX1598 maximum power dissipation depends on the thermal resistance of the case and circuit board, the temperature difference between the die junction and ambient air, and the rate of air flow. The power dissipation across the device is $P = I_{\text{OUT}} (V_{\text{IN}} - V_{\text{OUT}})$. The maximum power dissipation is:

$$P_{\text{MAX}} = (T_J - T_A) / (\theta_{\text{JB}} + \theta_{\text{BA}})$$

where $T_J - T_A$ is the temperature difference between the MAX1598 die junction and the surrounding air, θ_{JB} (or θ_{JC}) is the thermal resistance of the package, and θ_{BA} is the thermal resistance through the PC board, copper traces, and other materials to the surrounding air.

The GND pin of the MAX1598 performs the dual functions of providing an electrical connection to ground and channeling heat away. Connect the GND pin to ground using a large pad or ground plane.

Reverse Battery Protection

The MAX1598 has a unique protection scheme that limits the reverse supply current to 1mA when either V_{IN} or V_{SHDN} falls below ground. Their circuitry monitors the polarity of these two pins and disconnects the internal circuitry and parasitic diodes when the battery is reversed. This feature prevents device damage.

Noise Reduction

An external 0.01 μ F bypass capacitor at BP, in conjunction with an internal 200k Ω resistor, creates an 80Hz lowpass filter for noise reduction. The MAX1598 exhibits 30 μ V_{RMS} of output voltage noise with $C_{\text{BP}} = 0.01\mu\text{F}$ and $C_{\text{OUT}} = 10\mu\text{F}$. This is negligible in most applications. Startup time is minimized by a power-on circuit that pre-charges the bypass capacitor. The *Typical Operating Characteristics* section shows graphs of Noise vs. BP Capacitance, Noise vs. Load Current, and Output Noise Spectral Density.

Applications Information

Capacitor Selection and Regulator Stability

Under normal conditions, use a 1 μ F capacitor on the MAX1598 input and a 2.2 μ F to 10 μ F capacitor on the output. Larger input capacitor values and lower ESRs provide better supply-noise rejection and line-transient response. Reduce noise and improve load-transient response, stability, and power-supply rejection by using large output capacitors. For stable operation over the full temperature range and with load currents up to 200mA, a 2.2 μ F (min) ceramic capacitor is recommended.

Note that some ceramic dielectrics exhibit large capacitance and ESR variation with temperature. With dielectrics such as Z5U and Y5V, it may be necessary to increase the capacitance by a factor of 2 or more to ensure stability at temperatures below -10 $^\circ\text{C}$. With X7R or X5R dielectrics, 2.2 μ F should be sufficient at all operating temperatures. A graph of the Region of Stable C_{OUT} ESR vs. Load Current is shown in the *Typical Operating Characteristics*.

Low-Noise, Low-Dropout, 200mA Linear Regulator

Use a 0.01 μ F bypass capacitor at BP for low output voltage noise. Increasing the capacitance slightly decreases output noise but increases startup time. Values above 0.1 μ F provide no performance advantage and are not recommended (see the Shutdown Exit Delay graphs in the *Typical Operating Characteristics*).

PSRR and Operation from Sources Other than Batteries

The MAX1598 are designed to deliver low dropout voltages and low quiescent currents in battery-powered systems. Power-supply rejection is 63dB at low frequencies and rolls off above 10kHz. See the Power-Supply Rejection Ratio Frequency graph in the *Typical Operating Characteristics*.

When operating from sources other than batteries, improved supply-noise rejection and transient response can be achieved by increasing the values of the input and output bypass capacitors, and through passive filtering techniques. The *Typical Operating Characteristics* show the MAX1598's line- and load-transient responses.

Load-Transient Considerations

The MAX1598 load-transient response graphs (see the *Typical Operating Characteristics*) show two components of the output response: a DC shift from the output impedance due to the load current change, and the transient response. Typical transient for a step change in the load current from 0 to 50mA is 12mV. Increasing the output capacitor's value and decreasing the ESR attenuates the overshoot.

Input-Output (Dropout) Voltage

The regulator's minimum input-output voltage differential (or dropout voltage) determines the lowest usable supply voltage. In battery-powered systems, this determines the useful end-of-life battery voltage. Because the MAX1598 uses a P-channel MOSFET pass transistor, their dropout voltage is a function of drain-to-source on-resistance ($R_{DS(ON)}$) multiplied by the load current (see the *Typical Operating Characteristics*).

Chip Information

TRANSISTOR COUNT: 247

SUBSTRATE CONNECTED TO GND

Selector Guide

OUTPUT VOLTAGE (xy) CODE	PRESET OUTPUT VOLTAGE (V)	SOT TOP MARK
THIN SOT23		MAX1598 THIN
MAX1598EZK25-T	2.50	ADRM
MAX1598EZK28-T	2.80	ADRJ
MAX1598EZK29-T	2.84	ADRN
MAX1598EZK30-T	3.00	ADRO
MAX1598EZK32-T	3.15	ADRP
MAX1598EZK33-T	3.30	ADRQ
MAX1598EZK36-T	3.60	ADRR
MAX1598EZK50-T	5.00	ADRS
Other xy**	x.y0	—

**Other xy between 2.5V and 5V are available in 100mV increments. Contact factory for other versions. Minimum order quantity is 25,000 units.

