



Video Y/C Summer with Driver and Chroma Mute

MAX11503

General Description

The MAX11503 is a low-power video amplifier with a Y/C summer and chroma mute. The device accepts an S-video or Y/C input and sums the luma (Y) and chroma (C) signals into a composite CVBS signal which can be connected directly to a TV monitor. The MAX11503 drives two terminated 75Ω video coax cables.

The MAX11503 features include chroma mute, power save, and SAG correction. Chroma mute disables the chroma buffer. If the device is used to combine Y and C signals in a camera application, the chroma mute may be used in low-light situations. This removes all chroma including burst which causes a downstream composite video decoder to interpret the video signal as luminance only, thus improving image quality. SAG correction allows small output capacitors to be used in AC-coupled output applications.

The MAX11503 operates from a single 2.7V to 5.25V supply, is specified over the extended -40°C to +85°C temperature range, and is available in a small 8-pin μMAX® package.

Applications

Security Cameras
 CCD Cameras
 Digital Cameras
 Portable Media Players

Features

- ◆ Low Operating Voltage
- ◆ Internal Y/C Summer with Chroma Mute Capability
- ◆ AC- or DC-Coupled Inputs
- ◆ AC- or DC-Coupled Outputs
- ◆ Output Buffer Drives Two Terminated 75Ω Video Coax Cables
- ◆ SAG Correction Allows for Small Output Capacitors
- ◆ Low-Power Standby, 0.5μA at 3.0V

Ordering Information

PART	TEMP RANGE	PIN-PACKAGE	PKG CODE
MAX11503EUA+	-40°C to +85°C	8 μMAX-EP*	U8E+2

+ Denotes lead-free package.

*EP = Exposed pad.

Pin Configuration appears at end of data sheet.

Functional Diagram

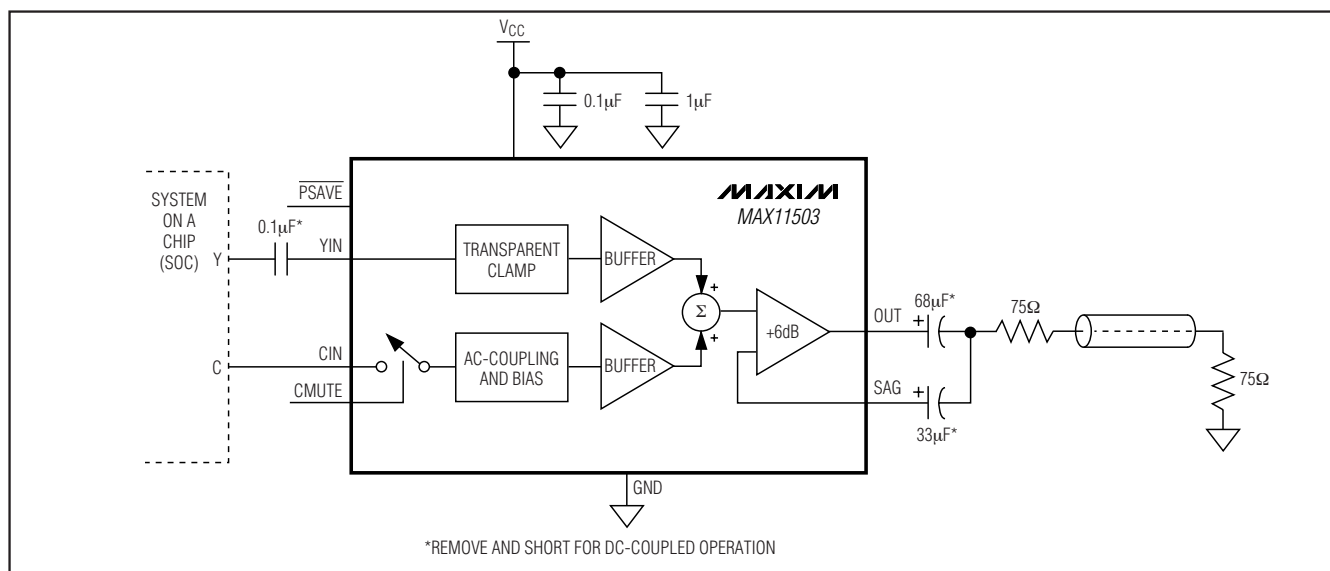

μMAX is a registered trademark of Maxim Integrated Products, Inc.



Maxim Integrated Products 1

For pricing, delivery, and ordering information, please contact Maxim Direct at 1-888-629-4642, or visit Maxim's website at www.maxim-ic.com.

Video Y/C Summer with Driver and Chroma Mute

ABSOLUTE MAXIMUM RATINGS

Any Pin to GND-0.3V to +5.5V
 Maximum Current into Any Pin Except V_{CC} and GND±50mA
 Continuous Power Dissipation (T_A = +70°C)
 8-Pin μMAX-EP
 Single-Layer Board (derate 10.3mW/°C
 above +70°C).....824mW
 Multilayer Board (derate 12.9 mW/°C
 above +70°C).....1030mW

Operating Temperature Range-40°C to +85°C
 Storage Temperature Range-65°C to +150°C
 Lead temperature (soldering, 10s)+300°C
 Junction Temperature+150°C
 ESD Protection (Human Body Model).....±2kV

Stresses beyond those listed under "Absolute Maximum Ratings" may cause permanent damage to the device. These are stress ratings only, and functional operation of the device at these or any other conditions beyond those indicated in the operational sections of the specifications is not implied. Exposure to absolute maximum rating conditions for extended periods may affect device reliability.

ELECTRICAL CHARACTERISTICS

(V_{CC} = 3.0V, V_{PSAVE} = V_{CC}, V_{CMUTE} = 0V, R_L = 150Ω, AC-coupled, T_A = +25°C, unless otherwise noted.)

PARAMETER	SYMBOL	CONDITIONS	MIN	TYP	MAX	UNITS
Operating Current	I _{CC}	Input AC-coupled to ground, no output load, V _{CC} = 2.7V		8		mA
		Input AC-coupled to ground, no output load, V _{CC} = 3.0V		8	14.0	
		Input AC-coupled to ground, no output load, V _{CC} = 5.25V		8		
Supply Voltage Range	V _{CC}		2.70		5.25	V
Operating Temperature Range	T		-40		+85	°C
Operating Current (Power-Save Mode)	I _{CCS}	V _{PSAVE} = 0, V _{CC} = 2.7V		0.5		μA
		V _{PSAVE} = 0, V _{CC} = 3.0V		0.5		
		V _{PSAVE} = 0, V _{CC} = 5.25V		0.5		
Maximum Output Voltage	V _{OM}	V _{CC} = 2.7V		2.0		V _{P-P}
		V _{CC} = 3.0V	2.2			
		V _{CC} = 5.25V		2.4		
Voltage Gain	A _v	V _{CC} = 2.7V		6		dB
		V _{CC} = 3.0V		6		
		V _{CC} = 5.25V		6		
Frequency Characteristic	ΔA _v	Y _{IN} = 100kHz to 5.5MHz, V _{CC} = 2.7V		0		dB
		Y _{IN} = 100kHz to 5.5MHz, V _{CC} = 3.0V	-1	0	+1	
		Y _{IN} = 100kHz to 5.5MHz, V _{CC} = 5.25V		0		
Differential Gain	dG	V _{CC} = 2.7V		0.5		%
		V _{CC} = 3.0V		0.1		
		V _{CC} = 5.25V		0.12		
Differential Phase	dφ	V _{CC} = 2.7V		0.3		Degrees
		V _{CC} = 3.0V		0.3		
		V _{CC} = 5.25V		0.3		

Video Y/C Summer with Driver and Chroma Mute

ELECTRICAL CHARACTERISTICS (continued)

($V_{CC} = 3.0V$, $V_{PSAVE} = V_{CC}$, $V_{CMUTE} = 0V$, $R_L = 150\Omega$, AC-coupled, $T_A = +25^\circ C$, unless otherwise noted.)

PARAMETER	SYMBOL	CONDITIONS	MIN	TYP	MAX	UNITS
Signal-to-Noise Ratio	SNR	Weighted, $V_{CC} = 2.7V$		-65		dB
		Weighted, $V_{CC} = 3.0V$		-62		
		Weighted, $V_{CC} = 5.25V$		-65		
Second Harmonic Distortion	2HD	3.58MHz, $V_{CC} = 2.7V$		-48		dB
		3.58MHz, $V_{CC} = 3.0V$		-48		
		3.58MHz, $V_{CC} = 5.25V$		-48		
Chroma Input Resistance	R_{CIN}			800		k Ω
Logic-Input Voltage Low	V_{IL}				0.6	V
Logic-Input Voltage High	V_{IH}		0.7 x V_{CC}			V

Typical Operating Characteristics

($V_{CC} = 3.0V$, $V_{PSAVE} = V_{CC}$, $V_{CMUTE} = 0V$, $R_L = 150\Omega$, AC-coupled, $T_A = +25^\circ C$, unless otherwise noted.)

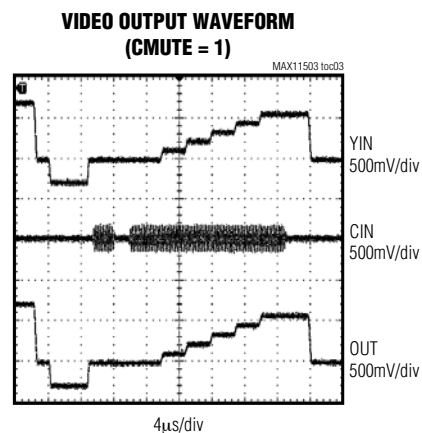
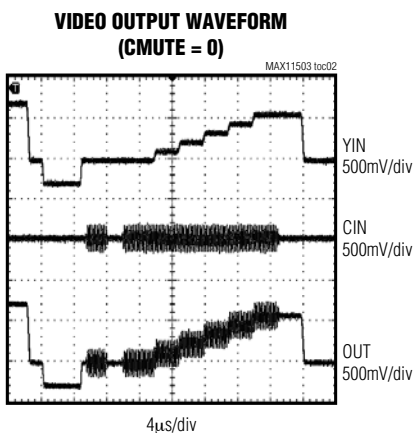
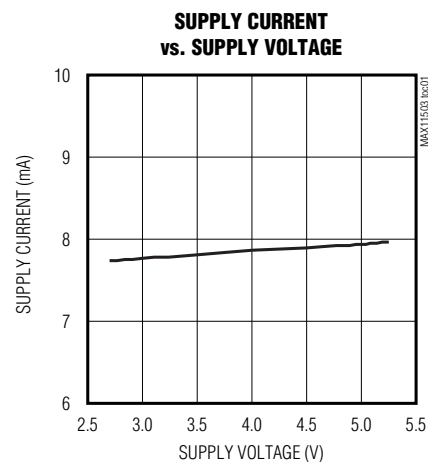

Video Y/C Summer with Driver and Chroma Mute

Typical Operating Characteristics (continued)

($V_{CC} = 3.0V$, $V_{PSAVE} = V_{CC}$, $V_{CMUTE} = 0V$, $R_L = 150\Omega$, AC-coupled, $T_A = +25^\circ C$, unless otherwise noted.)

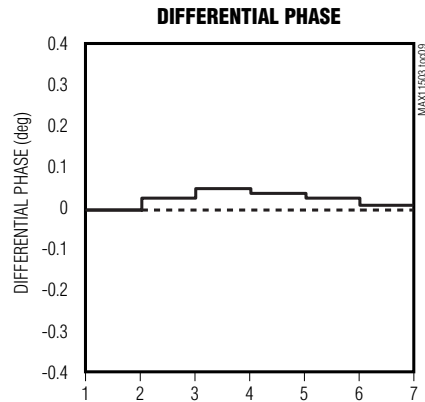
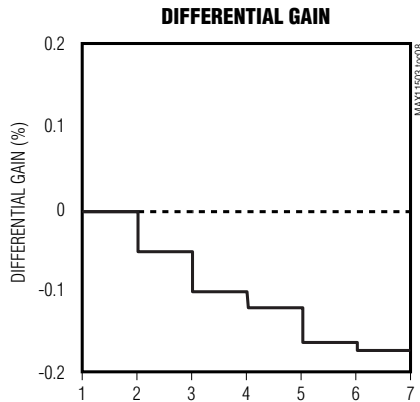
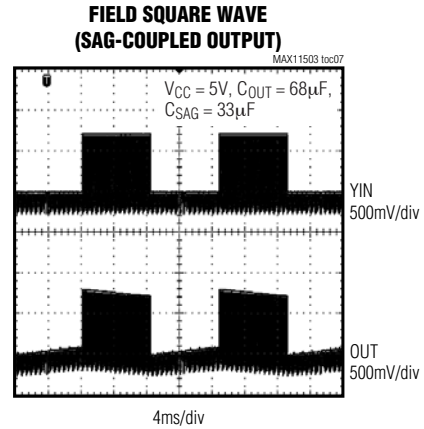
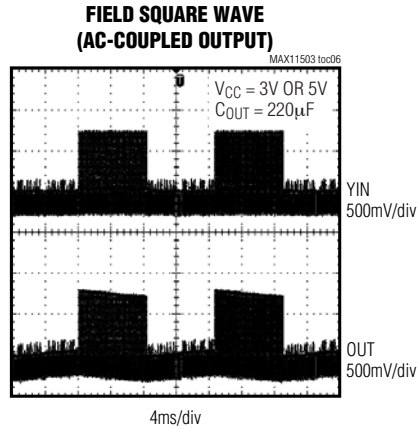
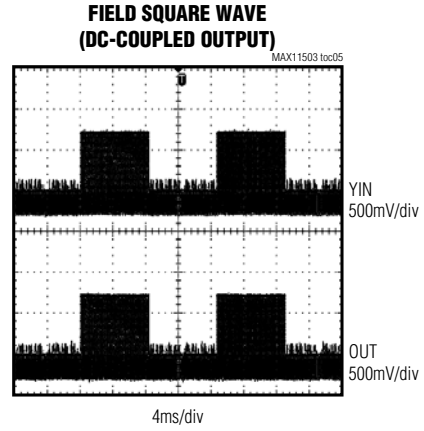
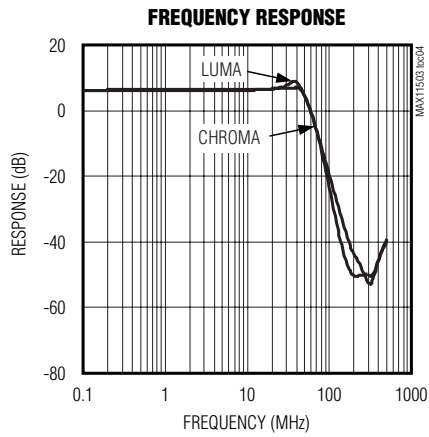

Video Y/C Summer with Driver and Chroma Mute

MAX11503

Pin Description

PIN	NAME	FUNCTION
1	YIN	Luma Input
2	GND	Ground
3	OUT	Video Out
4	SAG	Sag Correction Input. Connect to OUT when AC- or DC-coupling video output. See Figure 1 to determine capacitor value and circuit.
5	V _{CC}	Power Supply. Bypass to GND with 0.1 μ F and 1 μ F capacitors.
6	$\overline{\text{PSAVE}}$	Active-Low Power-Save Logic Input. Connect $\overline{\text{PSAVE}}$ to V _{CC} for normal operation. Drive low to put device into a low-power consumption mode.
7	CMUTE	Chroma Mute Logic Input. Connect CMUTE to ground for normal operation. Drive high to disable the chroma buffer.
8	CIN	Chroma Input
EP	—	Exposed Pad. Connect EP to ground.

Detailed Description

The MAX11503 is a low-power video amplifier with a Y/C summer and chroma mute. The device accepts an S-video or Y/C input and sums the luma (Y) and chroma (C) signals into a composite CVBS signal which can be connected directly to a TV monitor. The MAX11503 drives two terminated 75 Ω video coax cables.

The MAX11503 features chroma mute, power save, and SAG correction. Chroma mute disables the chroma buffer. If the device is used to combine Y and C signals in a camera application, chroma mute may be used in low-light situations. This removes all chroma including burst which causes a downstream composite video decoder to interpret the video signal as luminance only, thus improving image quality. Power-save puts the device into a low-power consumption mode. SAG correction allows small output capacitors to be used in AC-coupled output applications.

The MAX11503 has a transparent clamp at YIN, allowing the luma input to be AC- or DC-coupled. If the luma input is DC-coupled, the sync tip must be at ground and the video signal must be 1V_{P-P}. For low-supply voltages, ensure that the DC level of the input is low enough to avoid clipping at the output. If the luma input is AC-coupled, the clamp adjusts the luma signal's sync tip to ground at YIN. Use an AC-coupling capacitor of 0.1 μ F.

The MAX11503 has an internal AC-coupling capacitor at CIN, allowing the chroma input to be coupled directly to CIN.

Chroma Mute

In applications using cameras that output composite video, the video is always decoded by a downstream composite decoder in a monitor or for further video processing.

In low-light conditions, the camera video signal becomes noisy. The high-frequency (less visible monochrome) noise from the camera is transformed to low-frequency highly visible colored noise by the normal encode and decode blocks of composite video processing. This is caused when the chroma information is encoded onto a high-frequency subcarrier, mixed with the luminance and the decoded. First, high-frequency noise near the color subcarrier is down-converted to low-frequency noise. Second, chroma separation by comb filtering removes luminance noise, but correlates the noise in phase with the chroma to become vertical lines. These two effects cause highly visible and objectional color noise. Hence, using a purely monochrome signal is better looking than a color signal.

When pulled high, the chroma mute input disables all chroma and burst and the device outputs a monochrome video signal. This causes the downstream decoder to recognize the video signal as monochrome.

Power-Save

Asserting $\overline{\text{PSAVE}}$ logic low puts the device into a power-down mode, reducing the supply current to 0.5 μ A and minimizing power consumption. Connect $\overline{\text{PSAVE}}$ to V_{CC} for normal operation.

Video Y/C Summer with Driver and Chroma Mute

Applications Information

Input Configuration

The luma input can be DC-coupled if the sync tip is near ground (see the *Minimum Supply-Voltage Considerations* section). Otherwise, it should be AC-coupled into YIN with a 0.1 μ F capacitor. When the luma input is AC-coupled, the transparent clamp adjusts its sync tip to ground at YIN. Because the chroma input is internally AC-coupled and biased, an external AC-coupling capacitor is not required unless the signal is outside the operating voltage range.

Output-Amplifier Configuration

The output buffer is capable of driving two terminated AC- or DC-coupled 75 Ω video coax cables. With sync tip at the input at ground, the sync tip at the output is offset by +250mV.

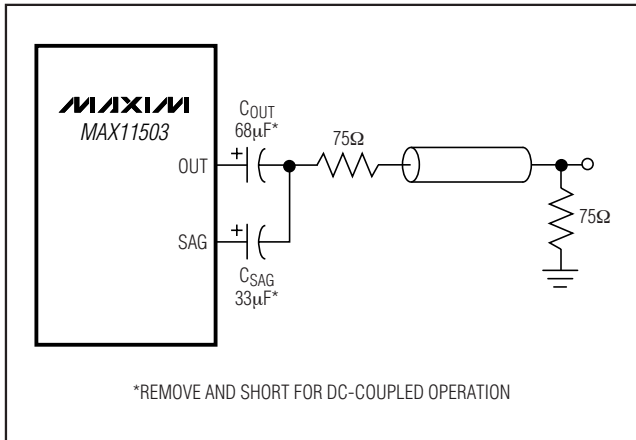

Figure 1. Output with SAG Correction

SAG-Corrected Output

SAG uses feedback to reduce the size of the output AC-coupling capacitor. Without SAG, a 220 μ F AC-coupling capacitor is required to reduce tilt when feeding each terminated 75 Ω coax cable (Figure 2). This sets the highpass -3dB frequency to 5Hz. Using SAG correction with $C_{OUT} = 68\mu\text{F}$ and $C_{SAG} = 33\mu\text{F}$ also achieves a highpass -3dB frequency of 5Hz, but with smaller capacitors (Figure 1).

SAG correction is inherently designed to drive a constant load because the capacitor values vary with the number of loads driven. If the capacitors are chosen for two loads and the end user only connected one, the video tilt would be opposite in sign, but of the same magnitude as not using SAG at all. This would cause excessive video tilt and the failure of the next piece of equipment. The recommended capacitor values for two constant 75 Ω terminated video loads are $C_{OUT} = 120\mu\text{F}$, $C_{SAG} = 68\mu\text{F}$. In addition, SAG feedback pre-distortion function requires about 30% more overhead in the video driver. Hence, use SAG correction only with a typical 5V supply voltage. See the *Minimum Supply-Voltage Considerations* section for calculations.

When SAG is not used, such as with AC- or DC-coupling at the output, the driver can drive two terminated 75 Ω video coaxial cables. Connect SAG to OUT when not using SAG correction.

Traditional AC-Coupled Output

The MAX11503 can also be configured to drive one or two of the familiar terminated AC-coupled video coax cables as shown in Figure 2.

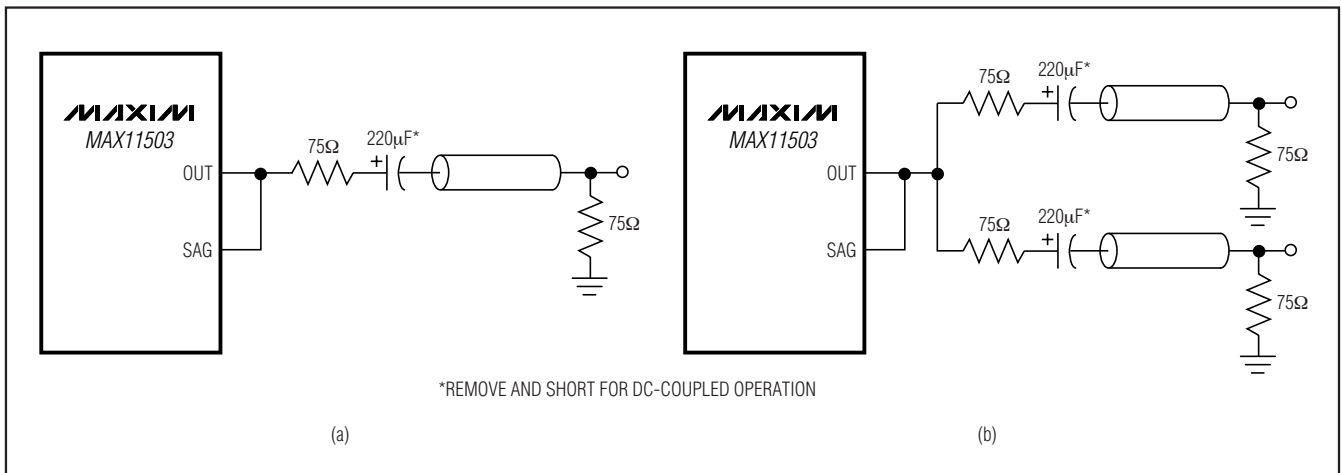

Figure 2. Traditional AC-Coupled Output

Video Y/C Summer with Driver and Chroma Mute

DC-Coupled Output

The MAX11503 input clamps the sync tip of the video signal to 250mV at the IC output, forcing the blanking level to be about 550mV on the coax cables at the termination resistor. This allows driving video to meet digital TV specifications without the need for costly AC-coupling capacitors. Power dissipation is an especially important consideration if DC-coupling one or two terminated video coax cables.

Minimum Supply-Voltage Considerations

The minimum supply voltage depends on the type of video and the output configuration. Use at least the minimum supply voltage to preserve the output amplifier's linearity and video specifications.

The following examples discuss the required minimum supply voltage under several scenarios. Unless otherwise specified, these examples assume:

- 1) The luma input is AC-coupled and therefore the sync tip is clamped at 0.250V at the output.
- 2) The output amplifier needs 0.800V of overhead.

PAL

A PAL test signal is 1.235V_{P-P} (100% color bars). Therefore, the required minimum supply voltage is:

$$V_{CC} = 2 \times 1.235 + 0.250 + 0.800 = 3.5V$$

NTSC

A NTSC signal is 1.0V_{P-P} (75% color bars). Therefore, the required minimum supply voltage is:

$$V_{CC} = 2 \times 1.000 + 0.250 + 0.800 = 3.05V$$

Using SAG Correction

When using SAG correction, the output amplifier needs an overhead of 800mV, in addition to 130% of the maximum video level at the output. Assuming an AC-coupled luma input:

For PAL, the minimum required supply voltage is:

$$V_{CC} = 2 \times 1.235 \times 1.3 + 0.250 + 0.800 = 4.26V$$

For NTSC, the minimum required supply voltage is:

$$V_{CC} = 2 \times 1.000 \times 1.3 + 0.250 + 0.800 = 3.65V$$

Thermal Considerations

The power dissipation for single 75Ω terminated load is 64mW, and for two 75Ω terminated loads is 106mW. As a result of the exposed pad, the temperature rise is minimized.

Short-Circuit Protection

The MAX11503 outputs are fully protected against short circuits either to the ground or the positive supply of the device. The short-circuit protection circuitry limits the output current to 130mA (typical) per output.

PCB Layout Recommendations

The MAX11503 has an exposed pad on the bottom. The pad should be externally connected to ground. Place power-supply decoupling capacitors close to the device with short traces connecting to the power planes. Use ceramic 0.1μF bypass and 1μF bulk capacitors.

For a recommended PCB layout, refer to the MAX11503 EV kit data sheet.

Pin Configuration

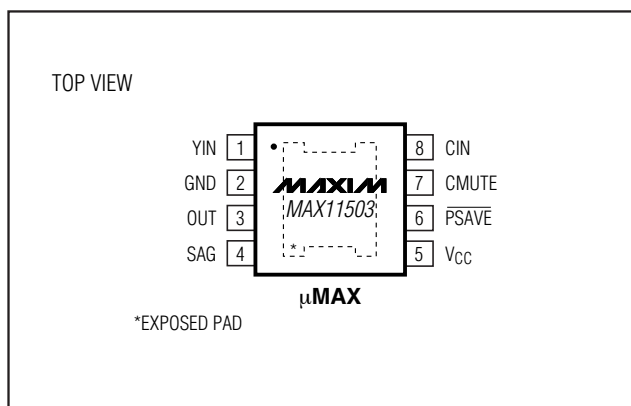

Video Y/C Summer with Driver and Chroma Mute

Package Information

(The package drawing(s) in this data sheet may not reflect the most current specifications. For the latest package outline information, go to www.maxim-ic.com/packages.)

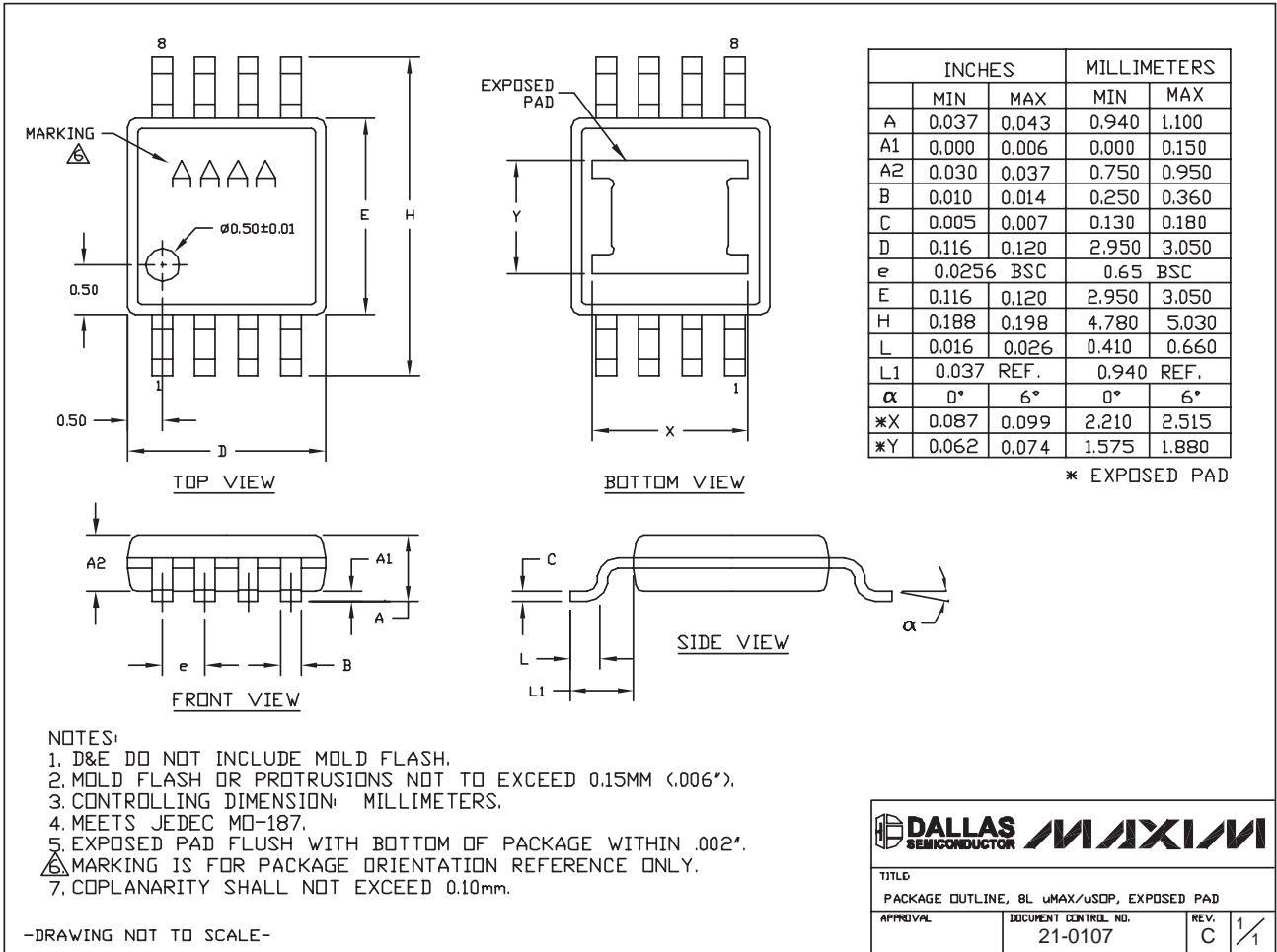

Maxim cannot assume responsibility for use of any circuitry other than circuitry entirely embodied in a Maxim product. No circuit patent licenses are implied. Maxim reserves the right to change the circuitry and specifications without notice at any time.

8 Maxim Integrated Products, 120 San Gabriel Drive, Sunnyvale, CA 94086 408-737-7600