

OPERATION FLOW

The serial receive circuit receives 8-bit serial data, latches the data by an internal latch signal, and then masks inputs from the MCU.

When the code/command circuit receives a command, it sets the display control register to the fixed state, and when it receives a character code, it writes the code to one of 16 display code registers which corresponds to the digit to display. The display controller outputs digit ON/OFF timing pulse to the digit output circuit and selects one character code to display among display code registers. The selected character code is input to either CGROM decoder or CGRAM decoder and then converted into a 35-bit character pattern to input the segment output circuit.

PIN DESCRIPTIONS

Symbol	Pin name	Function
$\overline{\text{RESET}}$	Reset input	This pin is used to initialize the internal state of the M66004.
$\overline{\text{CS}}$	Chip select input	In "L" state, communication with the MCU is possible. In "H" state, any instruction from the MCU is neglected.
SCK	Shift clock input	At the rising edge from "L" to "H", input data is shifted.
SDATA	Serial data input	Character code or command data to display is input from MSB.
XIN, XOUT	Clock input Clock output	This pin is used to connect a resistor and a capacitor externally to set oscillation frequency. (maximum oscillation frequency $f_{osc(max)}=1\text{MHz}$) An external clock can be also connected. In this case, an external clock is connected to pin XIN, and pin XOUT is set to be in open state.
DIG00~ DIG15	Digit output	These pins are used to connect to digit pins of VFD. Pins from DIG00 to DIG15 correspond to digits of VFD from the first digit to the 16th digit.
SEG00~ SEG35	Segment output	These pins are used to connect to segment pins of VFD. Pins from SEG00 to SEG35 correspond to segment pins of VFD as shown in the table below.
P0, P1		Output port (static operation)
VCC1		Positive power supply for internal logic
VCC2		Positive power supply for high-pressure-resistant output port
VSS		GND
VP		Negative power supply for VFD drive

(Connection of segment output pins)

Each □ in the table shows one-dot segment and each figure in □ shows the output segment pin number (from 00 to 35) to connect.

00	01	02	03	04
05	06	07	08	09
10	11	12	13	14
15	16	17	18	19
20	21	22	23	24
25	26	27	28	29
30	31	32	33	34

□
35

DATA TRANSMISSION FORMAT

The MCU transmits 8-bit serial data (MSB-first) to the M66004. In either case of command data or character code data, the M66004 operates by transmitting only one-byte data.

However, in case of character RAM data setting, it is necessary to send 7-byte data continuously.

(Transmission timing)

Standard timing

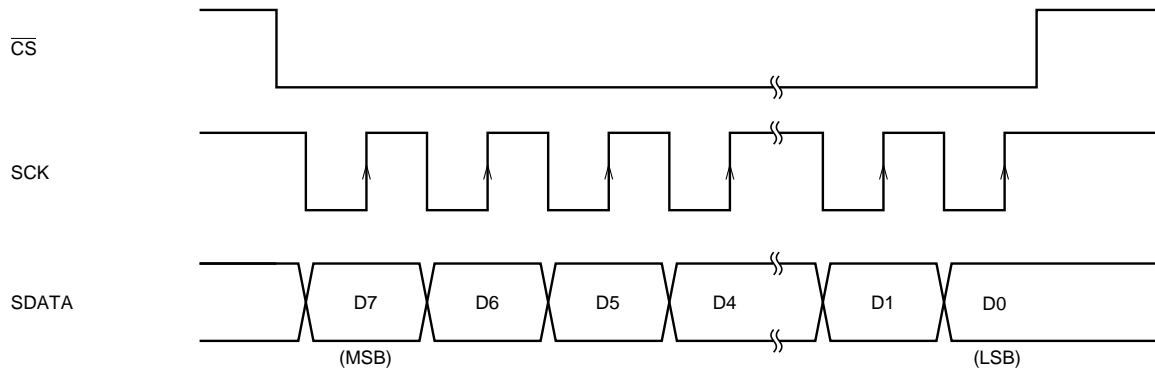

Continuous data transmission timing (In the following example, command data is transmitted and then character codes are transmitted continuously.)

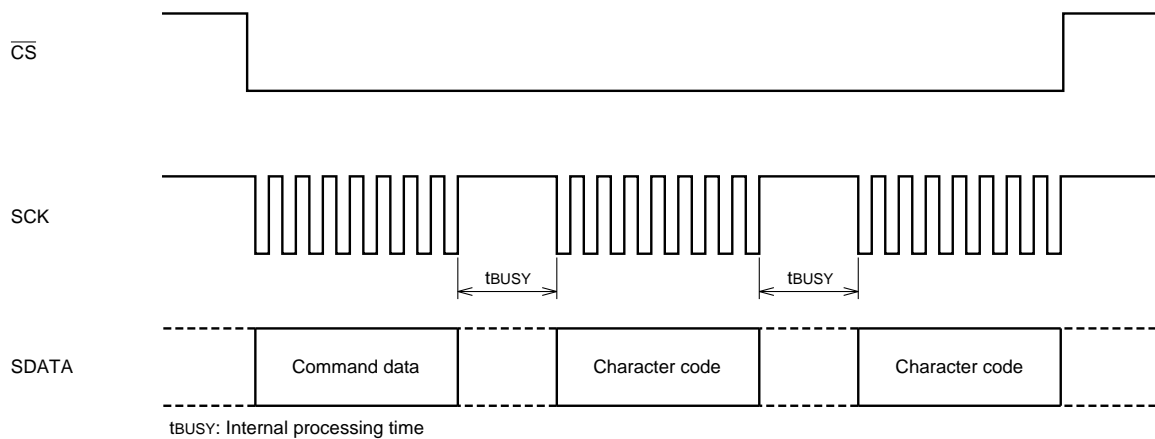

COMMAND LIST

Function	Command code								Contents
	D7	D6	D5	D4	D3	D2	D1	D0	
Display digit length setting	0	0	0	0	0	*	*	*	The number of digits to display is fixed. Eight types of setting (from 9 digits to 16 digits) are possible.
Dimmer value setting	0	0	0	0	1	*	*	*	Eight types of setting (from 1/16 to 14/16) are possible for dimmer value.
One-digit display frequency setting	1	1	1	1	0	1	1	*	Either 128/fosc or 256/fosc is selected as one-digit display frequency.
Display digit setting	1	1	1	0	*	*	*	*	The first character code received after executing this command is displayed as designated by this command.
Auto increment setting	1	1	1	1	0	1	0	*	This command is executed to set or cancel the automatic display digit increment function.
Cursor ON	0	0	0	1	*	*	*	*	This command is executed to make SEG35 ON.
Cursor OFF	1	0	0	0	*	*	*	*	This command is executed to make SEG35 OFF.
All digit display ON/OFF	1	1	1	1	0	0	*	*	This command is executed to make all-digit display OFF or all-digit/segment display ON.
Write to user RAM	1	1	1	1	1	1	×	×	Character data is written into RAM for user definition.
Output port state setting	1	1	1	1	1	0	*	*	Output ports P0 and P1 are set or reset.

×: Optional

*: Refer to the description of command.

DESCRIPTION OF COMMAND

1. Display digit length setting

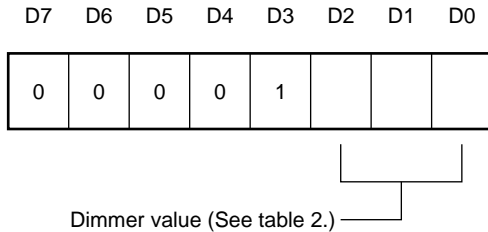

Table 1 Display digit length

D2	D1	D0	Display digit length
0	0	0	9
0	0	1	10
0	1	0	11
0	1	1	12
1	0	0	13
1	0	1	14
1	1	0	15
1	1	1	16

2. Setting of dimmer value and one-digit display frequency(T_{dsp})

1) Dimmer value setting



2) One-digit display frequency (T_{dsp}) setting

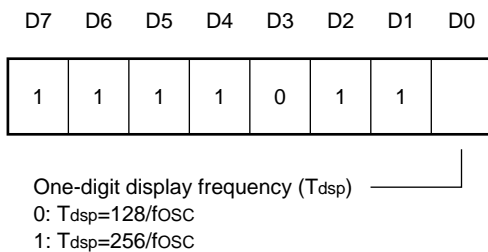

3. Display digit setting, setting and cancel of auto increment

1) Display digit setting



2) Setting and cancel of auto increment

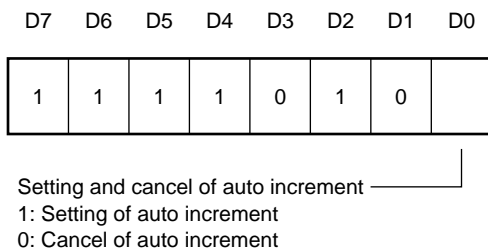

Note 1: When the display digit is defined as N, N equals [decimal values to which D3, D2, D1 and D0 are converted + 1]. In case of (D3, D2, D1, D0)=(1, 0, 0, 0), N is 9. The first character code received after executing this command is spoiled to the 9th digit.

Table 2 Dimmer value

D2	D1	D0	Dimmer value (T _{dig} /T _{dsp})
0	0	0	1/16
0	0	1	2/16
0	1	0	4/16
0	1	1	6/16
1	0	0	8/16
1	0	1	10/16
1	1	0	12/16
1	1	1	14/16

T_{dig}: One-digit-ON pulse width
T_{dsp}: One-digit display frequency

4. All-digit display ON/OFF

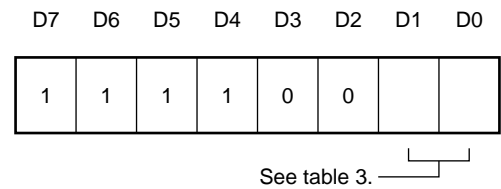
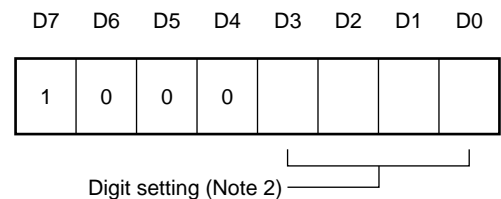

Table 3 ON/OFF control

D1	D0	Operation
×	0	All-digit display OFF (All-OFF)
0	1	Normal operation mode setting
1	1	All-digit/segment display ON (All-ON)

×: Don't care

5. Cursor OFF (SEG35 output OFF)



6. Cursor ON (SEG35 output ON)

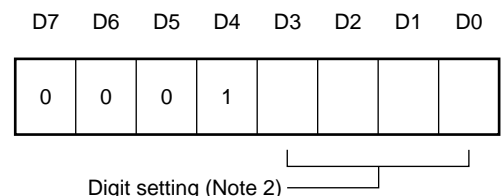

Note 2: The digit to which the cursor to make display ON or OFF belongs is designated. When digit is defined as N, N equals [decimal values to which D3, D2, D1 and D0 are converted + 1]. In case of (D3, D2, D1, D0)=(1, 0, 0, 0), N is 9. ON/OFF control of the cursor which belongs to the 9th digit is possible.

7. Write to character RAM for user definition

Segment ON/OFF data is written into the character RAM for user definition (35 bits). After write to RAM is declared at the first byte, RAM is selected at the second byte and ON/OFF data is transmitted at the 3rd to 7th byte. Therefore, write to RAM is executed by a 7-byte command. Character codes from RAM1 to RAM 16 are assigned to data from 90₁₆ to 9F₁₆ respectively.

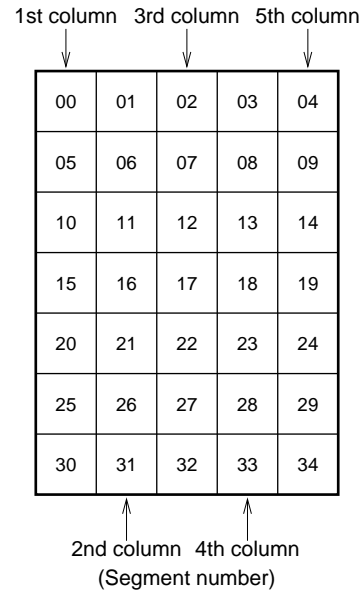
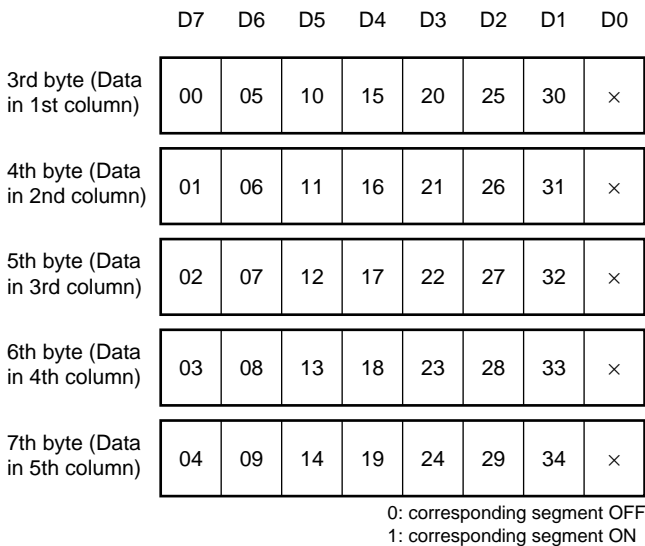
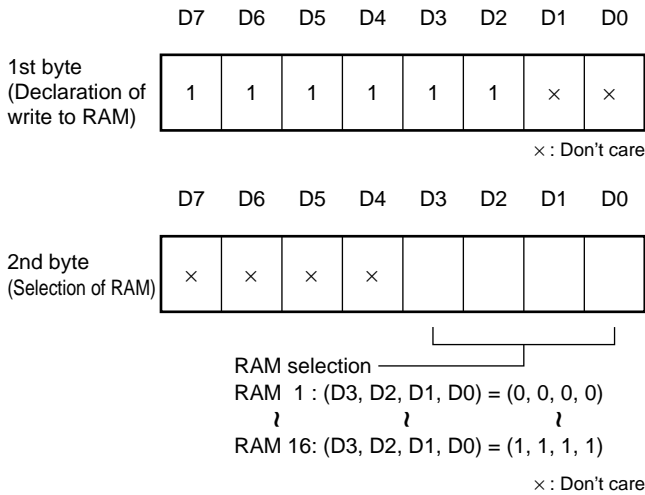

Ex. In order to define "F" (see the figure) as character RAM 1, 7-byte data as shown in the following table should be transmitted in serial order.

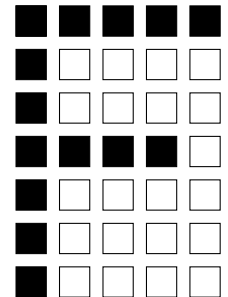

	Transmission data	Remarks
1	FC ₁₆	Declaration of write to RAM 1
2	00 ₁₆	Selection of RAM 1
3	FE ₁₆	Setting of 1st-column segment data
4	90 ₁₆	Setting of 2nd-column segment data
5	90 ₁₆	Setting of 3rd-column segment data
6	90 ₁₆	Setting of 4th-column segment data
7	80 ₁₆	Setting of 5th-column segment data

All optional bits are set to "0".

8. Output port setting

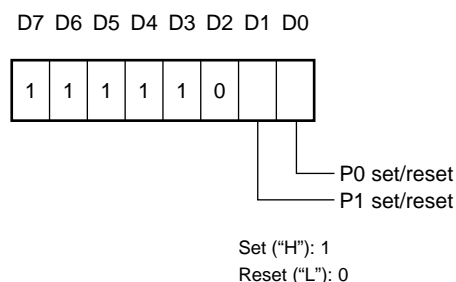

DESCRIPTION OF FUNCTION

1. Display digit length setting

The display digit length can be set within the range from 9-digit to 16-digit according to the number of digits of VFD. In case that the display digit length is set to 12 when a 16-digit VFD is used, digits from 13 to 16 are displayed as blank.

2. Dimmer value and one-digit display frequency (T_{dsp}) setting

Regarding dimmer value, 8-stage setting is possible. One-

digit display scan time (T_{dsp}) can be set to either T_{dsp}=128/fOSC or T_{dsp}=256/fOSC.

Scan cycle time T is set to T=T_{dsp} × N (N: display digit length).

Ex. fOSC=455kHz, N=16

T_{dsp}=281μs, T=4.5ms (222Hz) or T_{dsp}=562μs, T=9.0ms (111Hz)

DISPLAY TIMING

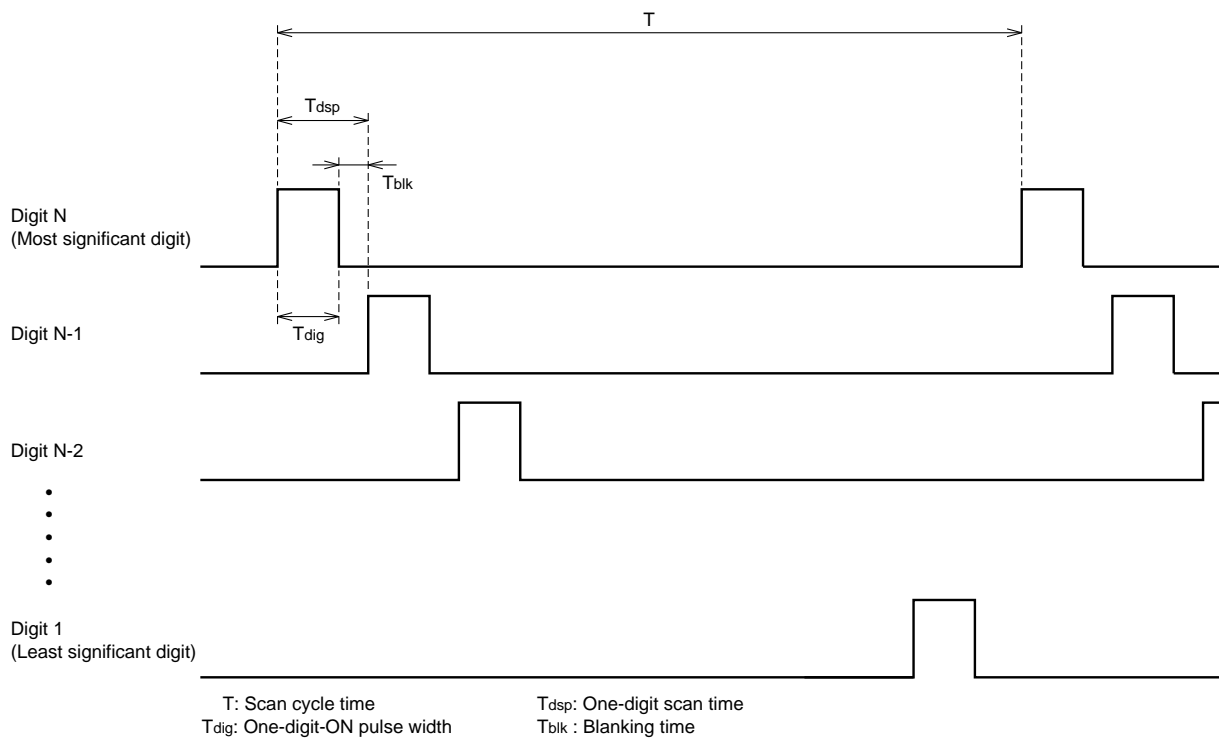

3. Character display

A character (refer to the character code table) which corresponds to the character code transmitted from the MCU is displayed as the designated digit.

The display digit is designated by the display digit setting command. In case that the display digit designated by this command is set to increase automatically, the display digit is automatically increased by 1. After a character is displayed to the most significant digit, it is displayed to the least significant digit.

When the auto increment setting is canceled, the display digit is fixed.

Ex. In order to display a character A to digits 14, 15, 16, 1 and 2 in this order and characters A, B and C to digit 8 successively, 12-byte data must be transmitted in the following order.

(Display digit length = 16)
 A (code 41₁₆)
 B (code 42₁₆)
 C (code 43₁₆)

	Transmission data	Display digit	Remarks
1	F5 ₁₆	–	Setting of auto increment
2	ED ₁₆	–	Display digit is set to the 14th digit.
3	41 ₁₆	14	Transmission of character code
4	41 ₁₆	15	
5	41 ₁₆	16	
6	41 ₁₆	1	
7	41 ₁₆	2	
8	F4 ₁₆	–	Cancel of auto increment setting
9	E7 ₁₆	–	Display digit is set to the 8th digit.
10	41 ₁₆	8	Transmission of character code
11	42 ₁₆	8	
12	43 ₁₆	8	

4. All-digit display ON/OFF

All digits are simultaneously lighted or put off by inputting all-digit display ON command or all-digit display OFF command. When all-digit display ON command is transmitted, all digits including a cursor and all segments are lighted.

Therefore, this command can be used for the lamp test. When all-digit display ON setting is canceled (normal operation mode is selected), all digits are displayed according to the setting before all-digit display ON operation. It is also possible to set the next character to the designated digit during the all-digit display ON operation.

When all-digit display OFF command is transmitted, all digits including a cursor are put off. When all-digit display OFF setting is canceled (normal operation mode is selected), all digits are displayed according to the setting before all-digit display OFF operation. It is also possible to set the next character to the designated digit in the all-digit display OFF state.

OPERATION AT RESET

When a reset signal is input, the internal state is initialized as shown in Table 4.

Table 4 Initial state

Contents	Setting after reset
Display (characters and cursor)	All digits: OFF
Display digit length, dimmer value, display digit, one-digit display frequency, user character RAM state, auto increment setting	Values immediately before reset are held.
Serial receive circuit	Reset
Output port setting	Set

ABSOLUTE MAXIMUM RATINGS

Symbol	Parameter		Conditions	Ratings	Unit
VCC	Supply voltage	VCC1, VCC2		-0.3 ~ + 7	V
VP	Pull-down voltage		(Note 3)	VCC-45 ~ VCC + 0.3	V
VI	Input voltage			-0.3 ~ VCC + 0.3	V
VO	Output voltage	XOUT, P0, P1		-0.3 ~ VCC + 0.3	V
Pd	Maximum power dissipation	SP	Any external circuits are not connected to the IC. Ta=25°C (Note 4)	1.6	W
		FP	The IC is mounted on a board. Ta=25°C (Note 5)	1.4	
Tstg	Storage temperature			-65 ~ 150	°C

Notes 3: Frequency of pulse waveform exceeding VCC-40V:450µs or above, pulse width: 30µs or below, output load: CL≤200pF

4: When Ta is 25°C or above, derating (12.8mW/°C) should be conducted.

5: When Ta is 25°C or above, derating (11.2mW/°C) should be conducted.

RECOMMENDED OPERATIONAL CONDITIONS (Ta=-10 ~ 70°C unless otherwise noted)

Symbol	Parameter	Conditions	Limits			Unit
			Min.	Typ.	Max.	
VCC	Supply voltage	VCC1, VCC2	4.5	5	5.5	V
VP	Pull-down voltage		VCC-40		VCC	V
VSS	Supply voltage			0		V
VI	Input voltage		0		VCC	V
Topr	Operating temperature		-10		70	°C

DC CHARACTERISTICS (Ta = -10 ~ 70°C, VCC = 5V ± 10%, VSS = 0V)

Symbol	Parameter	Conditions	Limits			Unit	
			Min.	Typ.	Max.		
VIH	"H" input voltage	SDATA	0.7VCC			V	
VIL	"L" input voltage				0.3VCC	V	
VT+	Positive direction threshold voltage	RESET	0.35VCC	2.8	0.7VCC	V	
VT-	Negative direction threshold voltage	CS SCK, XIN	0.2VCC	2	0.55VCC	V	
IiH	"H" input current		Vi=VCC		1	µA	
IiL	"L" input current		Vi=0V		-1	µA	
VOH	"H" output voltage	DIG output	IOH=-20mA	VCC-2		V	
		SEG output	IOH=-5mA	VCC-2			
		P0, P1	IOH=-2mA	VCC-0.8			
VOL	"L" output voltage	P0, P1	IOl=2mA		0.55	V	
Io	Output pull-down current	DIG, SEG	VP=VCC-40V, Vo=VCC	250	500	850	µA
ICC	Positive supply current	VCC1, VCC2	Vi=0V, Output pin: open VP=VCC-40V			100	µA
			Output pin: open Output "H", clock stop VP=VCC-40V			40	mA
IP	Negative supply current	VP	Output pin: open Output "H", clock stop VP=VCC-40V			-40	mA

Note 6: Total of current at pin VCC1 and current at pin VCC2.

TIMING CONDITIONS ($T_a = -10 \sim 70^\circ\text{C}$, $V_{cc} = 5V \pm 10\%$, $V_{ss} = 0V$)

Symbol	Parameter		Conditions	Limits			Unit
				Min.	Typ.	Max.	
t _c	Clock cycle time	SCK		500			ns
		XIN		1000			
t _{WH}	Clock cycle pulse width	SCK		230			ns
		XIN		460			
t _{WL}	Clock low pulse width	SCK		230			ns
		XIN		460			
t _{su(D)}	SDATA setup time			130			ns
t _{h(D)}	SDATA hold time			100			ns
t _{su(CS)}	$\overline{\text{CS}}$ setup time			0			ns
t _{h(CS)}	$\overline{\text{CS}}$ hold time			130			ns
t _{BUSY} (Note 7)	Internal processing time					6	1/fosc

Note 7: This shows the internal operation time after receiving the serial data. Next data is prohibited in this period. Next data is available after 6T of the operation clock.

OSCILLATION CHARACTERISTICS ($T_a = -10 \sim 70^\circ\text{C}$, $V_{cc} = 5V \pm 10\%$, $V_{ss} = 0V$)

Symbol	Parameter	Conditions	Limits			Unit
			Min.	Typ.	Max.	
fosc	Oscillation frequency	C=100pF, R=27kΩ		500		kHz

TIMING WAVEFORM (Reference voltage: 0.3V_{CC}, 0.7V_{CC})

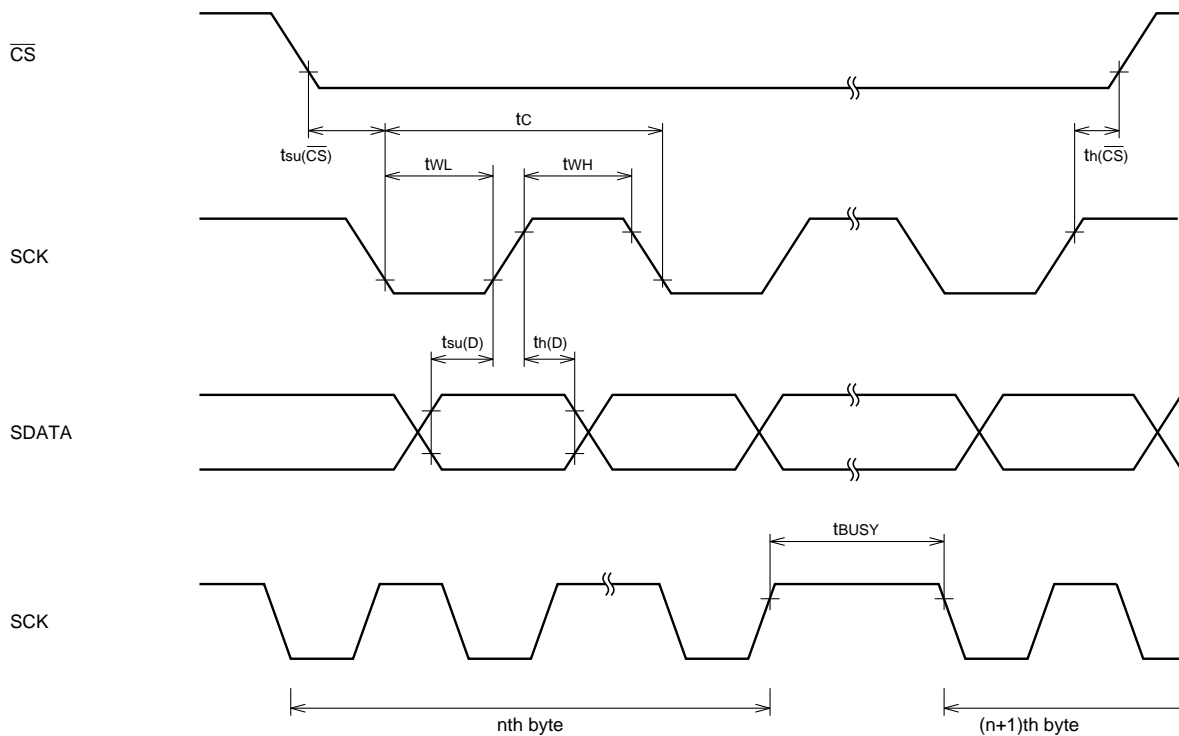

OPERATION FLOWCHART (Initial setting operation)

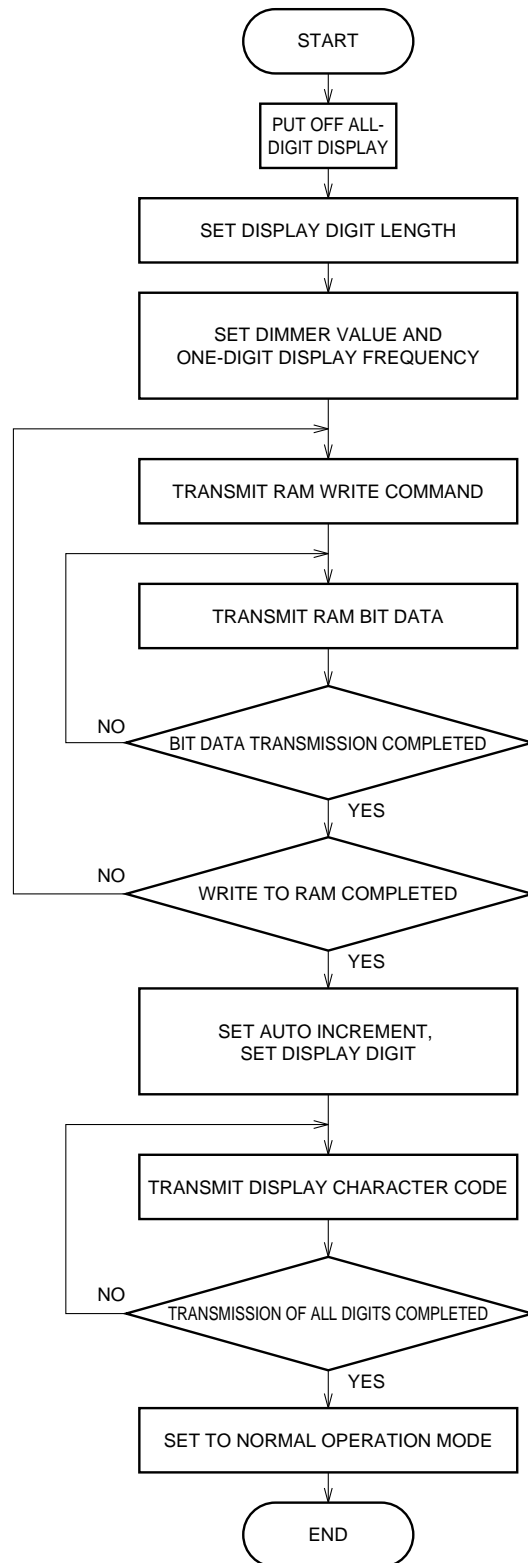

CHARACTER CODE LIST (conforming to JIS-C-6220)

Lower codes \ Upper codes	0000 (0 ₁₆)	0001 (1 ₁₆)	0010 (2 ₁₆)	0011 (3 ₁₆)	0100 (4 ₁₆)	0101 (5 ₁₆)	0110 (6 ₁₆)	0111 (7 ₁₆)	1000 (8 ₁₆)	1001 (9 ₁₆)	1010 (A ₁₆)	1011 (B ₁₆)	1100 (C ₁₆)	1101 (D ₁₆)	1110 (E ₁₆)	1111 (F ₁₆)
0000 (0 ₁₆)			SPACE	0	1	2	3	4		RAM1	SPACE	0	1	2		
0001 (1 ₁₆)			!	2	3	4	5	6		RAM2	7	8	9	A		
0010 (2 ₁₆)			;	4	5	6	7	8		RAM3	9	A	B	C		
0011 (3 ₁₆)			*	6	7	8	9	A		RAM4	B	C	D	E		
0100 (4 ₁₆)			#	8	9	A	B	C		RAM5	D	E	F	G		
0101 (5 ₁₆)			\$	A	B	C	D	E		RAM6	F	G	H	I		
0110 (6 ₁₆)			%	B	C	D	E	F		RAM7	G	H	I	J		
0111 (7 ₁₆)			&	C	D	E	F	G		RAM8	H	I	J	K		
1000 (8 ₁₆)			'	E	F	G	H	I		RAM9	I	J	K	L		
1001 (9 ₁₆)			(F	G	H	I	J		RAM10	J	K	L	M		
1010 (A ₁₆))	H	I	J	K	L		RAM11	K	L	M	N		
1011 (B ₁₆)			*	I	J	K	L	M		RAM12	L	M	N	O		
1100 (C ₁₆)			+	J	K	L	M	N		RAM13	M	N	O	P		
1101 (D ₁₆)			,	K	L	M	N	O		RAM14	N	O	P	Q		
1110 (E ₁₆)			-	L	M	N	O	P		RAM15	O	P	Q	R		
1111 (F ₁₆)			.	M	N	O	P	Q		RAM16	P	Q	R	S		

Note: Character codes which can be defined by users are 160 codes from 20₁₆ to 7F₁₆ and from A0₁₆ to DF₁₆. Codes except those from 20₁₆ to 7F₁₆ and from 90₁₆ to DF₁₆ are command codes.

APPLICATION EXAMPLE

