

Features

- LO & RF: 10 TO 1600 MHz
- IF: DC TO 800 MHz
- LO DRIVE: +13 dBm (NOMINAL)
- HIGH ISOLATION: 40 dB (TYP.)

Description

The M2B is a double balanced mixer, designed for use in military, commercial, and test equipment applications. The design utilizes Schottky ring quad diodes and broadband ferrite baluns to attain excellent performance. This mixer can also be used as a phase detector and/or bi-phase modulator since the IF port is DC coupled to the diodes. Environmental screening is available to MIL-STD-883, MIL-STD-202, or MIL-DTL-28837, consult factory.

Ordering Information

Part Number	Package
M2B	TO-8
M2BC	SMA Connectorized

Product Image

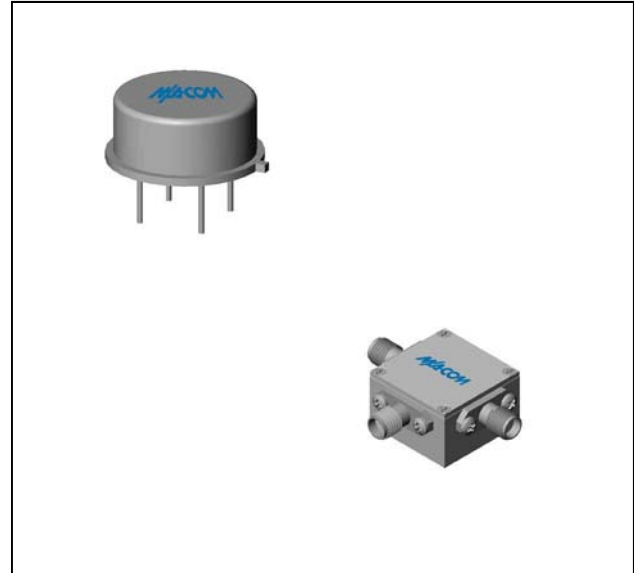

Electrical Specifications: $Z_0 = 50\Omega$ $Lo = +13$ dBm (Downconverter application only)

Parameter	Test Conditions	Units	Typical	Guaranteed	
				+25°C	-54° to +85°C *
SSB Conversion Loss (max) & SSB Noise Figure (max)	fR = 0.02 to 0.6 GHz, fL = 0.01 to 0.8 GHz, fl = 0.0004 to 0.2 GHz fR = 0.01 to 1.6 GHz, fL = 0.01 to 1.6 GHz, fl = 0.0004 to 0.8 GHz	dB	7.0	8.0	8.5
			8.0	9.0	9.5
Isolation, L to R (min)	fL = 0.01 to 0.7 GHz	dB	50	40	38
	fL = 0.7 to 1.2 GHz	dB	45	30	28
	fL = 1.2 to 1.6 GHz	dB	35	25	23
Isolation, L to I (min)	fL = 0.01 to 0.7 GHz	dB	40	30	28
	fL = 0.7 to 1.2 GHz	dB	30	20	18
	fL = 1.2 to 1.6 GHz	dB	25	18	16
1 dB Conversion Comp.	fL = +13 dBm	dBm	+7		
Input IP3		dBm	+22		

* The M2BC specification limits apply at 0°C to +50°C.

Typical Performance Curves

Conversion Loss

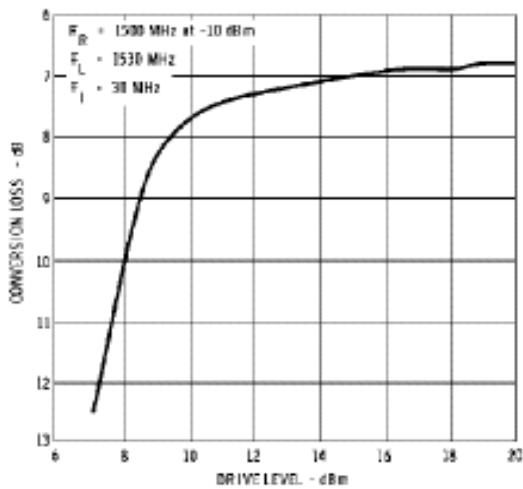

Isolation

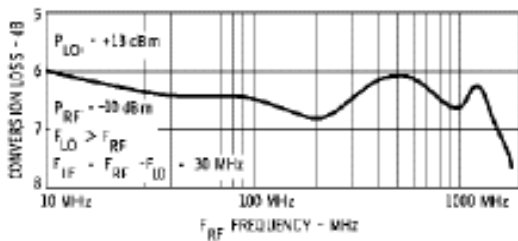
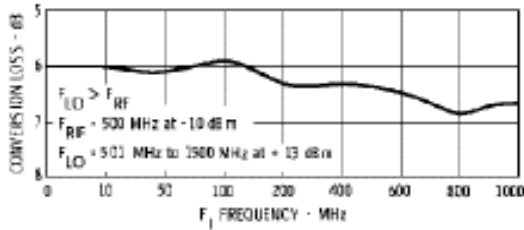
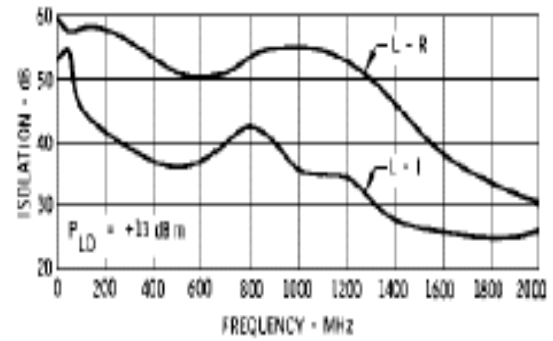

Double-Balanced Mixer

Rev. V5

Absolute Maximum Ratings

Parameter	Absolute Maximum
Operating Temperature	-54°C to +100°C
Storage Temperature	-65°C to +100°C
Peak Input Power	+23 dBm max @ +25°C +17 dBm max @ +100°C
Peak Input Current	50 mA DC

Outline Drawing: TO-8 *

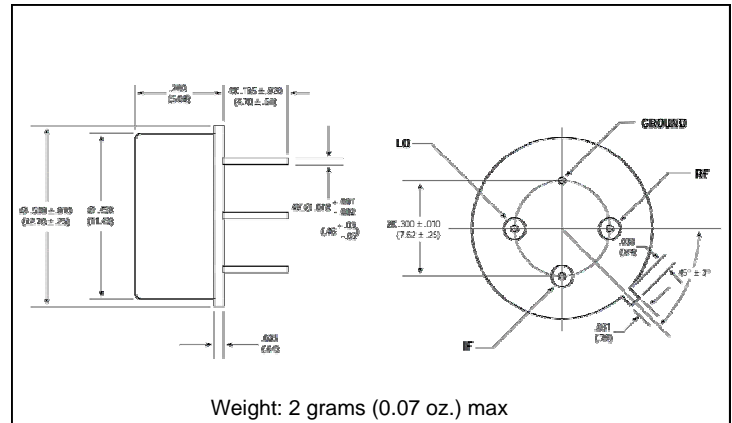

Outline Drawing: SMA Connectorized *

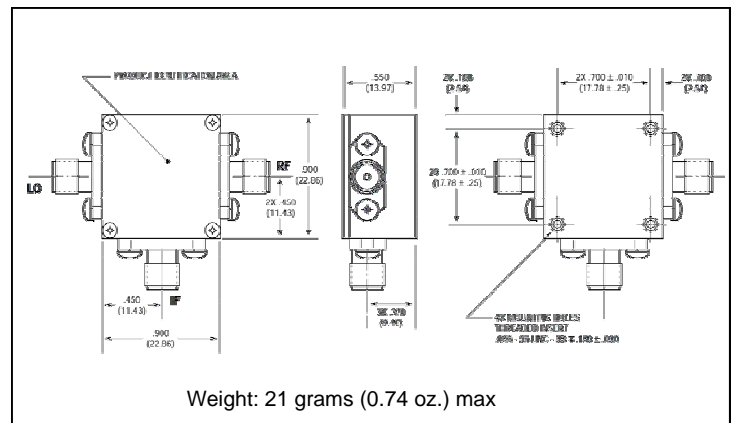

* Dimensions are inches (millimeters) ±0.015 (0.38) unless otherwise specified.